

# CLEANROOMS+



Innovative Solutions for High-Technology

# MODULAR CLEANROOMS

## SIX APPLICATION-SPECIFIC DESIGNS:

HARDWALL CLEANROOMS (shown; page 6)

BIOSAFE® BIO-PHARMACEUTICAL CLEANROOMS (page 10)

SOFTWALL CLEANROOM (page 14)

VALULINE™ SOFTWALL & HARDWALL CLEANROOMS (page 15)

EZ-UP CLEANROOM™ (page 16)

USP<797> CLEANROOMS (page 26)

Cover Photo: Hardwall Modular Cleanroom with furnishings:  
Labconco Basic 47 Fume Hood (No. 3646-00)  
WhisperFlow Hood (No. 1686-60C)  
Stainless Steel Top Workstation (No. 1521-55)  
Cleanroom Polymer Cart (No. 1532-53A)

Note: All prices and specifications are subject to change without notice. Crating charges apply to selected items. Call for information.

© 2016 Terra Universal, Inc. All rights reserved  
Printed in USA 061516



CONVERT ANY SPACE INTO A CONTROLLED ENVIRONMENT AT A FRACTION OF THE COST, IN A FRACTION OF THE TIME!

# SYSTEM OVERVIEW

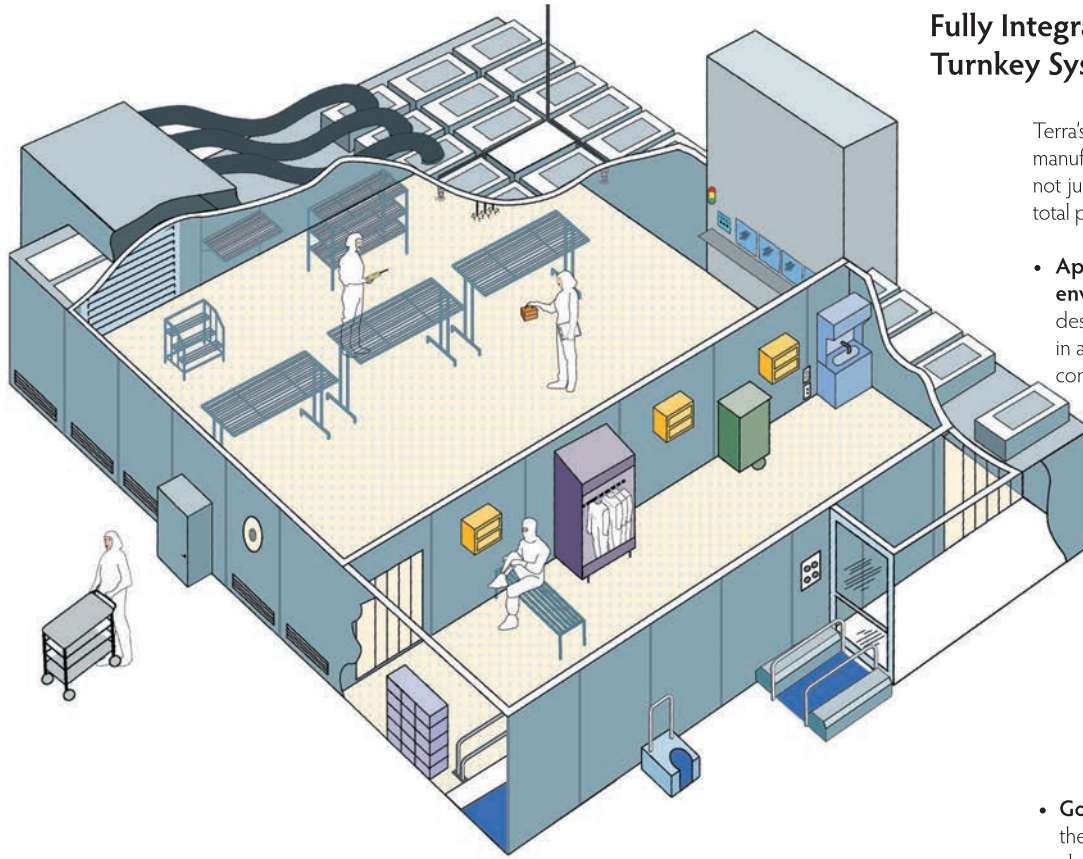

## Fully Integrated, Pre-Tested Turnkey Systems

Terra's integrated design and manufacturing know-how lets you specify not just a clean work environment, but a total production solution:

- **Application-appropriate environment**—Over 35 years of design and manufacturing experience in all areas of environmental control: particles, humidity, static, temperature
- **Work Stations**—Ergonomic, space-saving, ultra-clean designs, including laminar flow and exhaust purification systems
- **Pass-Through Chambers**—Dozens of UL-listed designs and configurations include Fire-Rated, aseptic BioSafe®, and Roll-Up Door models.
- **Gowning Area Furnishings**—From the recognized industry leader in change room design and garbing protocol

Freestanding steel structures span up to 24 feet without external supports.



## How Clean is Clean? Guidelines for FFU Selection

Class 1 and Class 10 applications require 100% ceiling coverage of fan/filter units (FFUs), producing a laminar flow of clean air traveling downward at a velocity of about 90 feet/minute (measured 6" below the filter face). This design ensures a positive pressure inside the cleanroom, which blocks the influx of contaminants and guarantees swift removal of particles generated by people or process equipment.

For less critical contamination requirements, experts correlate ventilation efficiency (i.e., the ability to remove contaminants and meet a cleanliness standard) with both the velocity of filtered air passing through the room and also the number of air changes completed in a given time. The air-change figures

are usually expressed as a range (see Table 1).

Low-end figures within each contamination class generally indicate air velocity and air change requirements for an "as built" or "at rest" facility. In the presence of higher degrees of contamination more air changes are required to maintain the desired cleanliness standard. In fact, many manufacturers insist on as many as 720 air changes per hour to meet ISO 4

(class 10) or cleaner requirements. Once you have established the required air change figure, use this formula to calculate the number of FFUs required:

$$\text{No. of FFUs} = (\text{Air Changes/Hour} \div 60) \times (\text{Cubic ft. in room} \div 650^*)$$

\*CFM output of a loaded 2' x 4' FFU.

See [TerraUniversal.com](http://TerraUniversal.com) for full application guidelines.

**Table 2:**  
Recommended Ceiling Filter Coverage

Class	Ceiling Coverage
ISO 8 (Class 100,000)	5 - 15%
ISO 7 (Class 10,000)	15 - 20%
ISO 6 (Class 1,000)	25 - 40%
ISO 5 (Class 100)	35 - 70%
ISO 4 (Class 10)	50 - 90%
ISO 3 (Class 1)	60 - 90%*
ISO 1-2	80 - 100%*

**Note:** Actual average velocity and air changes required may vary depending on the application and floor plan.

\* ULPA filters required in Class 1/10 applications. HEPA filters required for all others.

**Table 1:**  
Recommended Air Velocity Rates

Class	Average Airflow Velocity	Air Changes Per Hour
ISO 14644-1 (Standard 209E)		
ISO 8 (Class 100,000)	0.005 - 0.041 m/sec (1 - 8 ft/min)	5 - 60
ISO 7 (Class 10,000)	0.051 - 0.076 m/sec (10 - 15 ft/min)	60 - 150
ISO 6 (Class 1,000)	0.127 - 0.203 m/sec (25 - 40 ft/min)	150 - 240
ISO 5 (Class 100)	0.203 - 0.406 m/sec (40 - 80 ft/min)	240 - 600
ISO 4 (Class 10)	0.254 - 0.457 m/sec (50 - 90 ft/min)	400 - 750
ISO 3 (Class 1)	0.305 - 0.457 m/sec (60 - 90 ft/min)	500 - 750
ISO 1-2	0.305 - 0.508 m/sec (60 - 100 ft/min)	500 - 750

**Note:** Actual average velocity and air changes required may vary depending on the application and floor plan.

# CONFIGURATION GUIDELINES

Use this overview to help you select the Terra Modular Cleanroom design for your application.



**QuickQuote Planner**  
quickly configures a system to your specifications: [www.TerraUniversal.com](http://www.TerraUniversal.com)

**USP <797> Compliant!**  
See page 26 for systems configured for sterile compounding

## ISO 4-8 Cleanrooms



### Hardwall Cleanrooms – page 6

- Holds positive or negative pressure
- Chemical- and static-safe panel materials
- ValuLine™ option available (page 15)



### Softwall Cleanrooms – page 12

- Economical dissipative vinyl strips and curtains
- No pressure control (may not meet ISO 4/5)
- ValuLine option available (page 15)



### EZ-UP Cleanroom– page 16

- Low cost, quick and easy to install
- External and internal frame designs
- Smooth, easy-clean internal surfaces

## ISO 4-8 Bio-Pharmaceutical Cleanrooms



### BioSafe® Cleanrooms: Plastic Panels – page 11

- FM-approved FRP or C-PVC panels
- Ideal for aseptic processes requiring sterilization
- Free-standing modular rooms or existing room conversion



### BioSafe Cleanrooms: Steel Panels – page 10

- Powder-coated or 304/316 stainless steel
- Radius corners for easy wipe-down, sterilization
- Configure for positive or negative pressure



### USP 797-compliant Compounding Cleanrooms – page 26

- ISO 8 Ante-room and ISO 7 Buffer room
- FM-approved FRP panels meet aseptic requirements
- Turnkey systems start under \$20,000

## Special Applications

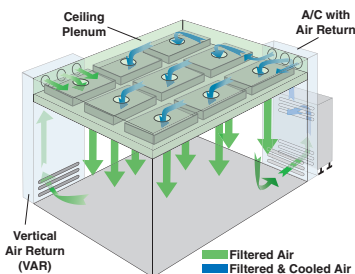

### Temperature/Humidity Control – page 24

- Air conditioning modules interface directly to cleanroom
- Humidification/de-humidification solution
- Complete range of monitoring equipment

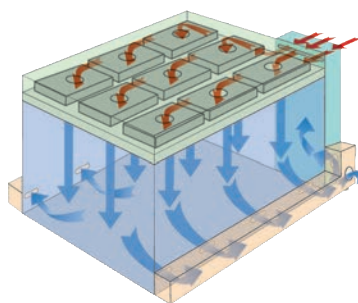

### Ventilation/Containment – page 25

- Safe removal of fumes, vapors, dust
- Floor-mount and ceiling-mount exhaust fans
- BSL 1 and BSL 2 containment

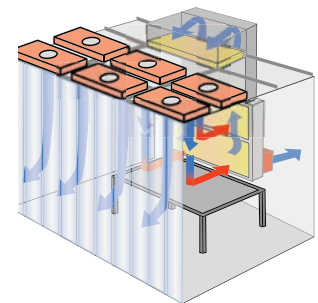

### Powder Containment Booth – page 17

- HEPA filtration/recirculation removes sub-micron particles
- Turnkey systems start under \$14,000

# HARDWALL CLEANROOMS

Terra's Hardwall Modular Cleanrooms provide the rigidity and durability of a freestanding room. All components are factory-assembled and tested before shipping, and Terra provides a number of installation options.

Unlike other modular cleanrooms on the market which require complex suspended ceiling supports, Terra cleanrooms are completely free-standing, steel-frame structures.



**IonBar™**—  
for a cleaner cleanroom  
Eliminates surface charges that attract particles.

**Operation Status Indicator verifies FFUs are running**



**Automated Monitor/Control**—  
View critical conditions (pressure, temperature, RH) on a centralized console. Fan control simplifies balancing and certification. See pg. 27.



*Any size or floor plan!*

## Ordering Information

Use the catalog numbers below to specify the cleanroom style for your application. Specified rooms include powder-coated steel frame, control panel, and wall panels of material specified. Select access door(s), ceiling modules and other accessories to complete your system.

Plastic Hardwall Cleanrooms				
Panel Material: (see description at right)	Acrylic*	Dissipative PVC	Polycarbonate	Polypropylene
	Cat. #	Cat. #	Cat. #	Cat. #
External Mount Panels	6600-00	6600-01	6600-02	6600-03
Internal Mount Panels	6600-05	6600-06	6600-07	6600-08

\* Acrylic is damaged by alcohol and other cleaning agents.

Recommended Fan/Filter Configurations (see pg. 20)							
Nominal Dimensions	No. of Ceiling Bays	No. of Filter Modules to meet Fed Std 209 ISO Standards					
		3	4	5	6	7	8
8' x 8'	8	5-8	4-8	3-6	2-3	1-2	1
8' x 12'	12	7-12	6-12	4-8	3-5	2-3	1-2
8' x 16'	16	10-16	8-16	6-11	4-6	2-4	1-3
12' x 12'	18	11-18	9-18	6-13	5-7	3-5	1-3
12' x 16'	24	14-24	12-24	8-17	6-10	4-6	2-4
16' x 16'	32	19-32	16-32	11-22	8-13	5-8	2-5
20' x 20'	50	30-50	25-50	18-35	13-20	8-13	3-8

### Select Panel Mounts For Your Requirement —

**Internal-Mount Panels**  
*Smooth internal surface is easy to disinfect.*

**External-Mount Panels**  
*Includes mirror-finish 304 stainless steel control panel and mounting strips for a showcase room that's also durable and easy to clean.*

### QuickQuote Planner

quickly configures a system to your specifications: [www.TerraUniversal.com](http://www.TerraUniversal.com)

### Cleanroom accessories begin on page 17

- Filter/Fan Units – HEPA/ULPA, low noise & vibration
- Lighting – fluorescent, teardrop, flow-through, UV
- Ionizing Modules – control ESD
- Air Conditioning and Dehumidification Modules
- Ceiling Ventilation Modules – for negative-pressure applications

### Other Modular Cleanroom Styles

- Softwall Plastic Cleanrooms – see page 12
- BioSafe® Cleanrooms – see page 10
- EZ-UP Cleanrooms – see page 16

**USP <797> compliant models for sterile compounding—pg. 26**



Fan Filter Units



### Cleanroom Support Frame

The support frame is fabricated of interlocking 1 3/4" powder-coated square steel uprights and cross sections. Ceiling members are welded to steel 3" x 1 1/2" T-bars, forming the 2' x 4' bays that support filters and lights. Vertical finishing strips, fabricated of mirror-finished 304 stainless steel, hold hardwall panels securely in place. Standard height is 7' measured from filter face to floor (8'3" with fan/filter unit), allowing installation beneath a standard 9' ceiling. Other heights are available.

### Hardwall Panels

Standard 4'W x 7'H panels are available in four rigid materials:

**Acrylic Panels** offer economy, visibility and strength. Black and amber panels are also available. Not recommended for use with alcohol or other strong cleaning agents. Difficult to clean since they tend to attract and retain particles.

**Static-Dissipative PVC Panels** safely remove surface charges, protecting against potentially damaging ESD (electrostatic discharge) as well as particulate attraction. Dissipative layers are molecularly embedded for optimal durability. Surface resistivity: 10<sup>6</sup>-10<sup>8</sup> ohms/sq. (ASTM-D257).

**Polycarbonate** resists many common acids, solvents and cleaning solutions.

**Polypropylene** provides superb resistance to acids and other chemicals (see photo on page 8).

*\*Acrylic is not recommended for use with alcohol and other cleaning agents.*

## Hardwall Options

### Access Doors

Select among swing and sliding door designs, with stainless steel or aluminum frames and tempered glass, dissipative PVC or acrylic panels. Specialty configurations include fast-response roll-up designs and touchplate-activated doors.

See page 8.



Swing door



Aluminum frame sliding door

### Fan/Filter Units (FFUs) and Lights

HEPA and ULPA filters meet cleanliness standards to Class 10 (ISO 3). Many configurations available, including carbon units, for chemical vapor removal, and UV sanitation modules to eliminate germs.

See pages 20 – 23.

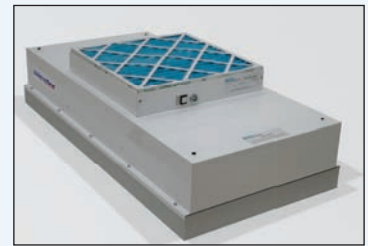

### Control Panel with Operation Status Indicators

Mounted to the right of the access door, this panel allows convenient control of fan/filter units (FFUs), lights, ionizing modules, and other system options. Its mirror-finish contributes to the showcase exterior of the cleanroom. It includes a Magnehelic® differential pressure gauge for easy monitoring of internal air pressure, and an Operation Status Indicator (OSI) in each corner, which provides a solid glow to indicate that FFUs are operating, and flashes to indicate they're not. One required per cleanroom.



Operation Status Indicators (OSIs) in each corner glow to indicate FFUs are in operation



### Night Service Switch

Energy-saving mode maintains round-the-clock cleanroom integrity at lower cost—paying for itself in most cases within a year. See page 23.

Panel with OSI	Standard Control Panel		Control Panel with Night Service Switch*	
Room Panel Type	Cat. #	S/Each	Cat. #	S/Each
External Mount	6600-23	1,621.00	6600-23-NS	1,779.00
Internal Mount	6600-24	1,621.00	6600-24-NS	1,779.00

\*Requires Night Service configuration charge/FFU; see page 23

### Partitions and Air Locks (Antechambers)

**Air Lock** serve as contamination buffer zones; as staging areas; or as gowning areas. **Partitions** create multiple clean zones to meet varying cleanliness requirements inside a single cleanroom. Call to specify configuration. **Note: Partitions and air locks must be specified when cleanroom is ordered.**



### Cleanroom Talk-Through

Ideal for cleanrooms, as well as laboratory and hospital isolation areas, the Talk-Through features a clean plastic frame and transparent mylar diaphragms that allow workers on both sides of a cleanroom wall to communicate freely.

Model shown	Cat. #	S/Each
	5050-50	377.00



## CLEANROOM ACCESS DOOR OPTIONS

Select among many door options to meet your clearance and cleanliness requirements, including rapid-response doors.

### A. Stainless Steel or Aluminum Swing Doors

Select models with tempered glass, acrylic or static-dissipative PVC panels. Dimensions: 36"W x 81"H (72"W double doors available).

### B. Aluminum-Frame Sliding Doors

These aluminum-frame doors slide open along an extruded aluminum track to an opening of 36". Requires two 4-foot cleanroom panel widths for installation. Standard model slides open from right to left; specify left-to-right slide, if desired. Dimensions: 40"W x 82"H.

Type (see photo)	Door Panel Material	Single Door	
		Cat. #	\$/Each
A*	Mirror-Finish 304 SS	Tempered Glass	<b>6602-00</b> <b>2,305.00</b>
A*	Mirror-Finish 304 SS	Static-Dissipative PVC	<b>6602-01</b> <b>2,183.00</b>
A*	Aluminum Swing	Acrylic**	<b>6710-14A</b> <b>985.00</b>
A*	Aluminum Swing	Static-Dissipative PVC	<b>6710-15A</b> <b>1,274.00</b>
B	Aluminum Slide	Acrylic**	<b>6704-02</b> <b>2,095.00</b>
B	Aluminum Slide	Static-Dissipative PVC	<b>6704-03</b> <b>2,310.00</b>

\* Standard swing is outward (away from cleanroom), mounted on right panel of shorter wall.

\*\* Acrylic is damaged by alcohol and other cleaning agents.

### C. Parting Strip Shields (see page 14)

Available in standard vinyl or anti-static vinyl, these 4"-W strip shields can be mounted in place of a standard door or 4-foot wide hardwall panel at any location along the perimeter of the cleanroom.

### D./E. High-Speed Doors

Roll-Up Door operates at up to 42 in/s, allowing transfer of large equipment with minimal impact on cleanroom. Feature non-porous, non-shedding, non-absorptive and non-permeable PVC-coated curtain. Operates under both positive and negative pressure.



	Cat. #	\$/Each
D. Roll-Up Door	<b>6710-53A</b>	<b>12,098.00</b>
E. Bi-Parting Door	<b>6710-54</b>	<b>17,444.00</b>

### F. – H. Automatic Doors and Air Showers

See facing page.



**F** Roll-up doors in three sizes—ideal for carts. Pricing and specifications at [TerraUniversal.com](http://TerraUniversal.com)



**G** Air Shower entry (see page 54), shown with BioSafe® Cleanroom

## BIOSAFE® WINDOWS

- Select frameless (shown at right) or framed designs, with single- or double-pane construction
- Designed for quick, easy installation in a variety of wall materials and thicknesses
- Frameless available in tempered glass; framed model also available in static-dissipative PVC, polycarbonate and acrylic
- Choose between standard sizes or specify custom dimensions to fit your requirements

Frameless design as stylish as it is clean



Unique design creates a 100% smooth showcase window that's easy to clean and install



BioSafe window with stainless steel frame. Full pricing and installation guide at [TerraUniversal.com](http://TerraUniversal.com)

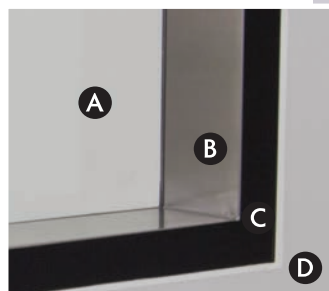

- Single- or double-paned tempered glass panes (fire-rated glass available)
- U-channel stainless steel frame provides a clean seal and features no visible hardware; internal mounting system installs against window supports in minutes, without special tools.
- Powder-coated black finish creates an attractive faux border that's part of the glass window, positioned on the inside surface so it can't scratch or degrade over time.
- Flush-mount design, either embedded in standard gypsum walls or (shown here) sealed to a cleanroom FRP panel using a two-part, FDA-approved seam treatment. Can also be surface mounted.



Versatile BioSafe panels accommodate complex cleanroom designs, with interior production rooms and gowning areas dedicated to your workflow and cleanliness requirements

## BIOSAFE® ALL-STEEL BIO-PHARMACEUTICAL CLEANROOMS

- Smooth surfaces and radius corners eliminate germ traps for easy cleaning and sterilization
- Pre-engineered, insulated panels provide thermal stability, dampen noise and vibrations, conceal wiring and gas lines
- Available in powder-coated or 304/316 stainless steel, with glass panels for full visibility of interior rooms
- HEPA/ULPA filtration modules meet cleanliness requirements to ISO 4 (Class 10)
- Several HVAC options available, including modular units that circulate air to a ceiling plenum chamber or to ductwork that feed individual fan/filter units (see page 20)
- Other options include pass-throughs, humidification/dehumidification, ionization, and UV sterilization

The unique BioSafe design supports aseptic operations. All panel materials—powder-coated steel, 304/316 stainless steel, and tempered safety glass—stand up to frequent cleaning with standard disinfectants, including DI water/alcohol solutions. Panel seams are caulked to eliminate cracks that could harbor germs and other contaminants. Radius bends on corner panels further facilitate cleaning by providing smooth surfaces that are easy to wipe down.



Complex Cleanrooms or Containment Labs with Modular Versatility and Economy — Ideal for Aseptic Processing!

### BioSafe Cleanrooms: Ordering Information

Use the catalog numbers below to specify the material for your application. A Terra application specialist works with you to develop the floor plan, panel heights and other configuration details you require. Standard 7'-high panels create a room that fits beneath a standard 9' ceiling. Select access door(s), ceiling modules and other standard Terra cleanroom modules to complete your system.

BioSafe		Cleanroom		Windows (specify quantity, size, location)	
Panel/Grid Material	Cat. #	Material	Cat. #		
Powder-Coated CR Steel	<b>6600-30</b>	Tempered Glass	<b>6600-45A</b>		
304 Stainless Steel	<b>6600-31</b>	Fire-Rated Glass	<b>6600-46A</b>		
316 Stainless Steel	<b>6600-32</b>	Static-Dissipative PVC	<b>6600-47A</b>		
		Polycarbonate	<b>6600-48A</b>		



Control Panel for BioSafe Cleanroom allows convenient control of Fan/Filter Units, lights and other system controls. Operation Status Indicators in each corner display FFU operation. One required per cleanroom.

Cat. # S/Each  
**6600-26 772.00**



*BioSafe Cleanroom shown with exterior drywall finish and fast-response automatic double doors.*

# BIOSAFE® PLASTIC MODULAR CLEANROOMS

- Modular design lets you tailor system components to your requirements for ISO 5-8 cleanliness
- Choose between FM-approved Fiberglass-Reinforced Plastic (FRP) or chlorinated PVC (C-PVC) panels
- All-steel support structure spans up to 20 feet without internal bracing
- Seam sealant provides a 100% sealed, smoothed interior that stands up to cleaning agents – ideal for aseptic bio-pharmaceutical applications.

Terra's BioSafe FRP and C-PVC Cleanrooms provide the ideal contamination-free processing environment for bio/pharmaceutical and other aseptic requirements.

Completely free-standing, these structures can be installed inside a warehouse or other unclassified spaces to create an ISO 5 – 8 cleanroom, typically without the need for costly, time-consuming permitting. Class A FRP and C-PVC panels bear the FM Approval for flame spread and smoke generation (per ASTM E-84); Class C FRP offers a lower-cost solution with identical cleanliness properties.

Two ceiling grid types are available for support of fan/filter units, light and ceiling panels: welded steel models provided exceptional strength, and BioSafe grids include precision-cut hold-down tabs for easy ceiling cleaning.

Accessories include multiple door styles (see page 8), fan/filter units (see page 20), pass-through chambers, A/C, LED and fluorescent lights, and tempered glass windows. Floors and corners can be covered for ease of cleaning. Call a Terra product specialist for a system that meets your floor plan and ISO cleanliness requirements!



### Coved Seams

White PVC coving can be installed along horizontal or vertical seams to provide easy-clean radius corners. Dimensions: 3.75" x 3.75" x 0.079" thick; radius: 1.625". Seam sealant is used to form a moisture-tight seal at all seams.

Cat. #  
**6601-61**



### Flush-Mount Tempered Glass Window

The 0.25"-thick tempered glass window is secured between two 304 stainless steel retaining frames, which feature no fasteners of other cleaning obstructions. Standard size: 47"W x 36"H (nominal); specify other desired sizes.

	Cat. #	S/Each
Tempered Glass	<b>6602-70A</b>	<b>1,531.00</b>
Fire-Rated Glass	<b>6602-71A</b>	<b>1,821.00</b>

### BioSafe Modular Cleanrooms: Specify grid type

Panel Type	Welded Ceiling Grid	BioSafe Ceiling Grid
	Cat. #	Cat. #
Class C FRP	<b>6601-80</b>	<b>6601-06</b>
Class A FRP	<b>6601-81</b>	<b>6601-07</b>
C-PVC	<b>6601-82</b>	<b>6601-08</b>



**APPROVED**  
Class A FRP and C-PVC panels are Factory Mutual approved

Specifications on pg. 18

# SOFTWALL CLEANROOMS

*Terra's Softwall Modular Cleanrooms provide an economical, versatile solution to clean manufacturing requirements in semiconductor, medical device, and many other industries. Portable, expandable, and easy to assemble/disassemble, these cleanrooms are also available on an accelerated delivery program to meet your tight production schedule!*

*Unlike other modular cleanrooms on the market which require complex suspended ceiling supports, Terra cleanrooms are completely free-standing structures.*

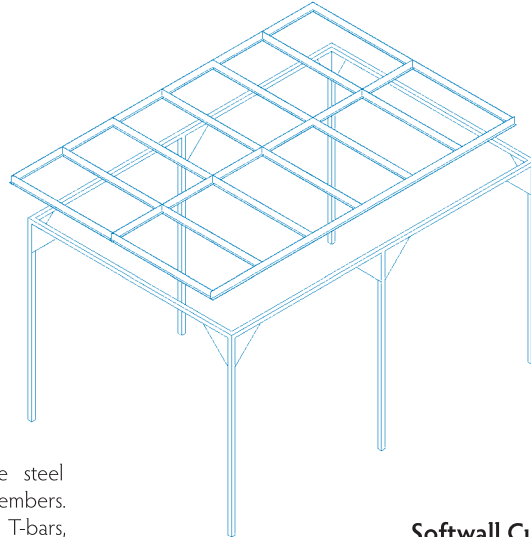

### Softwall Support Frame

The support frame is fabricated of interlocking 2½" powder-coated square steel uprights, cross sections, and ceiling members. Ceiling members are welded to steel T-bars, forming the 2' x 4' bays that support filters and lights. Corner reinforcement gussets ensure a rigid structure. Optional heavy-duty casters allow easy repositioning after installation. Standard height is 7' measured from filter face to floor (8' 3" overall), allowing installation below a standard 9' ceiling.

**Note:** Walls over 8' long require an additional vertical support member.

**Ask about Terra's ValuLine™ Cleanrooms—clean performance at lower cost!**

Operation Status Indicator verifies FFUs are running



### Softwall Curtains & Strip Shields

Softwall panels are fabricated of heavy-duty, blur-free 40-mil material—double the industry standard—ensuring enhanced tear resistance and eliminating the need for unsightly sewn sash weights. Strip shields, made of 40-mil material, come standard in 12" widths, with 2" overlap, for easy entrance or exiting. Polyurethane shields are 12"W, 40-mil thick.

Curtains and strips are available in three materials, in either clear or frosted appearance. See pg. 14 for ordering information.

## Ordering Information

Use the catalog numbers below to specify the cleanroom style for your application. Based on your desired floor plan, a Terra application specialist will quote you on a room configured for your application.

### Frame Kit

Includes a powder-coated steel frame of the dimensions you specify. Standard height is 7'; other heights available. Walls over 8' long require an additional vertical support member. Includes a control panel for operation of fan/filter units, lights, and other selected options.

	Cat. #
Powder-Coated Steel	<b>6600-60</b>
304 Stainless Steel	<b>6600-61</b>

### Recommended Fan/Filter Configurations

Nominal Dimensions	No. of Ceiling Bays	No. of Filter Modules to meet Fed Std 209 Class Standards					
		1	10	100	1,000	10,000	100,000
8' x 8'	8	5-8	4-8	3-6	2-3	1-2	1
8' x 12'	12	7-12	6-12	4-8	3-5	2-3	1-2
8' x 16'	16	10-16	8-16	6-11	4-6	2-4	1-3
12' x 12'	18	11-18	9-18	6-13	5-7	3-5	1-3
12' x 16'	24	14-24	12-24	8-17	6-10	4-6	2-4
16' x 16'	32	19-32	16-32	11-22	8-13	5-8	2-5
20' x 20'	50	30-50	25-50	18-35	13-20	8-13	3-8

## Softwall Curtains and Strip Shields

Order curtains and strip shields from page 14. Curtain material is 40-mil thick, clear PVC (anti-static PVC and polyurethane curtains also available). For access doors, select alternating clear and frosted strip shields, which eliminate cling for easy parting.

For 7'-high cleanroom, curtain length of 6'6" is recommended to allow adequate air exhausting. See formula on facing page for more information.



### QuickQuote Planner

quickly configures a system to your specifications:  
www.TerraUniversal.com

## Cleanroom accessories begin on page 17

- Fan/Filter Units – HEPA/ULPA, low noise & vibration
- Lighting – fluorescent, teardrop, flow-through, UV
- Ionizing Modules – control ESD
- Ceiling Ventilation Modules – for negative-pressure applications

## Other Modular Cleanroom Styles

- Hardwall Plastic Cleanrooms – see page 6
- BioSafe® All-Steel Cleanrooms – see page 10
- BioSafe® Powder-Containment Rooms – see page 17



To order curtains, see next page.

**Cleanroom-Grade Vinyl** is non-particulating and low outgassing.

**Static-Dissipative Vinyl** is manufactured with permanent built-in static inhibitors that will not wear off.

**Non-outgassing Panels** are made from inherently static-dissipative polyurethane that provides permanent, humidity-independent ESD protection for sensitive manufacturing conditions. Polyurethane contains no plasticizer, making it non-outgassing.

Softwall panels and strip shields attach to the support frame by means of a unique noncontaminating Grip-Track™ mounting system that eliminates cracks and seams where germs or particles can collect. Other mounting systems are available.

**Note:** Softwall curtains are notched to ensure a snug fit at all corners. In standard installations, curtains are supplied in lengths of four feet. Where two curtains meet, the curtain panels overlap by 6". To prevent personnel from parting curtains at these seams, order optional curtain seaming, Dual-Lock™, magnetic closures, or attachment clips at right. See following pages for more information.

### Strip Doors

Strip shields can be ordered in convenient widths to create access doors for softwall or hardwall cleanrooms. By alternating strips of clear vinyl with frosted vinyl, you eliminate both sticking and air gaps, creating entrances that are cleaner and easier to walk through.

**Note:** Strip doors are free-hanging—standard installations do not include attachment of the two sides to adjacent curtains or frame.



**IonBar™**—  
for a cleaner cleanroom

Eliminates surface charges that attract particles.

## Softwall Options

### Casters

Stainless steel swivel casters feature nonshedding polyurethane wheels. Capacity: 300 lbs. each. Order one per vertical post

Price includes installation.

	Cat. #	S/Each
6"-diameter locking caster (Raises cleanroom 7 3/16")	<b>6704-08</b>	<b>158.00</b>



### Dual-Lock Strips

For sealing curtains or strip shields to frame supports or overlap areas, Terra offers non-particulating, clear 3M Dual-Lock with plasticizer-resistant adhesive. These strips are ideal for application along the vertical frame uprights or along the vertical length of a curtain or strip, allowing corner or overlap attachment that minimizes air leaks. Price includes sewing of mating strips to specified curtains. Use quantity to specify desired number of feet.

	Cat. #	S/Linear ft.
Dual-Lock Strip	<b>6704-05</b>	<b>13.00</b>

### Flexible Magnet Strip Self-Closures

Flexible, chemical-resistant magnet strips are ideal for a variety of custom closure needs. Price includes sewing to specified curtain. Use quantity to specify desired number of feet.

	Cat. #	S/Linear ft.
Magnet Closure	<b>6704-06</b>	<b>16.00</b>

### Snap-Tite™ Clips

Ideal for securing two curtains together. Each two-piece plastic clip snaps together through holes in the curtains.

	Cat. #	S/Linear ft.
	<b>6704-07</b>	<b>2.00</b>

### Control Panel with Status Operation Indicators

Includes panel with FFU and light control, as well as one FFU status indicator at each corner (see photo).

	Cat. #	S/Each
Standard Panel	<b>6600-25</b>	<b>1,506.00</b>
Panel with Night Service Switch (see page 23)	<b>6600-25-NS</b>	<b>1,663.00</b>

### Adjustable Uprights

Allow up to 18" vertical height adjustment during installation. For rooms up to 8' x 8' only.

	S/Upright
8' Upright	<b>Call TUI</b>

### Selecting the proper panel length

All softwall cleanrooms require some gap between the curtain and the floor to allow air to escape. If this gap is too narrow to accommodate the flow of air generated by the ceiling fan filters, then curtains and strips will billow outward. If it is too big, the cleanroom will not maintain adequate positive pressure.

In general this formula helps you determine how long the curtains should be:

$$\text{Gap between curtain and floor} = \frac{\text{Total surface area of filters in ceiling grid}}{\text{Perimeter of cleanroom}}$$

For a 16' x 16' cleanroom with 7 ceiling filter fans, this gap should be about 10.5" (56 sq. ft. of filter ÷ 64 ft. (perimeter) = 0.875 ft. gap. This is exactly the gap produced when a 6' curtain is installed on a standard cleanroom frame, since the curtain bead is mounted about 1.5" below the filter face (6'10.5" above the floor). If the same cleanroom included casters, which raise the cleanroom about 7", then a 6'6" curtain would be appropriate.

Refer to curtain ordering chart on the following pages to select the curtain for your application. The plastic curtain material is easy to trim to the exact size you require.



- Grip-Track opens and closes without tools for easy panel mounting.
- Smooth profile in closed position won't harbor contaminants

# SOFTWALL CURTAINS and STRIP SHIELDS

- Suitable for all classes of cleanrooms and all levels of process isolation
- Available in static-dissipative PVC and nonoutgassing, static-safe polyurethane
- Standard one-piece Grip-Track™ mounting system is easy to clean, eliminates exterior crevices where contaminants can collect
- Heavy-gauge materials hang straight, without the need for sewn hems or cumbersome sash weights
- T-Grid Mounting System allows suspension of curtains or strip shields from existing cleanroom T-grids
- Industry-leading fabrication and mounting technology gives you the cleanest, most durable curtains and strip panels available
- Ideal for creating partitions inside a hardwall or softwall enclosure



These softwall curtains and strip shields are ideal for use with Terra's free-standing Softwall Cleanrooms on the previous pages. They can also be installed directly onto existing walls or ceilings using the versatile Grip-Track mounting system.

Either way, you receive the cleanest, most durable panels available. Standard softwall curtains are fabricated of heavy-duty, blur-free 40 mil material—double the industry standard—ensuring enhanced tear resistance and eliminating the need for unsightly sewn sash weights. Strip shields, made of 60-mil vinyl, come standard in 8" widths, with 2" overlap, to form parting doors or reach-throughs. Polyurethane shields are 40 mil x 12" W.

Select the panel material to meet your application requirements. Static-Dissipative PVC includes permanent built-in static inhibitors that, unlike topical treatments, will not wear off. Tests performed per ASTM D257 show surface resistivity of  $1.8 \times 10^{10}$  ohms/sq.

Terra also offers panels made from static-dissipative polyurethane that provides permanent, humidity-independent ESD protection from sensitive manufacturing conditions. This material contains no plasticizer, making it virtually non-outgassing.



Smooth profile in closed position won't harbor contaminants

## Grip-Track (standard)

Eliminates all cracks and crevices where dust and germs can collect. One-piece mounting track, made of rigid white polyethylene, incorporates flexible hinge and bottom flanges. Snaps open

and shut for quick, easy assembly. Compatible with T-Grid Mount for use with existing ceiling T-grids. Non-corrosive and easy to clean.

	Cat. #	S/Linear Ft.
Replacement Grip-Track	1322-60	8.00

## Suspended T-Grid Mount

Available for the Grip-Track, the T-Grid mount allows suspension of a curtain from standard T-grid ceiling without the need for ceiling disassembly. Perfect for partitioning a hardwall or softwall cleanroom into multiple clean zones, or for establishing temporary isolation areas!

	Cat. #	S/Linear Ft.
For 2" Ceiling Grid Supports	6704-23A	3.00
For 1.5" Ceiling Grid Supports	6704-24A	3.00

### Bi-Folding Curtain Mount

Available in anodized aluminum or stainless steel, this system allows softwall curtains to be easily retracted or extended along a heavy-duty, smooth rolling track. Contact Terra for ordering information.

- Dual-Lock Strips
- Magnetic Strip Self-Closures
- Snap-Tite™ Clips

## Ordering Guide

Pricing is per linear foot. Use quantity to indicate the length in feet of the curtain or strip panel (e.g., quantity 8 = an eight-foot run of material of the specified height). Grip-Track mounting is standard.



### Please note these construction details:

- Standard curtains come in 4-foot wide panels, which are mounted to create the run specified. Strip shields come in overlapping 8"-wide strips.
- Corners are notched to ensure a snug fit against frame corners.
- Adjacent panels overlap by 6", which generally provides an adequate air barrier.

Type	For Ceiling Height	Anti-Static Vinyl		Polyurethane (non-outgassing)	
		Cat. #	S/Linear Ft.	Cat. #	S/Linear Ft.
Curtain Panel (40 mil)	Up to 8 ft.	1320C-08	49.00	1320-30	127.00
	Up to 10 ft.	1320C-10	59.00	1320-34	143.00
Strip Shield (60 mil)	Up to 8 ft.	1320S-08	49.00	1320-67	154.00
	Up to 10 ft.	1320S-10	59.00	1320-71	175.00

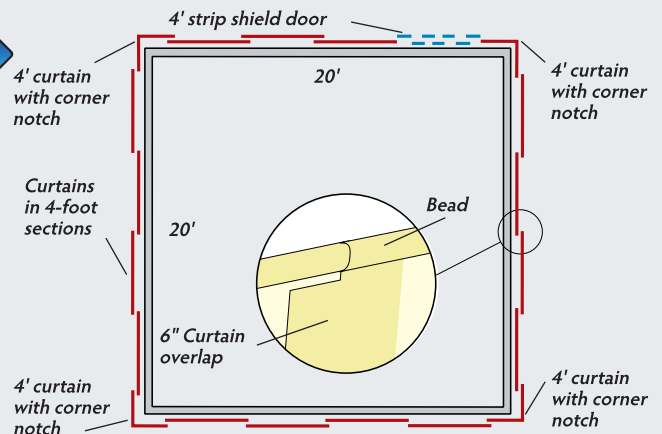

Typical configuration for a 76-foot run of panels, plus a 4-foot strip shield door

# VALULINE™ SOFTWALL & HARDWALL MODULAR CLEANROOM



**Value without compromise!**

Clean conditions—at lower cost.

All models ship within a week with only 3 - 4 day shipping on standard configurations!

- Create an economical cleanroom in nearly any office or production space in just a few days!
- The ideal environment for material testing, processing and packaging, as well as enclosing particle-sensitive equipment
- Ten standard sizes come preconfigured to meet particle cleanliness requirements from ISO 5 – ISO 8 (Class 100 – Class 100,000)
- All-steel support frame and ceiling grid creates a rigid, free-standing support structure
- HEPA Fan Filter Units (FFUs) provide up to 808 CFM (at high speed)
- Fluorescent Light Modules provide 9440 lumens each
- Power Supply Unit includes On/Off power switch, 120V power outlet, and cord - plugs into standard 20A wall circuit
- Pre-drilled, pre-kitted components for easy installation
- Select optional casters for easy positioning

Terra Universal's ValueLine Softwall and Hardwall Cleanrooms provide low-cost contamination control, creating an ISO 5 – ISO 8 environment nearly anywhere you need clean areas, and standard configurations ship in just 3 – 4 days.

Choose among ten standard sizes, each preconfigured to meet a specific cleanliness requirement. Entries can be positioned at any corner. Each model includes everything you need—even a tool kit—to get your system up and running in a few hours (two assemblers required). All electrical components, including Fan Filter Units, are UL listed.

ValuLine Softwall cleanrooms are configured for quick shipment, usually in one week. For other sizes or custom configurations, see page 12.

#### Construction:

Frame and Grid: Powder-coated steel: square tube uprights and frame

Panels and strip shields: Anti-static PVC panels and strips (softwall)  
Acrylic panels (hardwall)

Fan Filter Units: 2' x 4' HEPA, 3 speeds (see page 20)

Lighting: 2' x 4', 4-tube fluorescent fixture, 9440 lumens, 120 W, 120-277VAC

Power Supply Unit: Switched supply to six-receptacle unit for connection of up to 3 FFUs and lights, plus one non-switched 120V outlet, cord and 3-prong plug. Each plugs directly into a free 120VAC, 60Hz, 20A circuit (220V models available).

Ceiling Panels: Polypropylene

	Cat. #	S/Each
ValuLine Softwall Modular Cleanroom	<b>6600-66-VL</b>	<b>Call TUI</b>
ValuLine Hardwall Modular Cleanroom	<b>6600-21-VL</b>	<b>Call TUI</b>



#### Cleanroom Casters (softwall only)

Stainless steel swivel casters feature nonshedding polyurethane wheels. Capacity: 300 lbs. (136 kg.) each. Order one per vertical post. Price includes installation. Casters raise the frame 7.125" (181 mm). If casters are ordered with a cleanroom, the frame will be made shorter to keep the floor to filter face dimension to specification. Casters add one day to cleanroom lead time.



Cat. #	S/Each
<b>6704-08</b>	<b>158.00</b>

# EZ-UP CLEANROOM™ MODULAR ENCLOSURE



No. 6604-55 Internal frame EZ-UP Cleanroom, shown with optional Fan/Filter units, swing door and air conditioning module.

- Unique modular system combines low cost and fast delivery for a range of isolation and containment applications
- Easy-assemble units take hours, not days or weeks, to install
- Versatile frame configurations meet wide range of process requirements
- 40 mil fire-resistant, anti-static vinyl offers both cleanliness and durability
- Fan/Filter Units or versatile air handler provides HEPA-filtered air flow to create clean processing enclosure (meets particle requirements to ISO 7)

Terra's unique EZ-UP Cleanroom provides a low-cost alternative to conventional modular cleanrooms for situations that require rapid set-up, spacious access, clean performance, or contamination containment. This modular design is ideal for equipment enclosures, assembly and packaging operations, and other clean operations. With selection of HEPA fan/filter units or an air handling system, they meet cleanliness levels to ISO 7, making them ideal for a wide range of applications.

These versatile structures offer several design options to meet your process requirements:

**Internal Frame EZ-UP Cleanrooms** (shown) provide an internal powder-coated steel support frame, with zippered end pieces and an RF-welded vinyl enclosure.

**External Frame EZ-UP Cleanrooms** feature smooth internal surfaces that are easy to wipe down and sterilize.



## HANDHELD PARTICLE COUNTERS



### HPC300 3-Channel Particle Counter

Compact size and simple pushbutton controls make this economical counter ideal for environmental monitoring in tight spaces. Provides three selectable channels between 0.3 µm and 25 µm (default: 0.3 µm, 0.5 µm and 5.0 µm).

	Cat. #	S/Each
HPC300	1510-31	1,794.00

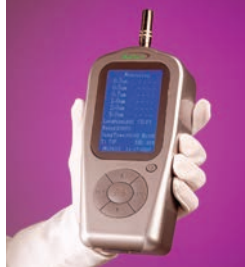

### HPC600 6-Channel Particle Counter

Provides the convenience of handheld operation and the printing and remote monitoring capabilities of a benchtop model. Internal memory stores up to 6000 measurements (1000 data sets). Provides six selectable channels continuously adjustable in 0.1 µm increments between 0.3 µm and 25 µm (default: 0.3, 0.5, 0.7, 1.0, 2.0 and 5.0 µm).

	Cat. #	S/Each
HPC600	1510-30	2,569.00

Internal-Frame EZ-Up Cleanroom™		
	Standard Height	Cat. #
Internal Frame: Sealed Panels (with pressure control; includes floor attachment bars)	8.5'	6604-55
Internal Frame: Softwall Panels (without pressure control)	9'	6604-56
External Frame: Smooth internal surfaces for easy cleaning	9'	6604-57

# BIOSAFE POWDER CONTAINMENT ROOM

The ideal enclosure for pharmaceutical handling —

- ✓ Purity testing
- ✓ Weighing
- ✓ Packaging
- ✓ Chemical analysis

- Recirculation module creates a HEPA-filtered clean zone
- Rear-mounted air vents draw air and powders away from operator and work area
- Rear manifold recirculates air through HEPA filters for a continuous wash of particle-free air to the work area

Terra's Powder Containment Room captures powders generated during packaging and weighing processes, while providing a contamination-free working space.

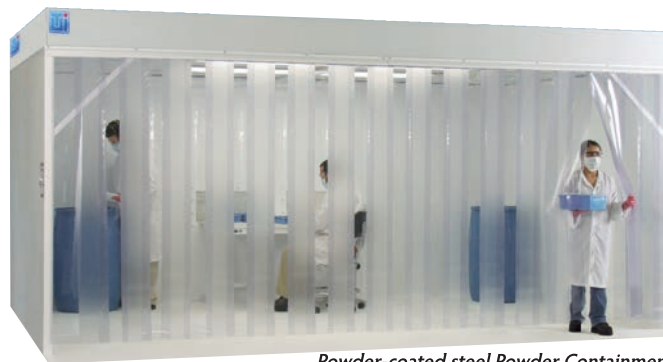

Powder-coated steel Powder Containment Room equipped with full-width strip shields

## Powder Containment Booth

Powder-Coated Steel  
304 Stainless Steel  
316 Stainless Steel

Cat. #  
**6600-75**  
**6600-76**  
**6600-77**

## CleanZone Recirculation System

Includes exhaust filter housing, ductwork, and FFU adapter collar, and adjustable fresh air damper. Order outlet filters (2) and FFU separately.

Cat. # \$/Each  
**6600-84** **1,897.00**

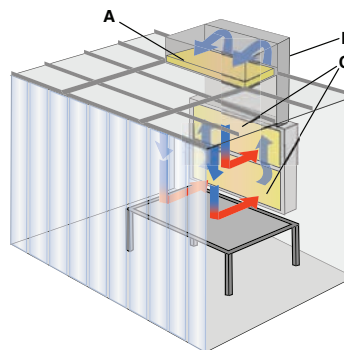

- A\* 99.99% efficient HEPA filter/fan unit
- B\* Return duct directs air flow away from operator
- C\* Exit HEPA filters

- ➔ HEPA-Filtered Air
- ➔ Contaminated Air

*Exhaust-only module also available at [TerraUniversal.com](http://TerraUniversal.com)*

## Neutral Pressure Room: Protects Outside Lab

CleanZone Recirculation System creates a HEPA-filtered clean zone that captures hazardous powders, protecting the external environment.

# CLEANROOM DEHUMIDIFICATION MODULES

- Extends shelf life of pharmaceuticals, semiconductor components, food products, and other sensitive materials
- Provides the humidity stability required by FDA and other regulating agencies
- Regenerating silica gel desiccant system produces dry air flow between 50 and 300 CFM

These low-maintenance systems feature silica gel desiccant housed in a rotor. Moisture in the process air passing through the rotor is adsorbed, producing a flow of dry air. Concurrently, reactivation air is heated and passed through the rotor to regenerate the silica gel and ensure continuous operation. The humid regeneration air is then ducted outside the cleanroom.

Adsorption Rate	No. 6710-60	No. 6710-61	No. 6710-62
70°F @ 50% RH	1.1 lbs./hr.	3.3 lbs./hr.	6.6 lbs./hr.
70°F @ 30% RH	0.8 lbs./hr.	2.5 lbs./hr.	5.0 lbs./hr.
70°F @ 10% RH	0.3 lbs./hr.	0.9 lbs./hr.	1.8 lbs./hr.



### Cleanroom Dehumidification Modules (240/3/60 and 480/3/60 voltages also available)

Dimensions (W x D x H, inches)	Process Air Flow	Reactivation Air Flow	Weight	Full Load Amps	Reactivation Heat	Power Consumption	Voltage	Cat. #	\$/Each
29.75 x 15.25 x 22	50 CFM	15 CFM	85 lbs.	12	3,240 BTUH	1,400 Watts	120/1/60	<b>6710-60</b>	<b>4,549.00</b>
36.375 x 24.5 x 27.25	150 CFM	45 CFM	190 lbs.	18	9,725 BTUH	3,850 Watts	240/1/60	<b>6710-61</b>	<b>5,000.00</b>
44.5 x 33.25 x 32.25	300 CFM	90 CFM	300 lbs.	32.9	19,448 BTUH	6,900 Watts	240/1/60	<b>6710-62</b>	<b>7,727.00</b>

## LIGHTING AND OTHER ACCESSORIES

- Visit [TerraUniversal.com](http://TerraUniversal.com)

- Humidifiers
  - Static Neutralizers
  - Air Velocity and Humidity Monitors
  - Fire Detection & Suppression
  - Vacuum/Gas/Power Receptacles
- Fan/Filer Units – see page 20**

Convert unclassified office space . . .

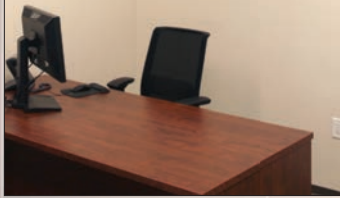

. . . into an ISO 5 – 8 cleanroom!



## BIOSAFE® CLEANROOM CONVERSION SYSTEM

- Convert a standard office into an ISO 5-8 cleanroom in a fraction of the time, and at a fraction of the cost, associated with new construction
- Ideal for universities, government laboratories and other facilities where new construction or a modular structure is unfeasible
- Unique system includes modular ceiling grid, BioSafe Cleanroom Wall System (FRP or C-PVC panels), and a variety of access and flooring options
- Rigid all-steel grid design accommodates spans up to 20 feet without internal support columns or ceiling suspension wires, even when fully loaded with HEPA filter/fan units and lights
- Accessories include corner coving, room-side replaceable HEPA fan/filter units (FFUs), lights, windows, control systems, and pass-through ports
- Complete installation services include seismic load analysis, HVAC integration, and coordination with your contractor

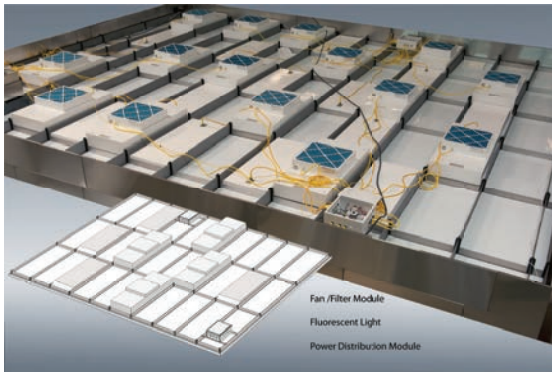

Powder-coated steel grid supports standard 24" x 48" fan/filter units, lights, or ceiling panels

### System Components

**Ceiling Grids:** Rigid, all-steel interlocking and self-supporting meets ISO 5 – 8 requirements. Mounts directly to existing wall or rest on top of walls with no ceiling. Extends up to 20 feet without the need for internal support columns or ceiling suspension wires.

**Cleanroom Wall System:** Made of FRP or C-PVC. Mounts to any wall type (also accommodates USP-797 Compounding Cleanrooms) See details on page 11.

**Room-Side Replaceable Fan/Filter Unit:** Available with HEPA and ULPA filters.

**Cleanroom Lighting:** Available in LED strips or fluorescent ceiling modules.

**Pass-Throughs and Air Showers:** Reduces cross contamination.

**Cleanroom Doors:** Available in Aluminum Frame Swing Door, Aluminum Frame Sliding Door and Stainless Steel Swing Doors.

**Service Outlets:** For installation of electrical and vacuum/gas utility outlets.

**Terra** provides complete pre-sale and after-sale support. Call Terra for complete quotations including drawings (if applicable) and manufacturing time.



BioSafe interior FRP panels: Class A FM-approved fiberglass-reinforced plastic (FRP) panels provide a 100% sealed, fire-rated, ISO 5-compatible enclosure

Class A FRP and C-PVC panels are Factory Mutual (FM) approved.





No. 6601-90, \$16,938  
20' x 10' x 10'H with swing door,  
acrylic panels, three lights



No. 6602-92, \$18,272  
20' x 10' x 10'H acrylic with polypropylene  
modesty panels, swing door, three lights

## MODULAR OFFICES

- Convert any office or production space into a clean environment!
- Acrylic or dissipative PVC wall panels allow full visibility (ceiling to floor or with opaque modesty panels)
- Modular power system allows addition of fan/filter units to meet cleanliness standards (ISO 4 – 8)

Terra's modular cleanroom design allows fast, economical installation of clean office space anywhere in your facility. Select hardwall (shown above) or softwall designs, in height up to 12 feet (floor to ceiling). Terra provides freestanding rooms or structures that bolt to an existing wall; call to discuss your requirement. What could be more convenient—a room you install in hours and plug into a single 120VAC power outlet!



ISO 7 enclosure for Thermal  
Vacuum Chamber (Ref. No. 169906)



ISO 7 enclosure for Anechoic  
Chamber (Ref. No. 169906)



ISO 6 enclosure  
for automated  
transfer conveyor  
(Ref. No. 178113)



ISO 6 4.5' x 36'D x 7'H static-dissipative PVC  
enclosure for automated transfer conveyor,  
showing conveyor access/maintenance ports  
(Ref. No. 178113, \$27,353)

## CLEANROOM EQUIPMENT ENCLOSURES

- Hardwall or softwall designs (ISO 4 to ISO 8)
- Special cut-outs and access doors accommodate power lines, entry/exit ports, interface modules

Terra modifies standard frame and ceiling designs to meet your custom requirements, including special interface ports, process conveyors, power or other facility pass-throughs, and unique ceiling configurations. Call to discuss your application!

# WHISPERFLOW FAN/FILTER UNITS (FFUS)

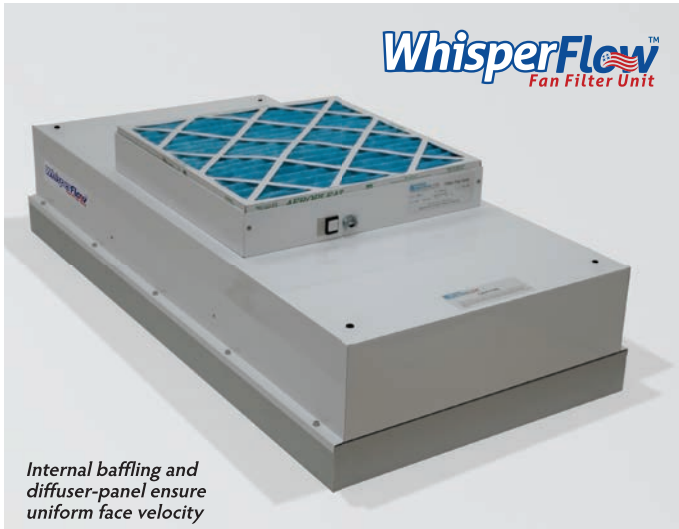

Internal baffling and diffuser-panel ensure uniform face velocity

- Low-profile design allows installation inside cleanrooms with standard 9-foot ceilings
- Quiet, low-vibration design: only 50 dBA, measured 30" from filter face @ 90 FPM
- Provides an average airflow velocity of 90+ feet per minute (.45+ m/sec) and airflow of 640+ CFM under filter load at medium speed (2' x 4' model)
- Three-speed switch simplifies air balancing
- Meets IEST Recommended Practices



These reliable, self-powered Fan/Filter Units provide a uniform flow of microfiltered air to meet cleanliness standards down to Class 10 (ISO 4).

All models use a 3-speed, centrifugal-type fan/motor with permanently lubricated bearings mounted inside a white powder-coated steel housing with drop-in prefilter (stainless steel available)

Advanced baffling technology ensures uniform airflow across the filter face and attenuates sound. Select HEPA (High-Efficiency Particulate Air) filters, rated 99.99% efficient at removing particle ≥ 0.3 microns, or ULPA (Ultra-Low Penetration Air) filters, rated 99.999% efficient at removing particles ≥ 0.12 microns. Provides years of no-maintenance, 24/7 operation, depending on your air quality.

All prices below include installation on a specified Terra modular cleanroom.

**Filter Fan Units (HS: high speed; MS: medium speed; LS: low speed)**

Model	Dimensions Inches (mm)	Wt. Lbs. (Kg)	Avg. CFM* m³/hr	Airflow ft/min (m/s)			Run Amps Watts @ 60Hz			Power	With HEPA Filter		With ULPA Filter	
				HS	MS	LS	HS	MS	LS		Cat. #	\$/Each	Cat. #	\$/Each
2' x 4'	23.63 x 47.63 x 12.51 (600 x 1210 x 318)	71 (32)	717 (1218)	115	102	93	4.3A	3.5A	3.3A	120VAC, 60 Hz	<b>6601-24-H</b>	<b>777.00</b>	<b>6601-24-U</b>	<b>877.00</b>
				(.58)	(.51)	(.47)	(512W)	(416W)	(393W)	220VAC, 50/60 Hz	<b>6601-24-H-220</b>	<b>887.00</b>	<b>6601-24-U-220</b>	<b>998.00</b>
2' x 3'	23.63 x 35.63 x 12.51 (600 x 905 x 318)	53 (24)	602 (1023)	121	116	106	4.1A	3.1A	2.7A	120VAC, 60 Hz	<b>6601-23-H</b>	<b>777.00</b>	<b>6601-23-U</b>	<b>887.00</b>
				(.61)	(.59)	(.54)	(500W)	(378W)	(329W)	220VAC, 50/60 Hz	<b>6601-23-H-220</b>	<b>887.00</b>	<b>6601-23-U-220</b>	<b>998.00</b>
2' x 2'	23.63 x 23.63 x 12.51 (600 x 600 x 318)	44 (20)	558 (948)	172	166	162	3.9W	2.8A	2.4A	120VAC, 60 Hz	<b>6601-22-H</b>	<b>777.00</b>	<b>6601-22-U</b>	<b>887.00</b>
				(.87)	(.84)	(.82)	(472W)	(339W)	(290W)	220VAC, 50/60 Hz	<b>6601-22-H-220</b>	<b>887.00</b>	<b>6601-22-U-220</b>	<b>998.00</b>

\* At medium speed



**Stainless Steel  
WhisperFlow™ Fan/Filter  
Units**

Features a 304 stainless steel housing, filter frame, and protective grille to meet rigorous cleanliness and chemical compatibility requirements.

**304 Stainless Steel Fan/Filter Units 120VAC/60 (220VAC available)**

Model	Nominal Dimensions Inches	With HEPA Filter		With ULPA Filter	
		Cat. #	\$/Each	Cat. #	\$/Each
2' x 4'	23.63 x 47.63 x 13	<b>6601-24-HSS</b>	<b>1,453.00</b>	<b>6601-24-USS</b>	<b>1,432.00</b>
2' x 3'	23.63 x 35.63 x 13	<b>6601-23-HSS</b>	<b>1,453.00</b>	<b>6601-23-USS</b>	<b>1,432.00</b>
2' x 2'	23.63 x 23.63 x 13	<b>6601-22-HSS</b>	<b>1,453.00</b>	<b>6601-22-USS</b>	<b>1,432.00</b>

## DID YOU KNOW?

**Fan/Filter Units Do More Than Meet ISO Requirements—they also prevent infection.**

Most cleanroom professionals understand that FFUs capture contaminants that degrade particle-sensitive samples. But they also remove bacteria and many viruses and mold spores that contribute to a host of infections.

Most common bacteria are contained by the 0.3-micron pore size of high-efficiency particulate air (HEPA) filters. Ultra-Low Penetration Air (ULPA) filters, which are rated 99.999% efficient at retaining particles of 0.12 microns and larger in diameter, capture ultra-fine contaminants, including many large viruses and mold spores.

These filters also remove aerosol-born pathogens – germs that literally hitch a ride on larger particles and liquid droplets that are captured in a HEPA or ULPA filter.



HEPA- or ULPA-based Fan/Filter Units (FFUs) thus can play an important role in infection prevention in surgical theaters, ICUs and other medical settings. Here is a list of common human pathogens that HEPA/ULPA filters capture and remove from circulation:

**Pathogens: Bacteria**

- Escherichia coli*
- Bacillus anthracis*
- Aspergillus brasiliensis*
- Francisella tularensis*
- Bordetella pertusis*
- Mycoplasma pneumoniae*
- Chlamydia pneumoniae*
- Clamydya psittaci*
- Klebsiella pneumoniae*
- Haemophilus influenzae*
- Coxiella burnetii*
- Pseudomonas aeruginosa*
- Actinomyces israelii*
- Legionella pneumophila*
- Thermoactinomyces sacchari*
- Alkaligenes*
- Streptococcus pyogenes*
- Mycobacterium Tuberculosis*

**Disease**

- Gastrointestinal infection
- Anthrax
- Sinus infections
- Tularemia
- Whooping cough
- Pneumonia
- Bronchitis
- Psittacosis
- Opportunistic infections
- Meningitis
- Q fever
- Opportunistic infections
- Actinomycosis
- Legionaire's disease
- Farmer's lung
- Opportunistic infections
- Scarlet fever
- Tuberculosis

# APPLICATION-SPECIFIC FAN/FILTER UNITS

## Room-Side Replaceable FFUs

Available with both HEPA and ULPA filters, Room-Side Replaceable (RSR) models allow filter replacement from the inside of the cleanroom. Because it eliminates the need for roof access or breaching the cleanroom, an RSR model greatly reduces maintenance time and costs. To service the filter, you simply rotate retaining clamps and lower the gel-sealed filter unit away from the fan module, which remains in place in the ceiling grid structure. The new filter seals against the "knife" edge of the fan housing. Models below are 120VAC/60Hz; 220VAC available.



Gel channel that seals against "knife" edge on fan housing.



RSR Fan Filter Units	Powder-Coated Steel Housing				Stainless Steel Housing			
	With HEPA Filter		With ULPA Filter		With HEPA Filter		With ULPA Filter	
	Cat. #	\$/Each	Cat. #	\$/Each	Cat. #	\$/Each	Cat. #	\$/Each
2' x 4'	6601-24-HR	1,092.00	6601-24-UR	1,202.00	6601-24-HRS	1,512.00	6601-24-URS	1,545.00
2' x 3'	6601-23-HR	1,092.00	6601-23-UR	1,202.00	6601-23-HRS	1,512.00	6601-23-URS	1,545.00
2' x 2'	6601-22-HR	1,092.00	6601-22-UR	1,202.00	6601-22-HRS	1,512.00	6601-22-URS	1,545.00

## Explosion-Proof FFUs

UL-listed for Class I or Class II, Division 1 locations as specified by the NEC. The direct-drive, 0.25 HP fan-cooled, non-sparking motor is designed for continuous-duty operation. Selection of this unit includes installation of filled rigid conduit and wiring. Housing is 304 stainless steel. Models shown below are 120VAC/60Hz; 220 VAC available.

Explosion-Proof FFUs	With HEPA Filter		With ULPA Filter	
	Cat. #	\$/Each	Cat. #	\$/Each
2' x 4'	6601-24-HE	3,263.00	6601-24-UE	3,379.00
2' x 3'	6601-23-HE	3,263.00	6601-23-UE	3,379.00
2' x 2'	6601-22-HE	3,263.00	6601-22-UE	3,379.00



## FFU Vapor-Removal Adapter

### Photo-Catalytic Oxidation (PCO) System Removes Chemical Vapor

This filtration system provides triple cleaning: UV lights kill bacteria, viruses and mold; a Photo-Catalytic Oxidation (PCO) panel removes organic vapors; and the FFU removes sub-micron particles. An activated charcoal pre-filter enhances vapor removal.

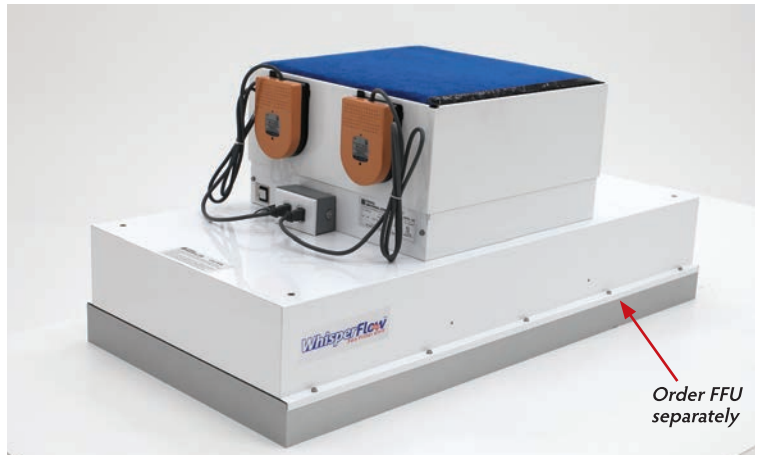
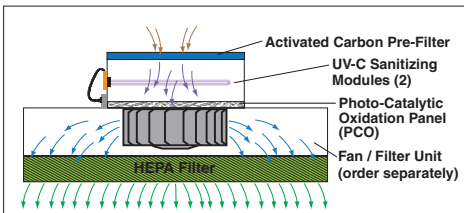

	Cat. #	\$/Each
WhisperFlow™ FFU Adapter Housing	6602-30A	481.00
PCO Panel	6602-36	595.00
Charcoal Pre-Filter	6602-35A	158.00
UV Sanitizing Module*	6602-40	130.00

\* Two required

# APPLICATION-SPECIFIC FAN/FILTER UNITS



## Low-Energy EC Fan Filter Units

These Fan Filter Units incorporate electronically commutated (EC) motors, a proprietary baffling system and backward-inclined fans to reduce lifetime cost of ownership and increase operational performance. Using a smart control system, these consume only 95 watts @90 FPM – greatly reducing cleanroom operating costs. They can help earn LEED (Leadership and Energy and Environmental Design) points, further reducing operating cost. They generate less heat and noise than AC FFUs, and they provide a much wider flow range, making them ideal for applications involving high static pressure. Models below are 120VAC/60Hz; 220VAC available.



Low-Energy EC FFUs	With HEPA Filter		With ULPA Filter	
	Cat. #	\$/Each	Cat. #	\$/Each
2' x 4'	6601-24-H-EC	1,245.00	6601-24-U-EC	1,365.00
2' x 3'	6601-23-H-EC	1,250.00	6601-23-U-EC	1,300.00
2' x 2'	6601-22-H-EC	1,190.00	6601-22-U-EC	1,300.00



## Exhaust Fan/Filter Units

### Remove Microcontaminants Generated Inside a Cleanroom

These reverse-flow fan filter units are ideal for rooms where powders, aerosols or fine dust is generated. The exit HEPA filter safely removes micro-contaminants down to 0.3µm from the air exhausted from the cleanroom. The perfect way to contain a potential environmental contaminant! More Ventilation Solutions—see page 23. Models below are 120VAC/60Hz; 220VAC available.



Exhaust FFUs	With HEPA Filter		With ULPA Filter	
	Cat. #	\$/Each	Cat. #	\$/Each
2' x 4'	6601-24-HV	1,147.00	6601-24-UV	1,202.00
2' x 3'	6601-23-HV	1,092.00	6601-23-UV	1,202.00
2' x 2'	6601-22-HV	1,092.00	6601-22-UV	1,202.00

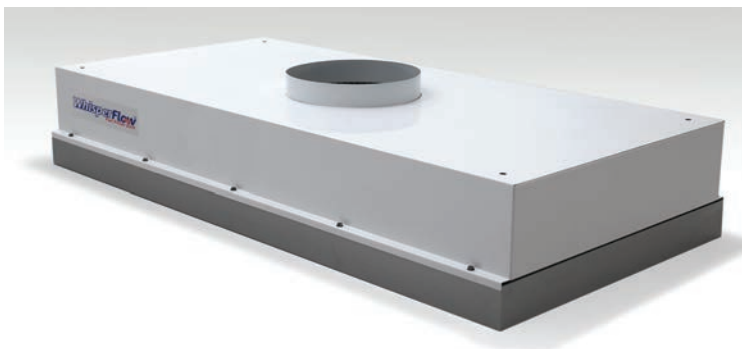

## Ducted Filter Modules

### HEPA/ULPA Modules Allow Easy Attachment to In-House Ventilation System

These filter modules include a 12" x 2"H collar for attachment to an air handler or other air source, which determines flow rate. Internal baffling system and diffuser plate ensure uniform face velocity. Additional models available for room-side filter replacement or remote damper adjustment; see TerraUniversal.com.



Nominal W x D	Standard Model				Room-Side Replaceable			
	With HEPA Filter		With ULPA Filter		With HEPA Filter		With ULPA Filter	
	Cat. #	\$/Each	Cat. #	\$/Each	Cat. #	\$/Each	Cat. #	\$/Each
2' x 4'	6601-24-HD	399.00	6601-24-UD	504.00	6601-24-HDR	798.00	6601-24-UDR	893.00
2' x 3'	6601-23-HD	399.00	6601-23-UD	504.00	6601-23-HDR	798.00	6601-23-UDR	893.00
2' x 2'	6601-22-HD	419.00	6601-22-UD	504.00	6601-22-HDR	798.00	6601-22-UDR	893.00

## Night Service Switch — Why Pay More for Less?

Terra cleanrooms are designed to meet a specified ISO cleanliness rating when a cleanroom is in use: with operations in progress, process machinery humming, and personnel in motion. So why pay to maintain that level of FFU performance when a production shift ends and people, the greatest source of contamination, leave the room?

With a greatly reduced contaminant load, a cleanroom at rest maintains its target ISO cleanliness standard with much less airflow, fewer air changes—and decreased power consumption. Terra's Night Service Switch provides this cleanliness at a nominal cost, giving you immediate cost savings.

Simply select the "Night Service" Switch when you turn off the lights and go home. A separate operation circuit drops all Fan/Filter Units (FFUs) into low-energy operation mode, shaving 25% of energy costs off your power bill while maintaining uninterrupted cleanroom performance at your specified cleanliness level. With Terra's Night Service Switch, operators can save up to 7,000 kilowatt-hours per year with a return on investment in slightly over a year.

# APPLICATION-SPECIFIC FAN/FILTER UNITS

## ValuLine MERV-16 FFU

These reliable units provide a uniform flow of micro-filtered air. Common applications for Minimum-Efficiency Reporting Value (MERV)-16 filters include HVACs in healthcare and medical facilities, along with other industrial/commercial buildings. All models use a powder-coated steel housing (304 stainless steel available).

MERV filters refine the air with lower operating costs as compared to HEPA or ULPA filters since they are less dense: lower energy consumption is required to force air through the filter material. The MERV-16 filter, the highest-performing of the MERV ratings, traps most bacteria, dust, moisture, and smoke.



MERV 16	Nominal Dimensions Inches	Power (220V models available)	Cat. #	\$/Each
2' x 4'	23.63 x 47.63 x 13	120VAC, 60 Hz	<b>6601-24-MERV</b>	<b>719.00</b>
2' x 3'	23.63 x 35.63 x 13	120VAC, 60 Hz	<b>6601-23-MERV</b>	<b>719.00</b>
2' x 2'	23.63 x 23.63 x 13	120VAC, 60 Hz	<b>6601-22-MERV</b>	<b>719.00</b>

## WhisperFlow™ Narrow FFUs

Like the models on page 20, these units provide highly uniform face velocity and reliability with low noise and vibration. Their narrower housing—at 16" rather than the standard 24"—makes them ideal for a wide range of narrow-profile hoods, cabinets, and other HEPA-filtered enclosures. Standard housing is powder-coated steel; 304 stainless steel available.



*Sixteen-inch-deep HEPA fan/filter unit fits into space-saving enclosures.*



## Powder-Coated CR Steel Fan / Filter Units with HEPA Filter

Model Width	Dimensions* W x D x H Inches	Wt. Lbs.	Avg. CFM** @ MS (m <sup>3</sup> /h)	Airflow ft/min			Run Amps (Watts) @ 60Hz			Power	With HEPA Filter	
				HS	MS	LS	HS	MS	LS		Cat. #	\$/Each
4'	48 x 16 x 13	50	685	172	152	148	4.1A	3.1A	2.1A	120VAC, 60 Hz 220VAC, 60 Hz	<b>6601-1624-H</b>	<b>777.00</b>
											<b>6601-1624-H-220</b>	<b>777.00</b>
3'	36 x 16 x 13	42	424	130	123	111	4.1A	3.1A	2.1A	120VAC, 60 Hz 220VAC, 60 Hz	<b>6601-1636-H</b>	<b>777.00</b>
											<b>6601-1636-H-220</b>	<b>777.00</b>
2'	24 x 16 x 13	34	340	153	149	127	4.1A	3.1A	2.1A	120VAC, 60 Hz 220VAC, 60 Hz	<b>6601-1648-H</b>	<b>777.00</b>
											<b>6601-1648-H-220</b>	<b>777.00</b>

\* With pre-filter installed. Nominal height of CE-marked units is 13.5" (343mm).

\*\* Average CFM at medium speed.

## Comparative Specifications:

2' x 4' (600 x 1210 mm) Terra Fan/Filter Unit No. 6601-24-H, operating at High, Medium, and Night Service setting			
Operation Setting:	High Speed*	Medium Speed*	<b>Night Service</b>
Airflow: cfm (m <sup>3</sup> /hr)	808 (1373)	717 (1218)	<b>654 CFM (1111)</b>
Air Speed: ft/m (m/s)	115 (.58)	102 (.51)	<b>93 ft/min (.47)</b>
Run Amps (Watts):	4.3 (512)	3.5 (416)	<b>3.3A (393W)*</b>

\* 25% savings over operation on high speed

\*\* Based off of an average-sized cleanroom with 10 FFU's, active cleanroom usage of 8 hours per day, and the U.S. Energy Information Administration's given average retail price of electricity at 10.72 cents per kilowatt-hour.

## Night Service Switch

Requires appropriate cleanroom control panel. (Price is per FFU.)

Cat. #  
**6601-70**      \$/Each  
**105.00**

# CLEANROOM AIR CONDITIONING



A/C Module mounted to return plenum, with cooled air ducted to fan/filter unit.

- Modular HVAC units ensure comfort and productivity of garbed cleanroom personnel
- External air baffles allow quick, easy control over ratio of recirculated/ make-up air
- Models available with humidity control maintain sub-ambient RH levels
- All units include Vertical Air Return that directs cooled air to ceiling FFUs via either a ceiling plenum or flexible ducts

These modular units remove heat to keep working conditions inside a modular cleanroom cool and dry.

Each HVAC unit is mounted to a Vertical Air Return (VAR), which includes a plenum chamber mounted to the side of the cleanroom. This structure (polypropylene or steel, depending on room design) draws air from the cleanroom into the HVAC module and then directs cooled air upward to the cleanroom ceiling, where it enters either a ceiling plenum or duct manifold (see illustrations below). On BioSafe Cleanrooms, return air is directed to the HVAC unit via ducts inside the BioSafe® panels. An adjustable baffle mounted outside the cleanroom lets you adjust the percentage of fresh make-up air.

A Terra application engineer will help select the HVAC module(s) appropriate to your cleanroom, based on room size, number of FFUs, and heat load. Typically, supplemental Vertical Air Returns are required to recirculate a portion of the cooled cleanroom air through ceiling FFUs. Select FFU Connect Packs to connect return ducts to individual FFUs.

**A/C Modules:**  
Includes air distribution plenum. All models operate on 220VAC, 50/60Hz.

Cooling Net BTUH	Dimensions (W" x D" x H")	AC Control Only		AC and RH Control	
		Cat. #	\$/Each	Cat. #	\$/Each
18,000	33.3 x 17.1 x 70.5	<b>6704-27</b>	<b>4,162.00</b>	–	–
48,000	42 x 22.5 x 85	<b>6704-28</b>	<b>5,607.00</b>	<b>6704-31</b>	<b>8,761.00</b>
57,000	42 x 22.5 x 85	<b>6704-29</b>	<b>7,802.00</b>	<b>6704-32</b>	<b>10,367.00</b>

UV sterilization available for return ducts.

**Vertical Air Return (each services up to 3 FFUs)**

	Cat. #	\$/Each
For Cleanrooms with up to 7' ceilings	<b>6601-10-HC-HE</b>	<b>2,216.00</b>
For Cleanrooms with ceilings over 7'	<b>6601-11-HC-HE</b>	<b>2,772.00</b>

Larger cleanrooms may require specially permitted, externally installed HVAC units to allow outside discharge of warm air. Call to discuss your application.

## HVAC Air Return Configurations

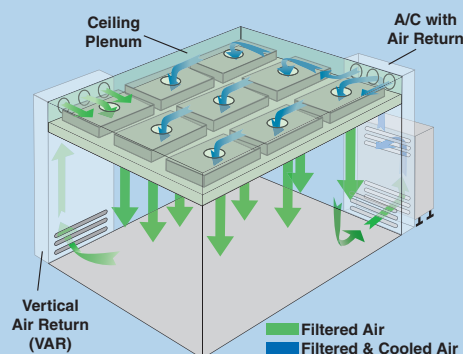

Cleanroom with ceiling plenum, HVAC module and Vertical Air Return

### Ductless Applications:

Air Conditioning with a Ceiling Plenum

In very large modular facilities, Terra recommends an insulated ceiling plenum, which provides cooled return air to the fan/filter units.

Air conditioning modules are mounted to air returns, which direct cooled air

upward to the plenum. Depending on the number of fan/filter units (FFUs) being serviced, additional Vertical Air Return modules may be required to ensure ample recirculated air supply to the FFUs. Adjustable baffles on the A/C modules allow some fresh make-up air to enter the system.

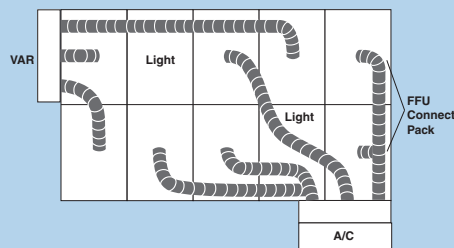

Cleanroom with HVAC module, Vertical Air Return and FFU Connect packs

### Ducted Applications:

Air Conditioning without a Ceiling Plenum

In these structures, cooled air is directed from the HVAC module upward through an air return module (included with the

A/C unit). This air return attaches to ductwork that feeds the Fan/Filter Units (FFUs) positioned on the cleanroom ceiling. A single A/C module can typically feed up to six FFUs.

Additional FFUs are typically fed air recirculated from the cleanroom through Vertical Air Returns, as shown in the illustration above. Depending on the number of fan/filter units (FFUs) being serviced, additional A/C or Vertical Air Return modules may be required. Adjustable baffles on the A/C modules allow some fresh make-up air to enter the system.

Each FFU requires an FFU Connect pack, which includes flexible ducting and all hardware required to connect and seal the duct.

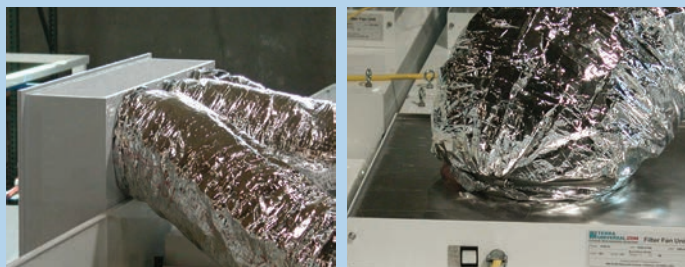

Vertical Air Return (left) ducted to FFU with Connect Pack (right)

**FFU Connect Packs**

Includes needed ducting, duct splitters, mounting hardware	Cat. #	\$/Each
For Cleanrooms with up to 9' ceilings	<b>6601-00</b>	<b>110.00</b>
For Cleanrooms with ceilings over 9'	<b>6601-01</b>	<b>145.00</b>

# HIGH-VOLUME EXHAUST FANS

- Adjustable high-volume fans allows precise regulation of pressure inside a cleanroom or other enclosure
- HEPA-filtered model removes sub-micron powders and other particles to protect the external environment
- Ideal for operations with hazardous materials that require negative pressure inside the controlled environment
- Optional power control allows remote adjustment of fan speed to simplify air balancing

These high volume exhaust fans convert any enclosure into a negative-pressure room that safely contains biological materials, pharmaceutical powders, and other potential environmental hazards.

Typically, exhaust air from the laminar-flow cleanroom is passed to the exhaust fan by means of take-up ducts located along the room perimeter (see illustration). By adjusting the high-volume fan, you can regulate the amount of air exhausted from and recirculated into the room to control the internal pressure. Recirculated air passes back into the room via a ceiling plenum chamber.



Negative-pressure containment BioSafe® cleanroom, showing return ducts to ceiling-mounted exhaust fans.

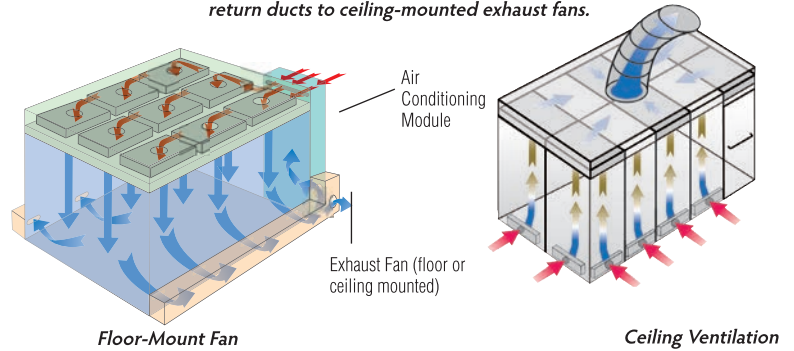

No. 6602-45: 3-phase model can be remotely controlled

### A. 3-Phase High-Volume Exhaust Fan

This compact unit includes a 2410 RPM fan that provides 1420 CFM of exhaust flow at 0"SP (average velocity: 2,595 feet/minute, exhausted to 10"-dia. duct). Dimensions: 26"W (including intake duct) x 23"D x 27"H. Intake flange: 10" dia. Exhaust flange: 7"W x 13"H. Weight: 140 lbs. Optional Variable Control System allow remote fan speed adjustment of multiple units.

High-Volume Exhaust Fan (220VAC, 50/60hz, 3 phase)  
Variable Control System  
Allows speed control of multiple units from a remote console

Cat. #	S/Each
6602-45-220	2,778.00
6602-25	Call TUI

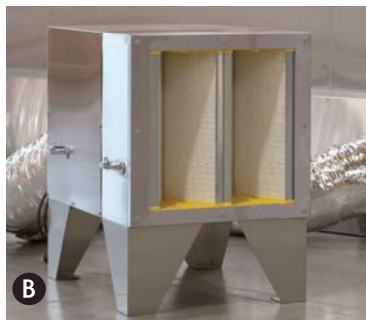

### B. Floor-Mount High-Volume Exhaust Fans

These models are ideal for high-volume removal of non-hazardous exhaust. An available filter removes up to 95% of particles 0.5 microns and larger

A. High-Volume Air Handlers (includes 10"- diameter x 2" flange)				Corresponding Exit Filters				
Air Flow		Motor Size	120VAC, 60Hz	220VAC, 50/60Hz	90-95% efficient@0.5µm			
@ 0" SP	@ 1" SP		Cat. #	S/Each	Cat. #	S/Each	Cat. #	
5340 CFM	4117 CFM	1.5 HP	6710-76	6,286.00	6710-76-220	6,286.00	6710-59	218.00
2418 CFM	2012 CFM	1 HP	6710-67	4,715.00	6710-67-220	4,715.00	6710-64	121.00

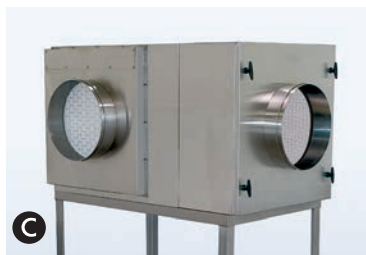

### C. HEPA-Filtered High-Volume Exhaust Fan

Provides up to 3200 CFM (3000 CFM average) exhaust of HEPA-filtered air (99.99% efficient at 0.3 micron particles). It can be used both as an exhaust fan and as a source of clean air to a remote enclosure. Dimensions: 30"W x 48"D x 31"H (67" with built-in stand). Includes stainless steel housing with 16"-diameter inlet/outlet flanges.

	Cat. #	S/Each
120 VAC	6710-68	6,690.00
208 VAC	6710-68-208	6,529.00
HEPA Filter (two required)	2100-20	411.00

Stainless steel BioSafe®  
Compounding Cleanroom: custom  
configuration shown with optional  
air conditioning module

# USP-797 & 800 MODULAR COMPOUNDING CLEANROOMS

Terra's USP-797 Compounding Cleanrooms exceed the ISO 7 requirements of USP-797, making them ideal for compounding sterile injectables and other critical operations. Select among standard floor plans, or specify a custom dimension. All models feature aluminum entry doors and internal partitions that separate the antechamber for personnel gowning or product staging.

USP-797 rooms include three HEPA filter/fan units that provide a total of 1950 CFM (3315 m3/hr.) of 99.99% particle-free air (measured at 0.3 micron diameter) – see ordering information. USP-800 models, designed for hazardous-drug compounding, are available in many standard configurations.

The main compounding room accommodates a number of aseptic compounding glovebox or laminar flow benches, which create an ISO 5 compounding zone. A separate ante-room functions as a gowning area, per USP regulations.

Compounding Cleanrooms do not include floors; they are designed for installation on a flat, sealed, non-particulating, crevice-free surface, which can be caulked to the clean room frame to form a seal.

Dual Magnehelic® pressure gauges, located on the outer control panel, monitor the cascading pressure levels in the anteroom and main room, simplifying USP-797 certification.

### Double-wall stainless steel BioSafe® design: The ideal solution for aseptic requirements

These cleanrooms incorporate double-wall, free-standing stainless steel panels that simplify compliance with USP cleaning protocol.

The stainless steel surfaces stand up to daily cleaning with alcohol and other harsh sterilizing agents, protecting your investment in a durable compounding environment. Internal walls are covered for easy wipe-down, and outlets and other utilities are flush-mounted to eliminate horizontal surfaces where contaminants can collect. Seams can be easily caulked for optimal cleanliness.

Best of all, these structures are designed for fast, easy do-it-yourself installation. Interior and exterior panels literally snap together, and adjacent panels are connected using a few screws. This design eliminates the need for internal support frames, drywall installation or panel adhesives, reducing both time and expense associated with installation.



- All standard room configurations meet and often exceed the cleanliness ratings required by USP 797 and USP 800
- Double-wall, insulated 304 stainless steel panels with radius corners provide smooth, ISO 5-compatible interior surfaces that stand up to daily cleaning and sterilizing procedure
- Standard configurations include ISO 7 compounding room and ISO 8 ante-room
- Optional Environmental Control Systems automatically record differential pressure data for auditing purposes
- Internal partition with hands-free swing door creates a separate ISO 8 ante-room for gowning and hand washing
- Snap-in-place wall panels create a rigid, durable structure that requires no external bracing or ceiling support

See ordering information below for USP-797-compliant cleanrooms. Containment cleanrooms for hazardous drug compounding, compliant with USP-800, are available in many configurations to meet DQSA 503A and 503B requirements; see complete specifications at TerraUniversal.com.

USP 797-Compliant Compounding Clean Rooms		7-ft Ceiling Height		8-ft Ceiling Height	
Overall Dimensions L x W Ft. (mm)	Panel Type	Cat. #	S/Each	Cat. #	S/Each
8 x 6 (2438 x 1829)	304 Stainless Steel	2900-52C-SS	14,365.00	2900-71-SS	14,733.00
10 x 6 (3048 x 1829)	304 Stainless Steel	2900-53C-SS	15,310.00	2900-72-SS	15,730.00
10 x 10 (3048 x 3048)	304 Stainless Steel	2900-37-SS	26,812.00	2900-91-SS	27,862.00
12 x 12 (3658 x 3658)	304 Stainless Steel	2900-75-SS	34,295.00	2900-94-SS	35,555.00

Call your Terra Product Specialist to discuss installation options.

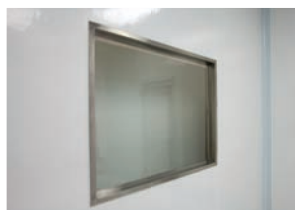

Stainless Steel Window



Stainless Steel Door



Fan Filter Status Light



Air conditioning modules available

**Dual Purpose HD/Non-HD Compounding Cleanroom**  
Complies with: USP 797 and USP 800

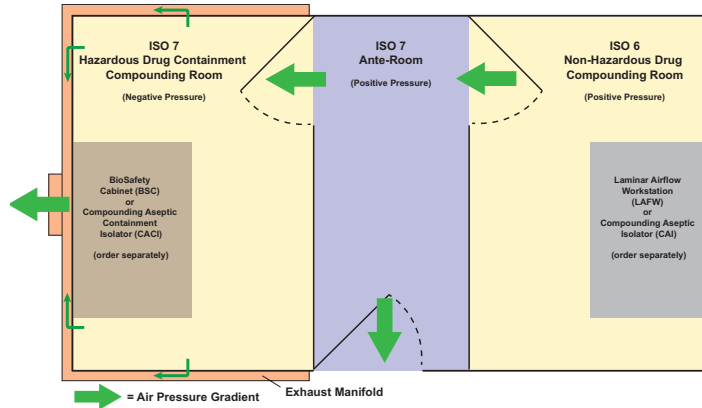

**HD Compounding Cleanroom**  
Complies with: USP 797 and USP 800

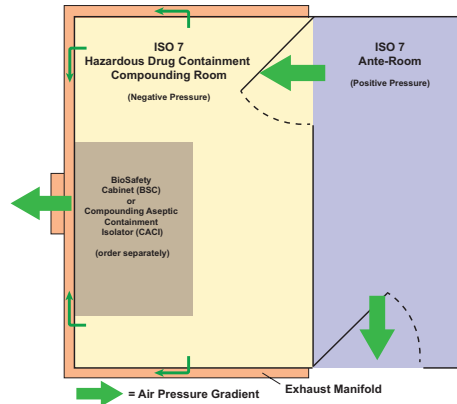

**Standard floorplans include USP-800 rooms configured for hazardous drug compounding!**

Hazardous drug compounding areas include negative-pressure containment to comply with USP-800 and Drug Quality and Security Act section 503(B) provisions. Call to discuss your application.

## SMART MODULAR CLEANROOM CONTROL SYSTEMS

- Simplifies and speeds up certification to USP, FDA and cGMP requirements!
- Control console provides room-by-room monitoring and control of fan/filter units (FFU) to help you maintain target pressure, temperature, humidity and particle levels based on sensor feedback

- Each system can be customized to fit individual budgets and requirements
- Tier Two system includes real-time data logging, providing a traceable history of cleanroom processing conditions (pressure, temperature and humidity)



**Tier One: Individual FFU/Room Control with Sensor Feedback**

This console can control the speeds of up to 50 fans and five rooms independently from a single graphical screen display. It also has the capability to display sensor feedback from any sensors added to the system, allowing you to view temperature, humidity, or pressure levels and adjust the fan speeds accordingly— all on a single console!

This system operates with EC motor FFUs and includes seven-day calendar set-back scheduling to conserve energy when the room is not in use.



**Tier Two: Individual FFU/Room Control with Environmental Monitoring and Data Logging**

This control level features a color 3.5" touchscreen control panel that includes an Ethernet port and the ability to log sensor data, as well as possible integration with a Building Automation System (BAS).

The automatic data logging feature provides traceable evidence of environmental conditions within the cleanroom, reducing the amount of time spent by personnel on

FDA compliance. The larger console monitors and controls up to 100 Fan/Filter Units that can be configured for up to 8 rooms.

	Cat. #	\$/Each
Tier 1 Smart Control System	6702-83	call TUI

	Cat. #	\$/Each
Tier 2 Smart Control System	6702-84	call TUI

# CLEANROOM STEP STOOLS AND LADDERS



**A** No. 2805-50A-2



**B** No. 2805-51A-2



**F** No. 2805-55A-2

No. 2805-57-2:  
Heavy-duty design  
supports 500 lbs. on  
platform



**G**



**H**



**K**

Fold for easy storage



**L**

**N**

**M**

Models above are electropolished 304 stainless steel and include spring-loaded, non-corroding stainless steel safety casters that retract under load. Perforations limit particle accumulation. (Folding models feature non-contaminating, non-skid nylon feet with stainless steel stem.) 316 stainless steel models available, along with CleanSeam™ versions that feature continuous, sanitary-grade welds to AWS D18.1/D18.2 specification, which create highly cleanable surfaces and eliminate cracks that can harbor contaminants (ordering information at TerraUniversal.com).

## 304 Stainless Steel Step Stools and Ladders

	Top Platform (W" x D")	Overall Dimensions (W" x D" x H")	No. of Steps	Electropolished 304 Stainless Steel	
				Cat. #	S/Each
<b>A</b>	30 x 14	30 x 20 x 24	2	<b>2805-50A-2</b>	<b>2,072.00</b>
<b>B</b>	30 x 12	30 x 28 x 34	3	<b>2805-51A-2</b>	<b>2,611.00</b>
<b>C</b>	30 x 12	30 x 34 x 60	3*	<b>2805-53A-2</b>	<b>3,021.00</b>
<b>D</b>	30 x 12	30 x 36 x 70	4*	<b>2805-52A-2</b>	<b>4,228.00</b>
<b>E</b>	30 x 16	30 x 40 x 80	5*	<b>2805-54A-2</b>	<b>5,410.00</b>
<b>F</b>	30 x 36	30 x 76 x 86	5*	<b>2805-55A-2</b>	<b>5,658.00</b>
<b>G</b>	24 x 48	48 x 63 x 92	5*	<b>2805-57-2</b>	<b>8,935.00</b>
<b>H</b>	14.5 x 12.5	35 x 77 x 113	10	<b>2805-49</b>	<b>6,700.00</b>
<b>I</b>	14.5 x 12.5	31 x 63.5 x 91	7	<b>2805-48</b>	<b>5,402.00</b>
<b>J</b>	14.5 x 12.5	27 x 50 x 68	6	<b>2805-47</b>	<b>4,520.00</b>
<b>K</b>	11 x 17	21 x 27 x 48	3	<b>2805-97</b>	<b>2,576.00</b>
<b>L</b>	15 x 10	18 x 16 x 20	1	<b>2805-80A</b>	<b>1,032.00</b>
<b>M</b>	15 x 10	18 x 22 x 35	2	<b>2805-81A</b>	<b>1,438.00</b>
<b>N</b>	16 x 10	18 x 25 x 44	3	<b>2805-82A</b>	<b>1,738.00</b>

\* Includes safety handrail. C, D, E, & J not shown. Styles H – J are collapsible, 316 SS available.

# CLEANROOM WASTE RECEPTACLES

These foot-pedal operated receptacles are available in several designs to meet your cleanroom requirements. All models include a rigid plastic liner with an EPA-registered anti-microbial compound for easy cleaning after waste removal.

**BioSafe® Receptacles**—The ultimate in cleanroom waste disposal, these models feature a soft-close mechanism that eliminates jarring noise and turbulence when lids close. Choose electropolished 304/316 stainless steel for stringent particle requirements, or polypropylene for use with caustic chemicals. Both designs include contoured, tight-fitting lids and a bottom that can be removed for easy cleaning and sterilization. All models eliminate cracks and crevices where germs accumulate and grow, and their one-piece construction includes a non-corroding base.

**ValuLine™ Receptacles**—Made of 304 stainless steel, these receptacles safely contain waste and feature gasketed seals to eliminate particle outflow. Non-stainless steel legs raise the receptacles 0.75" to provide air circulation and minimize particle accumulation.



*BioSafe hinge minimizes crevices that collect dust, germs*

*Removable bottom simplifies cleaning*



## Cleanroom Garment Hamper

Polypropylene construction combines cleanliness and chemical resistance, making this hamper suitable for use around a variety of cleanroom and laboratory environments. The recessed foot pedal allows hands-free operation, and its soft-close mechanism minimizes noise and turbulence when the lid drops. Standard design features over seven cubic feet of capacity; custom sizes available.

Outside Dimensions: 31"W x 14.5"D x 42"H  
 Inside Dimensions: 29.5"W x 11.5"D x 35"H

Cat. # S/Each  
 5151-51A 803.00

### BioSafe Cleanroom Waste Receptacles

Type	Capacity (Gallons)	Dimensions W x D x H (in.)	Ship. Wt. (lbs.)	Electropolished 304 Stainless Steel		Ship. Wt. (lbs.)	Polypropylene		ValuLine Waste Receptacles 304 Stainless Steel	
				Cat. #	S/Each		Cat. #	S/Each	Cat. #	S/Each
A	3.5	11 dia. x 17 H	9	—	—	9	—	—	1456-00	277.00
B	7	12 x 12 x 17	19	1456-16B	815.00	19	1456-25A	654.00	1456-01	446.00
C	12	12 x 12 x 23	24	1456-17B	1,050.00	24	1456-26A	799.00	1456-02	506.00
D	24	15 x 15 x 30	36	1456-18B	1,214.00	36	1456-27A	917.00	1456-03	659.00
E	40	19 x 19 x 30	48	1456-19B	1,689.00	48	1456-28A	1,141.00	1456-04	1,016.00



## Dual-Sided BioSafe® Cleanroom Mirror (No. 5252-65A – see page 32)

Enhances Compliance with Gowning Protocol!

- Frameless design and electropolished 304 stainless steel base simplify cleaning, sterilization
- Minimizes congestion by providing two viewing surfaces
- Easy to position anywhere you need it
- Creates natural division between gowning and final check areas of your change room

### Garment Cabinets (No. 4101-62A)

- Multiple configurations: hanging rods, shelves, or combination rod/shelves
- 304 stainless or powder-coated steel
- HEPA filter module (optional) maintains vertical flow of particle-free air to prevent dust build-up
- Ordering information: page 36



### Gowning Benches (See page 32)

These ultra-clean electropolished stainless steel benches won't shed particles or snag wipers during cleaning. Terra offers several designs, including cylindrical-tube models in sizes from 36" to 84" long. Visit [TerraUniversal.com](http://TerraUniversal.com) for full details.

# GOWNING BENCHES



Terra's all-electropolished 304 stainless steel gowning benches provide the ideal gowning surface. Their ultra-smooth surfaces won't shed particles or snag wipers. Choose among four designs; all freestanding models come with durable nylon leveling feet. Perforated top and 316 stainless steel models available at TerraUniversal.com.



Select Models

**Bootie Racks**  
(available on free-standing benches with square-tube frames)



Floor Mounted (see photo A)			Free Standing Design (see photos B, C, D)				Bootie Rack** (see photo E)					
L" x W" x H" Nominal	A. Solid Top		L" x W" x H" Nominal	B. Solid Top		C. Tubular Top		D. Cylinder-Frame/Tube-Top	No. of Slots	E. Installed		
	Cat. #	S/Each		Cat. #	S/Each	Cat. #	S/Each			Cat. #	S/Each	
36 x 9 x 18	1530-15-2	919.00	36 x 16 x 18	1530-25-2	963.00	1530-10-2	1,331.00	9602-96	1,329.00	12	1560-30-2	698.00
48 x 9 x 18	1530-16-2	998.00	48 x 16 x 18	1530-26-2	1,063.00	1530-11-2	1,886.00	9602-97	1,520.00	15	1560-31-2	936.00
60 x 9 x 18	1530-17-2	1,051.00	60 x 16 x 18	1530-27-2	1,241.00	1530-12-2	2,015.00	9602-98	1,752.00	18	1560-32-2	927.00
72 x 9 x 18*	1530-18-2	1,152.00	72 x 16 x 18	1530-28-2	1,325.00	1530-13-2	2,162.00	9602-99	1,907.00	21	1560-33-2	1,044.00
84 x 9 x 18*	1530-19-2	1,209.00	84 x 16 x 18	1530-29-2	1,450.00	1530-14-2	2,579.00	9600-02	2,570.00	24	1560-34-2	1,159.00

# CLEANROOM MIRRORS—Provide a visual self-check to reinforce gowning protocol



No. 5252-52A



**BioSafe® Frameless Cleanroom Wall-mount Mirrors—ideal for aseptic environments. Shown: No. 5252-60A**

## Dual-Sided Mirrors (see page 30)

This freestanding, frameless mirror includes a solid, electropolished 304 stainless steel base that cushions the dual-sided plate glass in nonoutgassing polyurethane. 35.5"W x 21"D x 73.5"H (35.5"W x 60.5" viewing area).

Cat. # S/Each  
5252-65A 2,334.00

## Wall-Mounted Mirrors

**Frameless models** feature a recessed mounting plate for flush-mounting on the cleanroom wall without rear offset space that can accumulate dust and germs. Caulking creates an easy-clean surface that acts as a germ barrier. Framed models include an ultra-smooth, mirror-finish SS frame with sloping edges to minimize particle build-ups.

Size W" x H"	With Frame		Frameless	
	Cat. #	S/Each	Cat. #	S/Each
<b>Heavy Duty</b>				
36 x 72	5252-52A	1,645.00	5252-58B	1,327.00
24 x 36	5252-53	1,108.00	5252-61B	935.00
18 x 24	5252-54	758.00	5252-60B	609.00
24 x 72	5252-55	1,359.00	5252-59B	1,093.00
24 x 48	5252-56	1,272.00	5252-63B	1,068.00
18 x 36	5252-57	997.00	5252-62B	879.00



### Nilfisk Cleanroom Vacuum Cleaner With ULPA Filtration

A four-stage filtration system, which includes a final ULPA filter, rated 99.999% efficient @ 0.12 µm particles, and quiet operation (59 dBA at 6.5 feet) make this vacuum ideal for cleanroom use. Includes filter set and tool kit with two 22" stainless steel tubes, 3" round brush, combination 12" floor nozzle, 6'6" conductive plastic hose, trolley, 30' power cord, conductive crevice nozzle and 5" utility nozzle. Tank capacity: 3.25 gallons.

	Cat. #	S/Each
120VAC	<b>1764-00</b>	<b>1,111.00</b>
240VAC	<b>1764-00-220</b>	<b>1,171.00</b>



### Minuteman® CRV Vacuum

Ideal for Class 1-100,000 facilities, this CRV features an electromagnetic/radio frequency interference filtration (RFI/EMI) for more stringent applications. The unit has a three-stage filtration system with a dual-layer disposable paper bag, a non-woven cloth filter and a standard ULPA filter. The quiet motor supplies powerful suction at a constant airflow with a noise level of 65 dba. The unit comes with a stainless steel four-wheel carriage for strength and mobility. Tank capacity: 4 gallons.

	Cat. #	S/Each
115VAC	<b>1001-65</b>	<b>1,357.00</b>



### Nilfisk SS Cleanroom Vacuum with Safe-Pak

Designed for cleanroom environments down to ISO 4 (Class 10), this compact and quiet cleanroom vacuum has the Safe-Pak function that effectively contains and disposes of hazardous materials. The multi-stage ULPA filtration system removes particles down to 0.12 microns at 99.999% efficiency. Safe-Pak can be interchanged with standard vacuum collection containers. Lightweight units are constructed with pharmaceutical standard AISI 316 stainless steel. Vacuum is easy to clean with autoclavable parts. Tank capacity: 3.25 gallons.

	Cat. #	S/Each
110/120V	<b>1764-37</b>	<b>1,658.00</b>
Safe-Pak Replacement Collection Container	<b>1764-43</b>	<b>356.00</b>



### Compact, Versatile MicroVac™ — Vacuum or Clear Air Blower

- Includes 99.999% efficient ULPA filter to capture sub-micron particulates
- Four-stage filtering system
- Ideal for cleaning up hazardous powders, pharmaceutical spills
- Ventilates bio cabinets, glove boxes and other small enclosures
- Provides burst of particle-free air to clean keyboards, PCBs and other delicate surfaces
- Mini-tool kit pinpoints small surface features

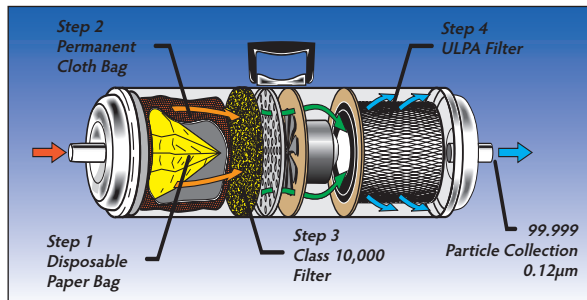

### Triple-Duty Cleaning —

- Cleans up dust and chemical spills
- Clean air blower pinpoints ULPA-filtered air
- Ventilates glove box or other enclosure

MicroVac	Cat. #	S/Each
110VAC/60Hz	<b>5100-00</b>	<b>1,219.00</b>
220VAC/50Hz	<b>5100-00-220</b>	<b>1,346.00</b>
<b>MicroVac Tool Kit</b>	<b>5100-05</b>	<b>18.00</b>
<b>Replacement Filters</b>		
Stage 1 Disposable Paper Bag	<b>5100-01</b>	<b>89.00</b>
Stage 3 Class 10,000 Filter	<b>5100-02A</b>	<b>17.00</b>
Stage 4 Class Replacement ULPA Filter	<b>5100-04</b>	<b>173.00</b>

# SHOE CLEANERS

## A. Motorized Shoe Cleaner

Internal vacuum system removes contaminants on shoes.  
Five internal brushes clean deep into seams, welts.

	Cat. #	S/Each
110VAC, 50/60Hz	1784-14	2,658.00
220VAC, 50Hz	1784-14-220	3,132.00
Exhaust HEPA Filter Kit (includes filter)	1784-13	438.00

## B. Bulldog 351 Shoe Brush Machine by Liberty Industries

This sturdy unit quickly and easily brushes away dirt, mud, leaves, slush and sand from footwear. The 16-gauge stainless steel housing and nickel-plated shafts reduce corrosion. Includes non-abrasive rotating heavy-duty nylon brush and 6' power cord for 120V/60Hz operation. Units require a vacuum attachment (order separately below).

	Cat. #	S/Each
Bulldog 351	7575-00	4,391.00
Non-HEPA Wet/Dry Vacuum	7575-01	747.00
HEPA Dry-only Vacuum	7575-02	729.00

## C. Sticky Mats®

Peel-off sheets eliminate the need for messy cleaning and make it easy to maintain a clean surface. All below are medium tack; many other styles available.

Dimen. W" x D"	Blue (full bottom) Cat. #	S/Each	Grey (2" bottom) Cat. #	S/Each
18 x 36	5601-16	45.00	5602-20	43.00
18 x 45	5601-17	53.00	5602-21	49.00
24 x 36	5601-18	62.00	5602-22	60.00
26 x 45	5601-19	77.00	5602-23	74.00
36 x 36	5601-20	90.00	5602-24	90.00
36 x 45	5601-21	110.00	5602-25	107.00
36 x 60	5601-22	165.00	5602-26	165.00

Dimen. W" x D"	White (2" bottom) Cat. #	S/Each	Corresp. Frames Cat. #	S/Each
18 x 36	5602-68	43.00	5602-93	116.00
18 x 45	5602-69	49.00	5602-94	130.00
24 x 36	5602-70	60.00	5602-97	143.00
26 x 45	5602-71	74.00	5602-99	153.00
36 x 36	5602-72	90.00	5603-03	176.00
36 x 45	5602-73	107.00	5603-04	194.00
36 x 60	5602-74	165.00	5603-05	222.00

## D. Automatic Shoe Cover Dispenser & Remover by Protexer

Once shoes are cleaned, it's time to don shoe covers before entering the gowning room and garbing up. The KineticButler and BootieButler simplify this process, increasing proper shoe cover compliance and minimizing cross contamination. Both provide hands-free application and removal in seconds. Shoe cover refill bundles at [TerraUniversal.com](http://TerraUniversal.com)

### KineticButler Dispenser

	Cat. #	S/Each
Regular Capacity*	3619-01	228.00
High Capacity**	3619-00	443.00

### BootieButler Remover

	Cat. #	S/Each
Regular Capacity*	3619-03	2,147.00
High Capacity**	3619-02	2,640.00

\* Holds 55 pairs of one shoe cover bundles (applicator) / 500 pieces (remover)

\*\* Holds 110 pairs of two shoe cover bundles (applicator) / 1,000 pieces (remover)



# PUREDRY™ CLEANROOM HAND AND GLOVE DRYER

- Microfilters capture sub-micron particles to reduce contamination and germs that can spread infection
- Also ideal for drying tools, bottles, microelectronic components and other small particle-sensitive materials
- ULPA (Ultra Low Penetration Air) filter—ISO 5 compatible
- Insulation and motor isolation reduce noise
- Brushless motor eliminates carbon contaminants for ultra-clean operation



## Germ-Free Recirculating Model (No. 3333-33)

Eliminates filter clogs and germ accumulation.

## Single-Pass Model (No. 3333-00)

Space-saving, wall-mount unit features an easy-access ULPA filter.

PureDry Hand/Glove Dryer Recirculating Model		
Description	Cat. #	S/Each
120VAC/60Hz	3333-33	2,638.00
220VAC/50Hz	3333-33-220	2,638.00
Replacement ULPA Filter	3333-35	200.00
99.999% efficient@ 0.12 micron		

PureDry Hand/Glove Single Pass Model		
Description	Cat. #	S/Each
120VAC/60Hz	3333-00	2,092.00
220VAC/50Hz	3333-00-220	2,092.00
Replacement ULPA Filter	3333-39	180.00
99.999% efficient@ 0.12 micron		

## HAND AND GLOVE WASHING AND DRYING STATIONS

Terra specifically designed these integrated washing/drying stations for use in critical cleanroom and gowning room environments.

- Incorporates washing and ULPA-filtered drying modules in one cleanroom-compatible station
- Infrared (IR) beam activation for hands-free, non-contaminating operation
- Optional liquid soap dispenser
- Incorporates noise-absorbing insulation and isolated motor for quiet operation
- Drying module incorporates blower, energy-efficient heater with insulated air flow tubing, and an ULPA (ultra-low penetration air) filter rated 99.999% efficient @ 0.12 µm particles

*Brushless motor eliminates carbon contaminants for ultra-clean operation*



Hand/Glove Cleaning Station									
Dimensions Includes levelers W" x D" x H" Nominal	No. of Sinks	304 Stainless Steel				Electropolished 304 Stainless Steel			
		110VAC/60Hz		220VAC/50Hz		110VAC/60Hz		220VAC/50Hz	
		Cat. #	S/Each	Cat. #	S/Each	Cat. #	S/Each	Cat. #	S/Each
24 x 22 x 61	1	9600-60	5,681.00	9600-60-220	5,799.00	9600-05	7,214.00	9600-05-220	6,578.00
48 x 22 x 61	2	9600-61	11,180.00	9600-61-220	11,301.00	9600-06	12,834.00	9600-06-220	12,834.00
96 x 22 x 61	4	9600-62	20,677.00	9600-62-220	20,677.00	9600-07	24,181.00	9600-07-220	24,181.00
144 x 22 x 61	6	9600-63	31,329.00	9600-63-220	31,329.00	9600-08	36,584.00	9600-08-220	36,584.00

# CLEANROOM GARMENT STORAGE



Powder-Coated Steel



304 SS with steel door frames



Top component fits filter/blower or can be used as storage

Terra's versatile cleanroom storage cabinets house a variety of garments, booties, supplies, tools and process equipment. Select models are available with HEPA filter/blower that removes 99.99% of all contaminants 0.3 microns and larger. The chrome-plate hardware, nonshedding materials ensure cleanroom compatibility. Models have double doors with self-closing hinges that require minimum clearance and provide easy access to stored items. Type A cabinets accommodate up to 30 garments.

Cabinet doors can be ordered in clear acrylic or SD-PVC. All models include a 6"H (152 mm) stand with leveling feet.

Models are also available in 220V.

\* Acrylic is damaged by alcohol and other cleaning agents.

## Cleanroom Garment Storage Cabinets: Powder-Coated Steel

Specifications		Powder-Coated Steel				Powder-Coated Steel w/ Steel Door Frames				
Type	Dimensions W" x D" x H"	w/Acrylic Doors*		w/Dissp. PVC Doors		w/Acrylic Doors*		w/Dissp. PVC Doors		
		Cat. #	S/Each	Cat. #	S/Each	Cat. #	S/Each	Cat. #	S/Each	
A	Filter/Blower	40 x 26.5 x 94	4101-03C	2,533.00	4101-17C	2,733.00	4101-03C-HD	2,981.00	4101-17C-HD	3,332.00
		52 x 26.5 x 94	4101-01C	2,787.00	4101-15C	3,141.00	4101-01C-HD	3,235.00	4101-15C-HD	3,582.00
	Cabinet Only	40 x 26.5 x 94	4101-02C	1,769.00	4101-16C	2,123.00	4101-02C-HD	2,218.00	4101-16C-HD	2,564.00
B		52 x 26.5 x 94	4101-00C	2,012.00	4101-14C	2,371.00	4101-00C-HD	2,465.00	4101-14C-HD	2,812.00
	Filter/Blower	40 x 26.5 x 94	4101-04C	2,679.00	4101-18D	3,038.00	4101-04C-HD	3,132.00	4101-18D-HD	3,588.00
		52 x 26.5 x 94	4101-06C	2,947.00	4101-20D	3,307.00	4101-06C-HD	3,401.00	4101-20D-HD	3,748.00
C	Cabinet Only	40 x 26.5 x 94	4101-05C	1,869.00	4101-19D	2,228.00	4101-05C-HD	2,323.00	4101-19D-HD	2,669.00
		52 x 26.5 x 94	4101-07C	2,133.00	4101-21D	2,492.00	4101-07C-HD	2,310.00	4101-21D-HD	2,933.00
	Filter/Blower	40 x 26.5 x 94	4205-20C	2,492.00	4205-21C	2,492.00	4205-20C-HD	3,253.00	4205-21C-HD	2,933.00
	52 x 26.5 x 94	4205-22C	2,807.00	4205-23C	3,165.00	4205-22C-HD	3,243.00	4205-23C-HD	3,606.00	
Cabinet Only	40 x 26.5 x 94	4101-11C	1,779.00	4101-25C	2,138.00	4101-11C-HD	2,220.00	4101-25C-HD	2,579.00	
	52 x 26.5 x 94	4101-13C	2,030.00	4101-27C	2,651.00	4101-13C-HD	2,471.00	4101-27C-HD	2,830.00	

## Replacement HEPA Filter

For models with filter/blower unit. Rated 99.99% efficient @ 0.3 µm particles

Cat. # 1681-02 S/Each 363.00

## Cleanroom Hangers

Electropolished SS Closed Loop  
Cat. # 1530-30-2 S/Each 15.00

Detachable  
Cat. # 1530-31-2 S/Each 15.00



Items in blue



\* Acrylic is damaged by alcohol and strong cleaning agents

## Cleanroom Garment Storage Cabinets: 304 Stainless Steel

Specifications		304 Stainless Steel w/ shelves				304 Stainless Steel w/ SS Door Frames				
Type	Outside Dimensions W" x D" x H"	w/Acrylic Doors*		w/Dissp. PVC Doors		w/Acrylic Doors*		w/Dissp. PVC Doors		
		Cat. #	S/Each	Cat. #	S/Each	Cat. #	S/Each	Cat. #	S/Each	
A	Filter/Blower	40 x 26.5 x 94	4101-57B	5,008.00	4101-68B	5,367.00	4101-57B-HD	5,554.00	4101-68B-HD	5,913.00
		52 x 26.5 x 94	4101-59B	5,564.00	4101-70B	6,186.00	4101-59B-HD	6,110.00	4101-70B-HD	6,469.00
	Cabinet Only	40 x 26.5 x 94	4101-58B	4,080.00	4101-69B	4,440.00	4101-58B-HD	4,626.00	4101-69B-HD	4,986.00
B		52 x 26.5 x 94	4101-60B	4,729.00	4101-71B	5,351.00	4101-60B-HD	4,467.00	4101-71B-HD	5,634.00
	Filter/Blower	40 x 26.5 x 94	4101-61B	5,159.00	4101-72B	5,515.00	4101-61B-HD	5,705.00	4101-72B-HD	6,326.00
		52 x 26.5 x 94	4101-63B	5,731.00	4101-74B	6,090.00	4101-63B-HD	6,277.00	4101-74B-HD	6,636.00
C	Cabinet Only	40 x 26.5 x 94	4101-62B	4,206.00	4101-73B	4,566.00	4101-62B-HD	4,752.00	4101-73B-HD	5,112.00
		52 x 26.5 x 94	4101-64B	4,873.00	4101-75B	5,232.00	4101-64B-HD	5,419.00	4101-75B-HD	5,778.00
	Filter/Blower	40 x 26.5 x 94	4205-65B	5,030.00	4205-76B	5,389.00	4205-65B-HD	5,576.00	4205-76B-HD	5,935.00
	52 x 26.5 x 94	4205-67B	5,588.00	4205-78B	5,585.00	4205-67B-HD	6,134.00	4205-78B-HD	6,493.00	
Cabinet Only	40 x 26.5 x 94	4101-66B	4,098.00	4101-77B	4,457.00	4101-66B-HD	4,634.00	4101-77B-HD	5,003.00	
	52 x 26.5 x 94	4205-24C	4,750.00	4205-25C	5,109.00	4205-24C-HD	5,296.00	4205-25C-HD	5,655.00	

# GOWNING RACKS

## A./B. UltraClean™ Cylinder Tube Garment Racks

Made of high -grade electropolished stainless steel, these racks feature sloping 1½"-diameter cylindrical tube frames that are easy to wipe down. Fixed position design keeps garments firmly in place.

See ordering chart below.

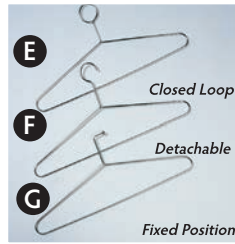

### Electropolished Cleanroom Hanger

Type	For Rack Type	Cat. #	S/Each
E	C	1530-30-2	15.00
F	A, B or C	1530-31-2	15.00
G	A, B or D	1530-32-2	15.00



## C. UltraClean™ Square Tube Garment Racks

These electropolished racks can be disassembled for easy storage and shipping. They are available with one or two hanger rods, in configurations for closed-loop or detachable hangers (photos C and D).

See ordering chart below.

## D. Fixed Position Hanger Rods

This style is available with square-tube racks. Slots at 3" increments keep garments from bunching together. Requires fixed-position hangers (photo G).

See ordering chart below.

Cylinder Frame Rack  
(1½"-diameter tubes)  
Overall height: 76"  
For use with detachable hangers.



Square-Tube Rack Sliding position style for use with closed-loop or detachable hangers. Overall height: 74"

QUICK Ship  
Select Models

### Electropolished Stainless Steel Garment Storage Racks

Type See photos above	Dimensions	Hanger Capacity (order separately)		A/B. Cylinder Tube Frame (order hanger 1530-32-2 separately)				C/D. Square Tube Frame			
		Single Rack	Dual Rack	A. Single-Rack		B. Dual-Rack		Single-Rack		Dual-Rack	
				Cat. #	S/Each	Cat. #	S/Each	Cat. #	S/Each	Cat. #	S/Each
C. Sliding Position (order closed loop or detachable hangers)	48"W x 24"D	15	30	—	—	—	—	9230-00-2	928.00	9230-04-2	1,498.00
	60"W x 24"D	19	38	—	—	—	—	9230-01-2	1,191.00	9230-05-2	1,681.00
	72"W x 24"D	23	46	—	—	—	—	9230-02-2	1,033.00	9230-06-2	2,010.00
	84"W x 24"D	27	54	—	—	—	—	9230-03-2	1,402.00	9230-07-2	2,158.00
A, B, & D. Fixed Position (order fixed position hangers)	48"W x 24"D	15	30	9602-67	1,407.00	9602-75	2,623.00	9230-08-2	1,109.00	9230-12-2	2,035.00
	60"W x 24"D	19	38	9602-68	1,729.00	9602-76	3,063.00	9230-09-2	1,379.00	9230-13-2	2,396.00
	72"W x 24"D	23	46	9602-69	1,883.00	9602-77	3,505.00	9230-10-2	1,500.00	9230-14-2	2,640.00
	84"W x 24"D	27	54	9602-70	2,061.00	9602-78	3,717.00	9230-11-2	1,635.00	9230-15-2	2,920.00

# CLEANROOM CHAIRS



## A. – E. Cleanroom Chairs

Clean vinyl meets Class 100 particle requirements. Static-Control chairs feature dissipative vinyl, conductive casters, and grounding chains.

Specs	Class 100 Static Control						Class 100						
	Height	Color	A.		B.		C.		D.		Color	E.	
			Cat. #	S/Each	Cat. #	S/Each	Cat. #	S/Each	Cat. #	S/Each		Cat. #	S/Each
Desk	Black		2802-61	362.00	2802-67	366.00	2802-73	374.00	1012-05	466.00	Black	—	—
	Blue		2802-62*	362.00	2802-68*	366.00	2802-74*	375.00	—	—	Black	1013-51	549.00
Bench	Black		2802-64	373.00	2802-70	386.00	2802-76	402.00	—	—	Black	—	—
	Blue		2802-65*	373.00	2802-71*	386.00	2802-77*	386.00	—	—	Black	1013-52	549.00

\* Quick ship models – usually ship within one week!

# CLEANROOM VIBRATION ISOLATION WORK STATIONS

Work Stations  
—see chart below



No. 1570-53A - Stainless Steel Top



Vibration-Free Platform			
Work Surface (W" x D" x H")	Maximum Load* (lbs.)	UltraClean™ Finish 304 Stainless Steel Top	S/Each
21.75 x 18.25 x 3	213	Cat. # <b>1580-02</b>	<b>2,062.00</b>
23 x 24 x 3	213	Cat. # <b>1580-03</b>	<b>2,222.00</b>

\* Internal plate weight should be removed before operation with net loads over 100 lbs.

Vibration-Free Work Stations Pneumatic vibration-free mounts isolate up to 90% of building vibration			Nonconductive Laminate Top		Static Dissipative Laminate Top		304 Stainless Steel Top		Electropolished Stainless Steel Top, Frame & Legs			
Work Surface Dimensions (W" x D")	Number of Isolators	Maximum Load* (lbs.)	"A" Base Design**		"A" Base Design**		w/ Finished CR Steel Frame, Legs "A" Base Design**		All Stainless Steel Construction "A" Base Design**			
			Cat. #	S/Each	Cat. #	S/Each	Cat. #	S/Each	Cat. #	S/Each		
48 x 30	4	360	1570-00A	1,704.00	1570-26A	1,872.00	1570-52A	2,060.00	1570-80A	2,458.00	1570-80A-2	2,780.00
60 x 30	4	350	1570-01A	1,732.00	1570-27A	1,902.00	1570-53A	2,124.00	1570-81A	2,544.00	1570-81A-2	2,896.00
72 x 30	6	550	1570-02A	1,744.00	1570-28A	1,920.00	1570-54A	2,168.00	1570-82A	2,638.00	1570-82A-2	3,003.00
84 x 30	6	540	1570-03A	1,789.00	1570-29A	2,056.00	1570-55A	2,268.00	1570-83A	2,764.00	1570-83A-2	3,182.00
96 x 30	6	530	1570-04A	1,974.00	1570-30A	2,246.00	1570-56A	2,454.00	1570-84A	2,974.00	1570-84A-2	3,389.00
48 x 34	4	360	1570-07A	1,659.00	1570-33A	1,896.00	1570-59A	2,125.00	1570-87A	2,536.00	1570-87A-2	2,753.00
60 x 34	4	350	1570-08A	1,705.00	1570-34A	1,943.00	1570-60A	2,222.00	1570-88A	2,620.00	1570-88A-2	2,972.00
72 x 34	6	550	1570-09A	1,784.00	1570-35A	1,966.00	1570-61A	2,348.00	1570-89A	2,764.00	1570-89A-2	3,150.00
84 x 34	6	540	1570-10A	1,872.00	1570-36A	2,135.00	1570-62A	2,423.00	1570-90A	2,993.00	1570-90A-2	3,119.00
96 x 34	6	530	1570-11A	1,998.00	1570-37A	2,338.00	1570-63A	2,632.00	1570-91A	3,126.00	1570-91A-2	3,275.00

\* Maximum loads with plate weights removed.

\*\* Nonadjustable (one piece) legs also available with "A" base design at no extra cost (specify when ordering).



## High-Performance Vibration Isolation Tables, from TMC

- Patented Gimbal Piston™ Isolators achieve both horizontal and vertical isolation down to very low input levels (complete isolation specs at TerraUniversal.com)
- Modular, ergonomic design enhances functionality and comfort
- Cleanroom-compatible configuration includes ducted air exhaust for clean, particle-free operation

These vibration-isolation tables are ideal for applications in electrophysiology, cell injection, photomicroscopy and other critical applications. All models come with stainless steel top; cleanroom-compatible models include all-SS construction and ducted exhaust. Isolation efficiency: 90 – 97% @ 10Hz. Low input specification (natural frequency): 1.5 – 2.0Hz (vertical), 1.2 – 1.7Hz (horizontal). Net load capacity: 500 lbs. Requires 80 psi air or nitrogen.

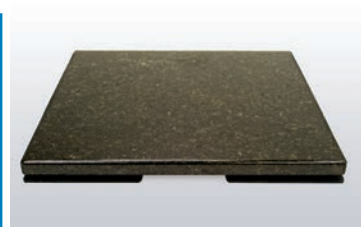

## Granite Isolator

- Low-cost, easy-clean platform—simple design requires no air supply
- Polished granite rests on silicone isolators, providing 2.4Hz horizontal natural frequency

Top (W x D)	Cat. #	S/Each
13" x 15"	1580-20	442.00
16" x 21"	1580-21	683.00
18" x 26"	1580-23	975.00

Top Dimensions (W x D)	Stainless Steel Top with Powder-Coated Frame		All-Stainless Steel Cleanroom Models*	
	Cat. #	S/Each	Cat. #	S/Each
30" x 30"	3435-12	3,575.00	—	—
36" x 30"	3435-13	3,401.00	3435-00	5,753.00
48" x 30"	3435-14	3,471.00	3435-01	5,863.00
60" x 30"	3435-15	3,620.00	—	—
48" x 36"	3435-16	3,565.00	3435-02	6,086.00
60" x 36"	3435-17	3,724.00	3435-03	6,186.00

\* Includes armrest. Available with electropolished finish.



# STAINLESS STEEL CLEANROOM WORK BENCHES

# HEAVY DUTY Square Tube Bases

Advanced Technology

## Heavy-Duty All-Electropolished Stainless Steel Work Stations (800-lb. load capacity)

**QuietTop™ Rods**  
with Full Bullnose  
ø 1/4" rods on  
1" centers

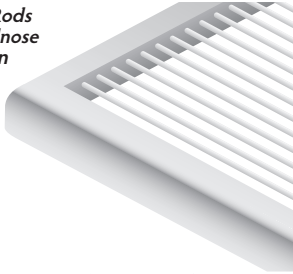

**OpenTop™ Perforated**  
with ErgoEdge™  
Rounded Front  
ø 1/4" holes

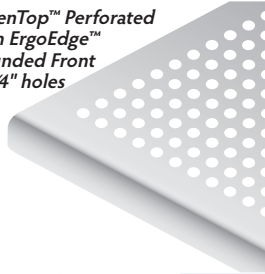

**OpenTop Perforated**  
with ErgoEdge  
Rounded Front  
ø 3/4" holes

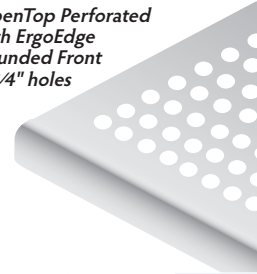

**Solid Top with**  
ErgoEdge Rounded  
Front

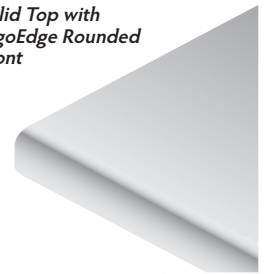

Bench Size <sup>(1)</sup> (W" x D")	"A" Base			"C" Base			"A" Base			"C" Base		
	Cat. #	Cat. #	S/Each <sup>(1)</sup>	Cat. #	Cat. #	S/Each <sup>(1)</sup>	Cat. #	Cat. #	S/Each <sup>(1)</sup>	Cat. #	Cat. #	S/Each <sup>(1)</sup>
24 x 24	9601-01	9601-02	1,409.00	9604-51	9604-72	1,450.00	9601-43	9601-44	1,353.00	9601-85	9601-86	1,118.00
36 x 24	9601-03	9601-04	1,561.00	9604-52	9604-73	1,563.00	9601-45	9601-46	1,451.00	9601-87	9601-88	1,183.00
48 x 24	9601-05	9601-06	1,804.00	9604-53	9604-74	2,085.00	9601-47	9601-48	1,896.00	9601-89	9601-90	1,446.00
60 x 24	9601-07	9601-08	2,028.00	9604-54	9604-75	2,282.00	9601-49	9601-50	2,015.00	9601-91	9601-92	1,494.00
72 x 24	9601-09	9601-10	2,250.00	9604-55	9604-76	2,513.00	9601-51	9601-52	2,228.00	9601-93	9601-94	1,664.00
84 x 24	9601-11	9601-12	2,526.00	9604-56	9604-77	2,636.00	9601-53	9601-54	2,303.00	9601-95	9601-96	1,854.00
96 x 24	9601-13	9601-14	2,785.00	9604-57	9604-78	3,016.00	9601-55	9601-56	2,636.00	9601-97	9601-98	2,050.00
24 x 30	9601-15	9601-16	1,570.00	9604-58	9604-79	1,517.00	9601-57	9601-58	1,420.00	9601-99	9603-00	1,161.00
36 x 30	9601-17	9601-18	1,686.00	9604-59	9604-80	1,636.00	9601-59	9601-60	1,494.00	9603-01	9603-02	1,314.00
48 x 30	9601-19	9601-20	1,895.00	9604-60	9604-81	2,210.00	9601-61	9601-62	2,085.00	9603-03	9603-04	1,512.00
60 x 30	9601-21	9601-22	2,124.00	9604-61	9604-82	2,347.00	9601-63	9601-64	2,111.00	9603-05	9603-06	1,637.00
72 x 30	9601-23	9601-24	2,484.00	9604-62	9604-83	2,625.00	9601-65	9601-66	2,205.00	9603-07	9603-08	1,830.00
84 x 30	9601-25	9601-26	2,645.00	9604-63	9604-84	2,746.00	9601-67	9601-68	2,342.00	9603-09	9603-10	2,038.00
96 x 30	9601-27	9601-28	3,028.00	9604-64	9604-85	3,249.00	9601-69	9601-70	2,871.00	9603-11	9603-12	2,346.00
24 x 36	9601-29	9601-30	1,650.00	9604-65	9604-86	1,581.00	9601-71	9601-72	1,487.00	9603-13	9603-14	1,243.00
36 x 36	9601-31	9601-32	1,895.00	9604-66	9604-87	1,742.00	9601-73	9601-74	1,601.00	9603-15	9603-16	1,457.00
48 x 36	9601-33	9601-34	2,074.00	9604-67	9604-88	2,231.00	9601-75	9601-76	2,044.00	9603-17	9603-18	1,601.00
60 x 36	9601-35	9601-36	2,321.00	9604-68	9604-89	2,407.00	9601-77	9601-78	2,169.00	9603-19	9603-20	1,710.00
72 x 36	9601-37	9601-38	2,497.00	9604-69	9604-90	2,616.00	9601-79	9601-80	2,333.00	9603-21	9603-22	1,890.00
84 x 36	9601-39	9601-40	2,785.00	9604-70	9604-91	2,791.00	9601-81	9601-82	2,457.00	9603-23	9603-24	2,044.00
96 x 36	9601-41	9601-42	3,055.00	9604-71	9604-92	3,337.00	9601-83	9601-84	2,961.00	9603-25	9603-26	2,285.00

<sup>(1)</sup> Prices for "A" base and "C" base designs are the same. Standard height is 30" (floor to top). Heights of 32" and 36" and widths of 34" are available at no extra charge. Specify when ordering.



### Cleanroom Drawers

No. of Drawers	Min. Drawer Height	304 Stainless Steel (16"W x 18"D)	
		Cat. #	S/Each
1	6"	1741-20	226.00
1	12"	1741-21	351.00
2	6", 6"	1741-22	450.00
2	6", 12"	1741-23	626.00
3	6", 6", 6"	1741-24	772.00



Model Shown: No. 9601-87  
36"W x 24"D with "A" Base

### Solid-Top Tables

- Full bull-nosed front edge, in two frame designs
- "A" base, shown above, features non-adjustable legs to avoid metal-on-metal contact



Model Shown: No. 9601-20  
48"W x 30"D with recessed "C" Base

### Rod-Top Tables

- Rods float in non-outgassing elastomer, minimizing noise and vibration

# LIGHT DUTY Square Tube Bases

# STAINLESS STEEL CLEANROOM WORK BENCHES

## Advanced Technology

Light-Duty All-Electropolished Stainless Steel Work Stations (800-lb. load capacity, "A" & "C" bases are 1" square tubes)

QuietTop™ Rods  
with Full Bullnose  
ø 1/4" rods on  
1" centers

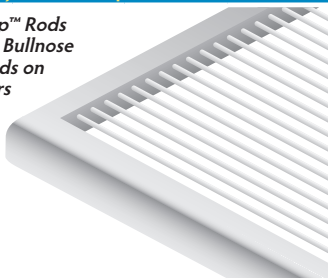

OpenTop™ Perforated  
with ErgoEdge™  
Rounded Front  
ø 1/4" holes

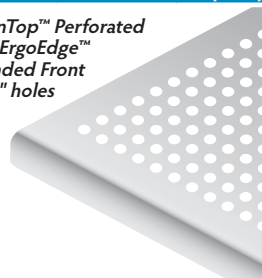

OpenTop Perforated  
with ErgoEdge  
Rounded Front  
ø 3/4" holes

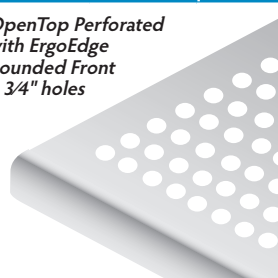

Solid Top with  
ErgoEdge Rounded  
Front

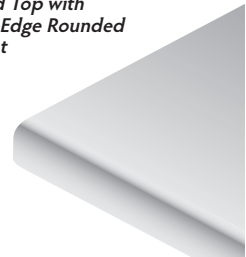

Bench Size (W" x D")	"A" Base			"C" Base			"A" Base			"C" Base		
	Cat. #	Cat. #	S/Each (1)	Cat. #	Cat. #	S/Each (1)	Cat. #	Cat. #	S/Each (1)	Cat. #	Cat. #	S/Each (1)
24 x 24	9603-90	9603-91	1,397.00	9604-93	9605-02	1,204.00	9604-08	9604-09	1,161.00	9604-26	9604-27	1,096.00
36 x 24	9603-92	9603-93	1,517.00	9604-94	9605-03	1,318.00	9604-10	9604-11	1,236.00	9604-28	9604-29	1,135.00
48 x 24	9603-94	9603-95	1,661.00	9604-95	9605-04	1,518.00	9604-12	9604-13	1,395.00	9604-30	9604-31	1,267.00
24 x 30	9603-96	9603-97	1,441.00	9604-96	9605-05	1,217.00	9604-14	9604-15	1,173.00	9604-32	9604-33	1,135.00
36 x 30	9603-98	9603-99	1,695.00	9604-97	9605-06	1,441.00	9604-16	9604-17	1,364.00	9604-34	9604-35	1,261.00
48 x 30	9604-00	9604-01	1,918.00	9604-98	9605-07	1,659.00	9604-18	9604-19	1,538.00	9604-36	9604-37	1,418.00
24 x 36	9604-02	9604-03	1,602.00	9604-99	9605-08	1,282.00	9604-20	9604-21	1,245.00	9604-38	9604-39	1,169.00
36 x 36	9604-04	9604-05	1,779.00	9605-00	9605-09	1,545.00	9604-22	9604-23	1,470.00	9604-40	9604-41	1,406.00
48 x 36	9604-06	9604-07	1,964.00	9605-01	9605-10	1,714.00	9604-24	9604-25	1,601.00	9604-42	9604-43	1,432.00

(1) Prices for "A" base and "C" base designs are the same. Standard height is 30" (floor to top). Heights of 32" and 36" and widths of 34" are available at no extra charge. Specify when ordering.



Perforated shelves now available!

### Above-Bench Shelf

Support uprights can be added to any standard Terra work station to accommodate an overtop shelf made of 1/4"-diameter rods on 2" centers. Standard height of a 12"D shelf is 12" above the bench surface (custom shelf depths and heights are available).



### Under-Bench Shelf

Standard mounting is 21 1/2" above the floor. Select 12"D or 18"D (custom shelf depths and heights are available). Made of 1/4"-diameter rods on 2" centers.

### Base Styles

Heavy Duty — 1 1/2" x 1 1/2" square tubes  
Light Duty — 1" x 1" square tubes



"A" Base

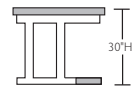

"C" Base

	For Bench Width	Rod Shelves (1/4" rods on 2" centers)						Perforated Shelves (3/4" holes)					
		Above-Bench		Under-Bench				Above-Bench		Under-Bench			
		12"D, fixed 12" above bench	12"D, fixed 21.5" above floor	12"D, fixed 21.5" above floor	18"D, fixed 21.5" above floor	12"D, fixed 12" above bench	12"D, fixed 21.5" above floor	18"D, fixed 21.5" above floor	12"D, fixed 12" above bench	12"D, fixed 21.5" above floor	18"D, fixed 21.5" above floor		
		Cat. #	S/Each	Cat. #	S/Each	Cat. #	S/Each	Cat. #	S/Each	Cat. #	S/Each	Cat. #	S/Each
For "C" Bases	24"	1530-69-2	443.00	1530-68-2	327.00	1530-67-2	434.00	1534-00-2	361.00	1534-07-2	298.00	1534-14-2	393.00
	36"	1530-86-2	434.00	1530-87-2	398.00	1530-88-2	504.00	1534-01-2	393.00	1534-08-2	361.00	1534-15-2	459.00
	48"	1530-53-2	467.00	1525-61-2	434.00	1525-62-2	521.00	1534-02-2	425.00	1534-09-2	393.00	1534-16-2	479.00
	60"	1530-54-2	521.00	1525-80-2	467.00	1525-84-2	610.00	1534-03-2	476.00	1534-10-2	425.00	1534-17-2	554.00
	72"	1530-55-2	618.00	1525-81-2	504.00	1525-85-2	663.00	1534-04-2	561.00	1534-11-2	459.00	1534-18-2	604.00
	84"	1530-56-2	793.00	1525-82-2	574.00	1525-86-2	876.00	1534-05-2	653.00	1534-12-2	521.00	1534-19-2	796.00
For "A" Bases	96"	1530-57-2	796.00	1525-83-2	839.00	1525-87-2	982.00	1534-06-2	725.00	1534-13-2	764.00	1534-20-2	891.00
	24"	1527-65-2	398.00	1527-72-2	327.00	1527-79-2	434.00	1534-21-2	361.00	1534-28-2	298.00	1534-35-2	393.00
	36"	1527-66-2	434.00	1527-73-2	398.00	1527-80-2	504.00	1534-22-2	393.00	1534-29-2	361.00	1534-36-2	459.00
	48"	1527-67-2	467.00	1527-74-2	434.00	1527-81-2	521.00	1534-23-2	405.00	1534-30-2	393.00	1534-37-2	476.00
	60"	1527-68-2	521.00	1527-75-2	467.00	1527-82-2	610.00	1534-24-2	476.00	1534-31-2	425.00	1534-38-2	554.00
	72"	1527-69-2	618.00	1527-76-2	504.00	1527-83-2	663.00	1534-25-2	561.00	1534-32-2	459.00	1534-39-2	604.00
	84"	1527-70-2	753.00	1527-77-2	574.00	1527-84-2	876.00	1534-26-2	683.00	1534-33-2	521.00	1534-40-2	796.00
	96"	1527-71-2	796.00	1527-78-2	839.00	1527-85-2	982.00	1534-27-2	725.00	1534-34-2	764.00	1534-41-2	891.00

Price includes mounting at height specified.

# CLEANROOM WORK STATIONS



*Stainless steel C-Base bench  
(No. 1521-55) and optional drawer unit*



*Static-dissipative C-Base Bench No. 1521-32, with  
No. 1524-50 uprights, 1700-76 light, 1700-90 shelf and 1740-07 drawer.*

## Stainless Steel Tops

- Stainless steel work surface meets ISO 5 particle requirements
- Choice of adjustable "A" base or nonadjustable "C" base available in either finished steel or stainless steel
- Ground terminals and wrist-strap pin connectors allow easy grounding of ionizing guns, wrist straps, and other static protection equipment



### IonBar™ (with fan module)

Projects a balanced stream of positive ions for neutralization of static charges throughout a restricted area. Requires shelf and shelf support for fixed installation. Can be used with any Terra bench.

	Cat. #	\$/Each
22" Long	2005-30	900.00
33" Long	2005-32	1,016.00
44" Long	2005-31	1,133.00

## Laminate Tops

- Sealed laminate top design meets ISO 5 particle requirements
- Static-dissipative laminate (10<sup>6</sup> to 10<sup>8</sup> ohms/sq.) safely dissipates charges to reduce possibility of electro-static discharge (meets MIL-B-81705-B specifications)
- Select adjustable "A" base or recessed "C" base to suit your application requirements
- Optional modular overhead fluorescent light fixture provides shadow-free viewing anywhere on benchtop surface
- Optional ionizing fan provides safe, reliable, static neutralization



## Call For Current Pricing

Benchtop Dimens. (W" x D")	304 Stainless Steel Top w/ Finished Steel Base*				Laminate Tops			
	Solid Top		Perforated Top (.75" ID Hole)**		Nonconductive Tops		Static Dissipative Tops	
	"A" Base Design (telescoping legs)	"C" Base Design (recessed legs)	"A" Base Design (telescoping legs)	"C" Base Design (recessed legs)	"A" Base Design (telescoping legs)	"C" Base Design (recessed legs)	"A" Base Design (telescoping legs)	"C" Base Design (recessed legs)
	Cat. #	Cat. #	Cat. #	Cat. #	Cat. #	Cat. #	Cat. #	Cat. #
48 x 30	1521-45	1521-54	1522-56A	1522-66A	1722-00	1521-09	1728-00	1521-31
60 x 30	1751-00	1521-55	1522-57A	1522-67A	1724-00	1000-00	1730-00	1521-32
72 x 30	1752-00	1521-56	1522-58A	1522-68A	1726-00	1000-01	1732-00	1521-33
84 x 30	1521-46	1521-57	1522-59A	1522-69A	1521-01	1000-02	1521-23	1521-34
96 x 30	1753-00	1521-58	1522-60A	1522-70A	2402-00	1000-03	2400-00	1521-35
48 x 34	1521-49	1521-61	1522-61A	1522-71A	1723-00	1521-16	1700-29	1521-38
60 x 34	1700-65	1521-62	1522-62A	1522-72A	1725-00	1521-17	1731-00	1521-39
72 x 34	1700-66	1521-63	1522-63A	1522-73A	1727-00	1521-18	1733-00	1521-40
84 x 34	1521-50	1521-64	1522-64A	1522-74A	1521-05	1521-19	1521-27	1521-41
96 x 34	1521-51	1521-65	1522-65A	1522-75A	1521-06	1521-20	1521-28	1521-42

\* Stainless Steel Scuff Guards included on finished C-Base benches; order separately for A-Bases. Nonadjustable (one piece) legs also available with "A" Base design at no additional cost (specify when ordering). Finish is white powder coat.

\*\* For 0.25" diameter perforations, add \$32/ft. of width to the standard pricing.



A-Base Bench No. 1522-01, shown with optional drawers

## Chemical-Resistant Tops

- Lightweight polypropylene work surface provides optimal protection against acids and other caustic chemicals
- Cleanroom-compatible design meets ISO 5 particle requirements
- Perforated top with plenum chamber available for venting fumes during wet processing operations
- Raised "ship's edges" available to contain dangerous spills
- Modular overhead fixture houses three-position fluorescent light (order separately)

### Base Styles:



Telescoping  
"A" Base -  
Adjustable 25"-  
34"H

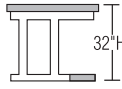

32"H  
Recessed  
"C" Base



## Stainless Steel Leg Member

Replaces lower leg of A-Base benches to guard against scuffs.

Cat. # S/Each  
1741-25 32.00

## Cleanroom Drawers

No. of Drawers	Min. Drawer Height	ABS Plastic (14 1/2"W x 15 1/4"D)		304 Stainless Steel (16"W x 18"D)	
		Cat. #	S/Each	Cat. #	S/Each
1	3"	1740-23	212.00	—	—
1	6"	1740-02	221.00	1741-20	226.00
1	12"	1740-98	312.00	1741-21	351.00
2	3", 6"	1740-14	385.00	—	—
2	6", 6"	1740-15	399.00	1741-22	450.00
2	6", 12"	1740-06	440.00	1741-23	626.00
3	3", 6", 12"	1740-07	628.00	—	—
3	6", 6", 6"	1740-09	575.00	1741-24	772.00

## Shelf and Light Supports

Material	For Light/Shelf (36")		For Shelf Only (18")	
	Cat. #	S/Pair	Cat. #	S/Pair
Stainless Steel	1525-68	293.00	1525-69	216.00
Powder-Coated Steel	1524-50	138.00	1524-51	109.00

Benchtop Dimens. (W" x D")	Polypropylene Tops			Corresponding Accessories							
	Polypropylene Solid Top			Fluorescent Light Fixtures (finished steel)	304 Stainless Steel Shelf (12" X 1.25") (Fits on either upright)		Nonconductive Shelf (12" X 1.25") (Fits on either upright)		Static-Dissipative Shelf (12" X 1.25") (Fits on either upright)		
	"A" Base Design (telescoping legs)	"C" Base Design (recessed legs)	S/Each		Cat. #	S/Each	Cat. #	S/Each	Cat. #	S/Each	
48 x 30	1522-00	1522-14	894.00	1524-78	601.00	1525-26	603.00	1527-07	139.00	1524-80	252.00
60 x 30	1522-01	1522-15	929.00	1700-76	654.00	1525-27	639.00	1000-65	142.00	1700-90	258.00
72 x 30	1522-02	1522-16	951.00	1700-78	704.00	1525-28	671.00	1000-66	151.00	1700-92	279.00
84 x 30	1522-03	1522-17	958.00	1527-00	737.00	1525-29	688.00	1000-67	158.00	1527-35	287.00
96 x 30	1522-04	1522-18	1,177.00	1700-80	769.00	1525-30	715.00	1000-68	166.00	1700-94	300.00
48 x 34	1522-07	1522-21	929.00	1524-78	601.00	1525-26	603.00	1527-07	139.00	1524-80	252.00
60 x 34	1522-08	1522-22	989.00	1700-76	654.00	1525-27	639.00	1000-65	142.00	1700-90	258.00
72 x 34	1522-09	1522-23	999.00	1700-78	704.00	1525-28	671.00	1000-66	151.00	1700-92	279.00
84 x 34	1522-10	1522-24	1,065.00	1527-00	737.00	1525-29	688.00	1000-67	158.00	1527-35	287.00
96 x 34	1522-11	1522-25	1,219.00	1700-80	796.00	1525-30	715.00	1000-68	166.00	1700-94	300.00

## Tables and work stations for every requirement, in stock for immediate shipping

- Auto-adjusting ErgoHeight™
- Epoxy-resin and Corian® lab tables
- Back-splash work stations
- Down-draft fume removal stations
- Electrical benches



ErgoHeight™ Auto-Adjusting Table No. 3504-90



Epoxy-resin Table No. 2903-10

# LAB AIDS



Item	Dimensions W" x D" x H"	Acrylic		Static Dissipative PVC		Polypropylene	
		Cat. #	S/Each	Cat. #	S/Each	Cat. #	S/Each
A. Sneeze Guard	7.125 x 1.75 x 7.75	1601-50	17.00	1601-51	27.00	—	—
Sneeze Guard	11 x 1.625 x 11	1600-25	20.00	1602-75	30.00	—	—
B. Dispensing Bin	5 x 8 x 11.65	4950-12	156.00	4950-13	272.00	4952-06	271.00
C. Mini-Hood	20 x 12 x 16	4950-89	450.00	4950-90	728.00	4952-00	726.00
D. Balance Shield	12.25 x 13 x 12	4950-55	202.00	4950-56	291.00	—	—
E. Micro-Desiccator Storage Cabinet	9 x 11 x 8.5	4950-06	485.00	4950-08	738.00	4952-01	704.00
F. Tissue Box Holder	5.5 x 5.75 x 3.125	4950-41	20.00	4950-42	29.00	—	—
F. Tissue Box Holder	5 x 5.125 x 4.125	4005-53	29.00	4005-54	36.00	—	—
F. Tissue Box Holder	5.5 x 15 x 4.25	4950-43	42.00	4950-44	50.00	—	—
G. Pigeon-Hole Organizer	16 x 16 x 7.5	4005-22	149.00	—	—	—	—
H. Safety Glasses Dispenser	6.75 x 5.75 x 17	4950-45A	269.00	4950-46	391.00	4952-10A	391.00
I. Clip Board, Electropolished SS	12 x 9.5	1350-00A-2	62.00	—	—	—	—

# STAINLESS STEEL GLOVE DISPENSERS



**A** Models for loose or packaged gloves



**B**



**C**

**G**

**F**

## Stainless Steel Glove Dispensers –Electropolished 304 (316 SS available) by Terra

	Description	Dimensions W" x D" x H"	Cat. #	S/Each
<b>A</b>	Glove Dispenser Wall-mount	8 x 8 x 24 (1 Compartment)	4951-37-2	507.00
	Glove Dispenser Wall-mount	16 x 8 x 24 (2 Compartments)	4951-38-2	1,020.00
	Glove Dispenser Wall-mount	24 x 8 x 24 (3 Compartments)	4951-32-2	1,283.00
	Glove Dispenser Wall-mount	34.5 x 8 x 24 (4 Compartments)	4951-33-2	1,632.00
<b>B</b>	Bagged Gloves Dispenser Wall-mount	24.5 x 7.5 x 24 (2 Compartments)	4951-43-2	999.00
	Bagged Gloves Dispenser Wall-mount	34.5 x 7.25 x 24 (3 Compartments)	4951-44-2	1,242.00
	Bagged Gloves Dispenser Wall-mount	27 x 7 x 24 (3 Compartments)	4951-30-2	1,235.00
	Bagged Gloves Dispenser Wall-mount	34.5 x 8 x 24 (4 Compartments)	4951-31-2	1,559.00
<b>C</b>	Bagged Gloves Dispenser Wall-mount	27 x 8.25 x 24.9 (4 Compartments)	4951-46-2	1,563.00
	Glove Dispenser with Waste Bin	24 x 18.5 x 59 (3 Compartments)	4951-34-2	2,558.00
	Glove Dispenser with Waste Bin	31.5 x 18.5 x 63 (4 Compartments)	4951-39-2	3,104.00
<b>D</b>	Glove Dispenser (not shown)	12 x 6 x 6	4951-50-2	145.00
<b>E</b>	Glove Dispenser (not shown)	5.75 x 3.875 x 11 (1 box)	4951-53-2	63.00
<b>F</b>	Glove Dispenser	12 x 3.75 x 11 (2 boxes)	4951-54-2	69.00
<b>G</b>	Glove Dispenser	18 x 3.75 x 11 (3 boxes)	4951-55-2	92.00
<b>H</b>	Glove Dispenser (not shown)	5.75 x 3.875 x 22 (2 boxes)	4951-51-2	70.00
<b>I</b>	Glove Dispenser (not shown)	5.75 x 3.875 x 33 (3 boxes)	4951-52-2	82.00



**A**

Benchtop option for item A, No. 4951-90-2

# PLASTIC GLOVE DISPENSERS



**A** Polypropylene



**B**



**C**



**D**

Polypropylene

## Acrylic, Static Dissipative PVC and Polypropylene Glove Dispensers by Terra

Glove Dispenser	Dimensions W" x D" x H"	Acrylic		Static Dissipative PVC		Polypropylene	
		Cat. #	S/Each	Cat. #	S/Each	Cat. #	S/Each
<b>A</b> Wall Mount (3 Chamber)	16 x 11.5 x 12	4005-56	300.00	4005-57	454.00	4952-03	495.00
<b>B</b> Wall Mount	16.5 x 12.5 x 17	4950-72	270.00	4950-74	364.00	4952-02	401.00
<b>C</b> Plastic Boxed Gloves Holder	5.125 x 11.5 x 4.88	4950-85	59.00	4950-86	98.00	—	—
<b>D</b> Benchtop	12 x 6 x 6	4951-03	93.00	4951-04	141.00	4952-04	140.00



No. 6705-26C Stainless Steel Pass-Through



No. 1993-12C Acrylic Pass-Through



No. 1992-86C Stainless Steel Floor-Mount Pass-Through

## CLEANROOM PASS-THROUGH CHAMBERS

- Allows contamination-free transfer of materials in and out of the cleanroom or laboratory
- Stainless steel-reinforced doors extend the service life of chambers
- Foolproof interlock mechanism prevents cross contamination
- Dozens of standard sizes and configurations:

Standard Chambers: below

Modular Cleanroom Chambers: page 48

Cleanroom Talk-Through: page 48

BioSafe+® Chambers: page 50

Roll-Up Door Chambers: page 52

Fire-Rated Chambers: page 53

Ruggedized Chambers: page 53

Air Showers: page 54



Now with all-stainless steel LiftLatches™ for cleaner operation

### FirmLok™ Interlock (included)

Terra's FirmLok prevents cross-contamination by ensuring that only one pass-through door at a time can open.

The moment a door is opened, the latch engages a stainless steel catch to lock out the opposing door. The highly reliable interlock design is rated for thousands of trouble-free operations.

The dual heavy-gauge latch mechanisms retract inside the easy-clean stainless steel housing when not engaged.

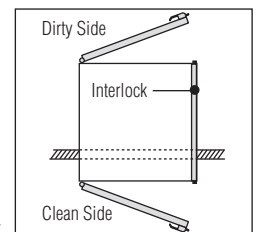

Standard Installation: Mechanical interlock requires that both doors close on the same sidewall

### Pass-Through Chambers (Doors are made of material indicated in parentheses; other designs available.)

Mount Type	W" x D" x H" Add .5" to W x H for cut-out)	304 Stainless Steel Noncontinuous Seams (Stainless Steel Doors/ Dissipative PVC Windows)		304 Stainless Steel CleanSeam+™ (2) Continuous Seam (Stainless Steel Doors/ Dissipative PVC Windows)		Powder-Coated Steel (Powder-Coat Doors/ Dissipative PVC Windows)		Polypropylene (Nondissipative PVC Doors)		Static Dissipative PVC (Dissipative PVC Doors)		Acrylic Do not clean with alcohol	
		Cat. #	\$/Each	Cat. #	\$/Each	Cat. #	\$/Each	Cat. #	\$/Each	Cat. #	\$/Each	Cat. #	\$/Each
Wall	12 x 12 x 12	1992-09D	3,091.00	2638-70A-2	4,842.00	1991-00D	1,901.00	1992-26D	1,920.00	1992-37D	1,895.00	1993-12D	1,621.00
	12 x 12 x 24	1992-10D	3,468.00	2638-71B-2	6,344.00	1992-18D	2,244.00	1992-27D	2,108.00	1992-38D	2,307.00	1948-20D	1,839.00
	18 x 18 x 16	1992-11D	3,905.00	2638-72B-2	7,141.00	1992-00D	2,720.00	1992-28D	2,481.00	1992-39D	2,630.00	1992-48D	2,001.00
	18 x 18 x 24	1992-12D	4,040.00	2638-73B-2	7,554.00	1992-19D	2,842.00	1992-29D	2,701.00	1992-40D	2,866.00	1992-49D	2,155.00
	24 x 24 x 16	1992-13D	4,706.00	2638-74B-2	8,328.00	1993-00D	2,974.00	1992-30D	2,849.00	1992-41D	3,083.00	1992-50D	2,352.00
	24 x 24 x 24	1992-14D	5,439.00	2638-75B-2	9,830.00	1992-20D	3,125.00	1992-31D	3,101.00	1992-42D	3,320.00	1992-51D	2,539.00
	24 x 36 x 24	1992-15D	6,095.00	2638-76B-2	10,119.00	1992-21D	3,401.00	1992-32D	3,437.00	1992-43D	3,892.00	1992-44D	3,217.00
	24 x 24 x 48	6705-26D	5,901.00	2638-77B-2	13,155.00	6705-27D	3,125.00	6705-28D	3,416.00	—	—	6705-29D	3,237.00
	36 x 36 x 24	1997-03D	6,141.00	2638-78B-2	11,076.00	1992-22D	3,532.00	1992-33D	3,582.00	—	—	1992-52D	3,363.00
	24 x 24 x 36	1992-16D	6,311.00	2638-79B-2	11,928.00	1992-23D	3,321.00	1992-34D	3,375.00	1992-45D	3,825.00	1992-46D	3,154.00
Floor (1)	36 x 36 x 36	1997-06D	6,618.00	2638-80B-2	14,264.00	1992-24D	3,582.00	1992-35D	3,780.00	—	—	1992-53D	3,769.00
	36 x 36 x 48	1997-08D	7,068.00	2638-81B-2	15,349.00	1992-25D	3,934.00	1992-36D	3,954.00	—	—	1992-80D	3,626.00
	24 x 24 x 36	1992-84D	5,914.00	2638-82B-2	12,380.00	1993-01D	3,574.00	1993-04D	3,720.00	1993-07D	5,741.00	1993-08D	3,536.00
	36 x 36 x 36	1992-85D	7,504.00	2638-83B-2	14,995.00	1993-02D	3,875.00	1993-05D	3,997.00	—	—	1993-09D	3,813.00
	36 x 36 x 48	1992-86D	7,951.00	2638-84B-2	17,168.00	1993-03D	4,223.00	1993-06D	4,516.00	—	—	1993-10D	4,332.00

(1) Floor-Mount models include low-profile access ramps for easy transport of carts (subtract 1" from internal vertical clearance to compensate for ramps).

(2) See description on page 47

# CLEANSEAM+™ STAINLESS STEEL PASS-THROUGHS

- Easy-mount system allows installation within 3 minutes without any exposed hardware
- Flush-mount bracket leaves no cracks or crevices on "clean"-side wall for easy cleaning and sterilizing – ideal for aseptic facilities
- Unique folded design features rounded internal corners to support sterile processes
- Electropolished 304/316 stainless steel creates ultra-smooth, ultra-clean surfaces
- Stainless steel latches use a lifting design that eliminates scraping and contamination
- Interlock rated for millions of operations

The CleanSeam+ provides the optimal transfer chamber for the broadest range of critical applications, including ISO 3-8 cleanliness requirements and sterile processing. See ordering information on page 46.



## Fluorescent Illuminator

For models up to 18"W  
For models over 18"W

Cat. #	S/Each
1993-33	270.00
1993-34	377.00

## Other Options

ULPA Air Showers	See page 49
Ventilation Modules	See page 49
CleanTop Sloped Top	See page 49
Germicidal UV Lighting	See page 48
Talk-Through Ports	See page 48
Self-Closing Hinges	See page 49

## Grounding Terminals

Recommended on steel and dissipative PVC chambers.

1686-12	80.00
---------	-------

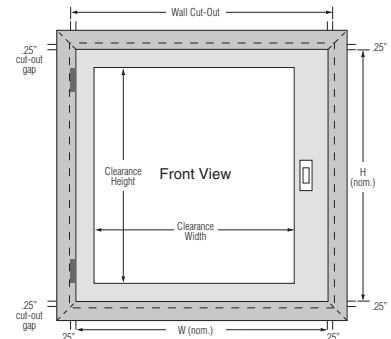

## Access Clearances

Width = W (nominal) – 1.88"  
Depth = D (nominal)\* – 0.12"  
Height = H (nominal) – 1.25"

## Wall Cut-Out

W (nominal) + 0.5" x H (nominal) + 0.5"

\* Subtract 0.5" for plastic chambers. Each door adds 0.5" to nominal depth.

## CleanSeam+ Pass-Throughs with Isolated Interlock

This configuration isolates the interlock outside the transfer chamber to optimize cleanliness—ideal for aseptic operations that won't tolerate germ traps! Interlock mechanism slides out for easy access. **Smart Pass-Through** module allows additional digital function, See page 48.

**Call to discuss your requirements!**

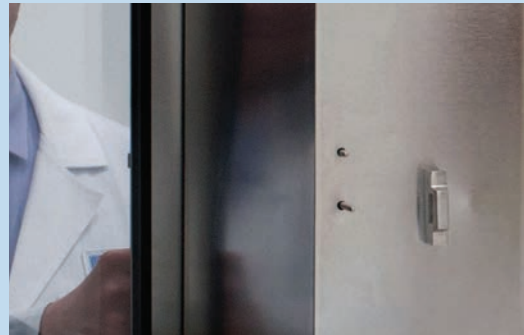

## Corresponding Pass-Through Accessories — for Pass-Through Chambers on facing page.

W" x D" x H" Add .5" to W x H for cut-out)	FirmLok™ Mechanical Interlocks (Replacement)		Stainless Steel Shield <sup>(3)</sup>		Stainless Steel Shelf		Stainless Steel Rack	
	Cat. #	S/Each	Cat. #	S/Each	Cat. #	S/Each	Cat. #	S/Each
12 x 12 x 12	6705-50A	612.00	1992-65A	226.00	1992-70A	226.00	1993-40A	668.00
12 x 12 x 24	6705-50A	612.00	1992-65A	226.00	1992-70A	226.00	1993-41A	752.00
18 x 18 x 16	6705-51A	689.00	1992-66A	244.00	1992-71A	244.00	1993-42A	730.00
18 x 18 x 24	6705-51A	689.00	1992-66A	244.00	1992-71A	244.00	1993-43A	848.00
24 x 24 x 16	6705-52A	765.00	1992-67A	284.00	1992-72A	284.00	1993-44A	850.00
24 x 24 x 24	6705-52A	765.00	1992-67A	284.00	1992-72A	284.00	1993-45A	907.00
24 x 36 x 24	6705-53A	919.00	1992-68A	384.00	1992-73A	384.00	1993-46A	960.00
24 x 24 x 48	6705-52A	765.00	1992-67A	284.00	1992-72A	284.00	1993-48A	1,178.00
36 x 36 x 24	6705-53A	919.00	1992-69A	536.00	1993-28A	—	1993-47A	934.00
24 x 24 x 36	6705-52A	765.00	1992-67A	284.00	1992-72A	284.00	1993-49A	—
36 x 36 x 36	6705-53A	919.00	1992-69A	536.00	1993-28A	—	1993-49A	—
36 x 36 x 48	6705-53A	919.00	1992-69A	536.00	1993-28A	—	1993-50A	1,258.00
24 x 24 x 36	6705-52A	765.00	1992-67A	284.00	1992-72A	284.00	1993-51A	—
36 x 36 x 36	6705-53A	919.00	1992-69A	536.00	1993-28A	—	1993-52A	—
36 x 36 x 48	6705-53A	919.00	1992-69A	536.00	1993-28A	—	1993-53A	—

<sup>(3)</sup> Shields are recommended in all plastic pass-throughs to prevent scratching. Racks allow adjustable shelf placement and are required for use with shelves.

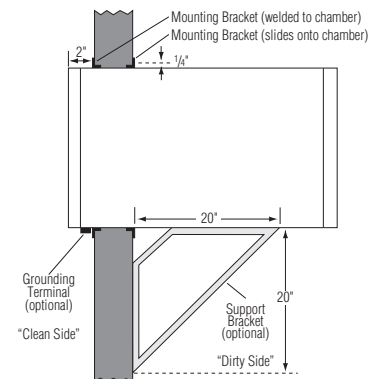

## Support Brace

	Cat. #	S/Each
Powder-Coat Steel	1993-83C	295.00
Stainless Steel	1993-60C	307.00

# SMART PASS-THROUGH™ CHAMBER



First-of-its-kind Smart Pass-Through with electronic interlock monitors "blind-side" conditions, issues service alerts, and manages pass-through accessories, such as Air Shower, UV Sanitizing Module, or Access Data Logging.

*Flush-mount design includes status alert logos: solid glow indicates chamber ready to access; slow flash indicates interlock is active; rapid flash after 20 seconds indicates door left ajar*

- Provides audible and visible alerts when interlock is active or door is left ajar to prevent forcing and potentially damaging locked doors
- Signals when chamber is ready to load or unload with a continuous door alert light
- Flush-mount design eliminates surfaces on "clean side" that collect germs and other contaminants
- Easy installation allows the pass-through to be conveniently removed for servicing or upgrade without compromising the cleanroom environment - adjusts to any wall thickness >2"
- Double-wall construction isolates the electronic interlock outside the transfer chamber for easy cleaning and sterilization of chamber interior
- Electromagnetic interlock isolated outside transfer chamber for easy cleaning
- Provides power integration of all selected options: UV light, air shower, data logging, biometric security features and more
- Includes two plug-in chimes for remote audible detection – up to 200 feet away – of door open/ajar status

Dozens of standard configurations – visit [TerraUniversal.com](http://TerraUniversal.com) for complete ordering information. Options include

- Automatic Doors
- UV-C Light
- Micro-Filtered Air Shower
- Recessed LED Light
- Message Panel
- Biometric/Keypad Door Control
- Remote Wireless Door Control
- Bar Code Scanner
- Local/Remote Datalogging
- Pushbutton Intercom
- Load Pressure Sensor
- Door Status Display Bar
- Internal Video Camera
- Refrigeration Module
- Adjacent-Wall Access Doors
- Removable Racks and Shelves
- Ventilation Module
- More!



*Optional Automatic door allows hands-free operation*

## VALULINE™ PASS-THROUGH



- Economical chambers enhance operational cleanliness by eliminating the need for garbed personnel to transfer parts into and out of the lab or cleanroom
- Seven wall-mount sizes accommodate materials up to 22" x 22" x 24"
- Transparent windows allow full visibility of chamber interior.

Choose between two materials: chemical-resistant polypropylene includes static-dissipative PVC viewing windows for compatibility with most cleaning agents, including alcohol; black acrylic includes clear acrylic windows. Both models feature a stainless steel protective shield on the chamber floor to resist scratches and prolong chamber service life.

*Model shown: 12" x 12" x 12" polypropylene, No. 2634-01 (\$872)  
Dozens of Models available at [TerraUniversal.com](http://TerraUniversal.com)*



# PASS-THROUGH CHAMBER ACCESSORIES

**QuickQuote Planner**  
quickly configures a system to your specifications: [www.TerraUniversal.com](http://www.TerraUniversal.com)



## Ventilation System

Designed for stainless steel pass-throughs, this system removes solvents and other hazardous vapors from materials while they are in the pass-through. System components (flange and filter) must be ordered together with the pass-through. Active ventilation system, with onboard ventilation blower, also available; call to discuss your application.

**Stainless Steel Flange** Cat. # S/Each  
6"-diameter x 3"; connects to in-house ventilation system **6705-23 282.00**

**Inlet ULPA Filter** Cat. # S/Each  
Removes particles from make-up air. Includes 99.999% efficient ULPA filter and 304 SS filter housing, installed to side of pass-through (specify desired location). **6705-24 269.00**

## ULPA Filtered Air Shower

Fits on top of any Terra Pass-Through 18"D or larger. Includes ON/OFF status light and door sensor switch (for connection to "dirty" side access door).

Standard housing material is 304 stainless steel; other materials are also available. Price includes installation on specified pass-through chamber.

Cat. # S/Each  
**1993-11A 1,892.00**



## CleanTop 304 Stainless Steel Sloping Top

In most applications, pass-throughs extend only 2" into a cleanroom to minimize clearance requirements and surfaces that could collect particles. The CleanTop is designed for installations that require the chamber to be centered in the wall. The 30° sloping top on clean room side minimizes particles and accommodates laminar flow.

Available for stainless steel pass-throughs of 18", 24" and 36" overall depth. Price is for CleanTop feature only; order Pass-Through Chamber separately. Both must be specified on the same order (CleanTop cannot be retrofitted).

CleanTop™ 304 Stainless Steel Sloping Top			
Pass-Through Dimensions	CleanTop Dimensions	304 Stainless Steel* Cat. #	S/Each
18"W x 18"D	18"W x 6"D	<b>6705-15</b>	<b>268.00</b>
24"W x 24"D	24"W x 10"D	<b>6705-16</b>	<b>336.00</b>
36"W x 24"D	36"W x 10"D	<b>6705-17</b>	<b>431.00</b>
36"W x 36"D	36"W x 16"D	<b>6705-18</b>	<b>536.00</b>

\* Electropolished and powder-coated models available; see [TerraUniversal.com](http://TerraUniversal.com).



## Sprinkler Module

Installed inside the pass-through for safe operation with flammable materials.

Cat. # S/Each  
**1993-30 476.00**

## Spring-Loaded Hinge

Use in conjunction with electronic door to ensure hand-free door closure. Call for quotation.

Cat. # **6705-14**



## Electronic Door Opener

Avoid spills or other accidents that result when both hands are full! This foot pedal-activated door also reduces contamination by eliminating repeated hand-to-door contact. The non-contaminating door mechanism opens and closes the door with a slow, controlled motion.

Cat. # **6705-80**

**Call to discuss your application.**

# BIOSAFE® + PASS-THROUGH CHAMBERS

Now with all-304/316 stainless steel latches to eliminate scratching, corrosion and contamination common with plated hardware.



- **Flush-Mount Design** — one-piece integral bracket eliminates hardware and cracks that harbor germs
- **Seamless** — Unique design eliminates cracks, corners and other contaminant traps!
- **Lipless** — Easy material transfer with no clearance obstruction
- **Easy to Clean** — Ultra-smooth internal surfaces
- **Easy to Sterilize** — 304/316 SS; removable doors can be autoclaved
- **Double-Wall, Sealed Construction** — adds rigidity and houses interlock and standard or custom utilities without compromising the ultra-clean design
- **Two Minutes to Install!** — View the video at [TerraUniversal.com](http://TerraUniversal.com)



Removable doors are available with and without windows, suitable for steam sterilization

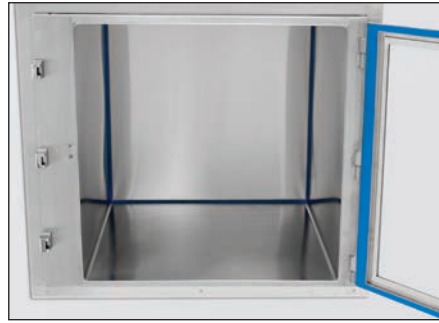

No-lip, smooth chamber interior features radius corners for easy cleaning and disinfection



BioSeal™ edge seals against non-contaminating, chemically resistant polyurethane set in doors

**BioSafe® + Stainless Steel Pass-Through Chambers — Optimized for Aseptic Biological and Pharmaceutical Requirements**

These unique Pass-Throughs feature all-continuous-seam welds with radius corners to produce ultra-clean, smooth internal surfaces that wipe down quickly and easily. Their no-lip design eliminates clearance restrictions and gives you full use of the chamber interior. This design simplifies the transfer of materials into and out of the cleanroom or laboratory.

All components of these chambers have been engineered to optimize cleanliness and simplify disinfection. The doors feature inset polyurethane, a durable, chemically resistant, non-contaminating elastomer, which seals against the raised edge along the chamber perimeter. This bioseal eliminates the need for adhesive gaskets that can creep, crack and outgas. Chambers come with safety-glass windowed doors (solid doors available). Both styles can be easily removed after pass-through installation, allowing you to interchange models. They are also designed to be steam sterilized to help maintain an aseptic environment.

**Unique Pass-Through Interlock Eliminates Cross-Contamination**

The rugged interlock mechanism prevents the handle and latch of either door from moving when the opposing door is open, protecting your cleanroom or laboratory from contamination during material transfer. The rugged latch pins ensure that an interlocked door cannot be forced open. The isolated interlock design further optimizes cleanliness. Because the mechanism is mounted in its own, narrow-profile housing, the inside of the pass-through chamber itself remains unobstructed and easy to sterilize.

All models include a flush-mount integral bracket that secures the unit snugly against the "clean"-side wall to eliminate fasteners and cracks that harbor contaminants. The opposing side features a one-piece bracket and bracket cover that leaves a smooth surface. The unique mounting system allows 2-minute installation. This design accommodates walls of varying thicknesses.

BioSafe+ 304/316 Stainless Steel Pass-Throughs <sup>(1)</sup> (include windowed doors (order solid doors below)						Corresponding Accessories			
Outside Dimensions W" x D" x H" (Add .5" to W x H for cut-out) Doors add 1" to depth	Inside Dimensions W" x D" x H"	Electropolished 304 Stainless Steel		Electropolished 316 Stainless Steel		Removable Racks 304 Electropolished Stainless Steel		304 Electropolished Stainless Steel Shelf (order rack separately)	
		Cat. #	\$/Each	Cat. #	\$/Each	Cat. #	\$/Each	Cat. #	\$/Each
17.5 x 12 x 13.6	12 x 12 x 12	2636-59C-2	9,394.00	2636-74C-2	10,071.00	2638-50-2	334.00	2638-60-2	260.00
17.5 x 12 x 25.6	12 x 12 x 24	2636-60C-2	10,228.00	2636-75C-2	11,337.00	2638-51-2	376.00	2638-60-2	260.00
23.5 x 18 x 17.6	18 x 18 x 16	2636-61C-2	11,560.00	2636-76C-2	13,107.00	2638-52-2	365.00	2638-61-2	318.00
23.5 x 18 x 25.6	18 x 18 x 24	2636-62C-2	12,184.00	2636-77C-2	14,189.00	2638-53-2	424.00	2638-61-2	318.00
29.5 x 24 x 17.6	24 x 24 x 16	2636-63C-2	12,830.00	2636-78C-2	14,271.00	2638-54-2	400.00	2638-62-2	342.00
29.5 x 24 x 25.6	24 x 24 x 24	2636-64C-2	13,703.00	2636-79C-2	15,211.00	2638-55-2	432.00	2638-62-2	342.00
29.5 x 36 x 25.6	24 x 36 x 24	2636-65C-2	19,957.00	2636-80C-2	22,301.00	2638-56-2	480.00	2638-63-2	376.00
29.5 x 24 x 37.6	24 x 24 x 36	2636-67C-2	20,182.00	2636-82C-2	22,361.00	2638-57-2	467.00	2638-62-2	342.00
33 x 24 x 51.6	27.5 x 24 x 50	2636-84C-2	21,488.00	2636-85C-2	22,836.00	2638-58-2	589.00	2638-64-2	357.00

<sup>(1)</sup> Mounting brackets (included) are made of stainless steel. Wall cut-out should be 2" wider and 1" taller than the chamber.

Outside Dimensions W" x D" x H"	Corresponding Stainless Steel Doors (order one for each side)							
	Solid Doors (no windows)				Doors with Tempered Glass Windows			
	304 SS		316 SS		304 SS		316 SS	
	Cat. #	\$/Each	Cat. #	\$/Each	Cat. #	\$/Each	Cat. #	\$/Each
17.5 x 12 x 13.6	2638-00-2	208.00	2638-10-2	292.00	2638-20-2	417.00	2638-30-2	501.00
17.5 x 12 x 25.6	2638-01-2	278.00	2638-11-2	390.00	2638-21-2	486.00	2638-31-2	597.00
23.5 x 18 x 17.6	2638-02-2	264.00	2638-12-2	370.00	2638-22-2	471.00	2638-32-2	578.00
23.5 x 18 x 25.6	2638-03-2	306.00	2638-13-2	428.00	2638-23-2	513.00	2638-33-2	637.00
29.5 x 24 x 17.6	2638-04-2	292.00	2638-14-2	410.00	2638-24-2	501.00	2638-34-2	617.00
29.5 x 24 x 25.6	2638-05-2	333.00	2638-15-2	466.00	2638-25-2	542.00	2638-35-2	675.00
29.5 x 36 x 25.6	2638-05-2	333.00	2638-15-2	466.00	2638-25-2	542.00	2638-35-2	675.00
29.5 x 24 x 37.6	2638-07-2	444.00	2638-17-2	623.00	2638-27-2	653.00	2638-37-2	832.00
23 x 24 x 51.6	2638-39-2	444.00	2638-40-2	623.00	2638-41-2	653.00	2638-42-2	832.00



Optional removable rack and shelves

**Mounting Brace**

Installed on the "dirty" side wall to support 36"-deep chambers (two recommended).

Cat. #	\$/Each
1993-60B	292.00



Select Models



No. 6705-30C (Shown with BioSafe Cleanroom Ladder)



No. 6705-12A



No. 6705-13A

# ROLL-UP DOOR PASS-THROUGHS

This unique, space-saving pass-through features dual-side segmented doors that automatically roll up and down at the push of a PLC control pad. This design eliminates door clearance requirements and makes it easy for gloved personnel to operate while holding parts. Motorized lifters are sealed inside a noncontaminating housing.

Dimensions		Floor Mount (Includes Ramps) <sup>(1)</sup>		Corresponding Air Shower	
Outside W" x D" x H"	Inside W" x D" x H"	Cat. #	\$/Each	Cat. #	\$/Each
44 x 30 x 61.5 Excluding Hardware	29 x 28 x 44	<b>6705-12C</b>	<b>12,875.00</b>	<b>6705-12C-AS</b>	<b>22,019.00</b>
63.5 x 50 x 87	52.75 x 48 x 66.25	<b>6705-10C</b>	<b>19,434.00</b>	<b>6705-10C-AS</b>	<b>21,653.00</b>
82.5 x 50 x 78.75	68 x 48 x 61.25	<b>6705-13C</b>	<b>22,019.00</b>	<b>6705-13C-AS</b>	<b>24,383.00</b>

<sup>(1)</sup> Includes mounting brackets made of stainless steel. All brackets require 0.5" clearance between wall cutout and pass-through. Standard mounting is 2" from the front of the cleanroom side (specify other desired location). Bracket on cleanroom side is welded in place; remaining bracket attaches to opposing side of wall.



# PASS-THROUGH AIR SHOWER

These Pass-Through Air Showers offer an effective way to remove surface-deposited particles on carts as you transfer them into the clean room. Adjustable nozzles provide concentrated streams of high-velocity HEPA-filtered air that lifts off contaminants, which are purged through vents along the bottom of the chamber. Nozzles are arranged uniformly on walls to ensure effective distribution of filtered air.

The closed-loop circulation design directs contaminated air downward through grills and hollow walls of the Air Shower and back to the filter, which removes 99.99% of all particles as small as 0.3 microns. Interlocking doors prevent unnecessary contamination inflow and thereby prevent cross-contamination of the cleanroom. They automatically release in the event of a power failure.

Chamber Dimensions: 36"W x 36"D x 48"H (custom sizes available)

Air Shower Pass-Through	Powder-Coated Steel		304 Stainless Steel	
	Cat. #	\$/Each	Cat. #	\$/Each
120VAC	<b>6705-70</b>	<b>11,191.00</b>	<b>6705-71</b>	<b>17,788.00</b>
220VAC	<b>6705-70-220</b>	<b>11,191.00</b>	<b>6705-71-220</b>	<b>17,788.00</b>

# FIRE-RATED PASS-THROUGH CHAMBERS



- Fire-rated access panels carry the UL-B label for 90-minute fire exposure (suitable for 2-hour wall rating)
- Heavy-duty, double-wall door construction prevents chamber misalignment and door damage when operators apply excessive force to an interlocked door
- Recessed pull-to-open latch withstands up to 50 lbs. of force without damaging the catch, interlock, or door frame
- Includes fire-rated wired-glass viewing windows
- Spring-action, self-closing doors simplify operation, minimize the chance of contamination

These pass-through chambers are designed for installation in a fire-rated cleanroom or laboratory wall. They allow transfer of materials into and out of the controlled environment, and their rugged interlock mechanism offers high reliability with no maintenance.

## Fire-Rated Access Doors

Each chamber features dual 2.5" (64 mm)-thick, insulated electropolished 304 stainless steel access panels (doors), each with a recessed pull latch. Fire-rated wired-glass viewing windows afford easy viewing of pass-through chamber contents. Adjustable spring hinges provide self-closure of both doors. These modules bear a UL- listed "10B" label for 1.5 hours in walls (maximum temperature rise to 450°F (232°C) in 30 minutes).



## Testing Standards:

- WH horizontal only
- ASTM-E152
- NFPA 252
- UBC 43-7
- UL vertical UL 10B, horizontal UL 26



# RUGGEDIZED PASS-THROUGH CHAMBERS

- The ideal chamber for heavy use (and abuse!) applications—a nearly indestructible pass-through!
- Prevents damage when operators apply excessive force to an interlocked door
- All-stainless steel construction with double-wall doors and heavy-duty hardware prevents flexing and misalignment
- Spring-action, self-closing doors simplify operation, minimize contamination

Terra's Ruggedized Pass-Throughs stand up to high-use environments where other pass-through chambers fail. Their reinforced, heavy-duty design minimizes maintenance and prevents failure that often leads to costly cleanroom shutdowns.

The double-wall, 2.5" thick doors and all-stainless steel construction prevent door flex or latch misalignment. The chamber retains shape and alignment even when force exceeding 50 pounds is applied to the recessed pull latch.

Dual-side, 0.25"-thick wired safety glass viewing windows are UL fire-rated and provide clear visibility of chamber contents and the opposing door. The 304 stainless steel self-closing spring hinges ensure reliable, hands-free door closure.



Ordering Information*: Ruggedized and Fire-Rated Pass-Throughs				Ruggedized Pass-Throughs		Fire-Rated Pass-Throughs	
For electropolished models, add "-2" to the part number and 20% to the price				304 Stainless Steel**		Electropolished 304 Stainless Steel**	
Nominal Dimensions W" x D" x H"	Outside Dimensions incl. hardware W" x D" x H"	Inside Clearance Dimensions W" x D" x H"	Viewing Window W" x D"	Cat. #	\$/Each	Cat. #	\$/Each
12 x 12 x 12	12.75 x 19 x 12.13	9.38 x 11.88 x 9.5	4.66 x 8	2640-65	3,930.00	—	—
18 x 18 x 24	18.75 x 25 x 24.13	15.38 x 17.88 x 21.5	7 x 16	2640-66	6,594.00	—	—
24 x 24 x 24	24.75 x 31 x 24.13	21.38 x 23.88 x 21.5	7 x 16	2640-67	9,164.00	2641-12	11,576.00
24 x 24 x 48	24.75 x 31 x 48.13	21.38 x 23.88 x 45.5	14 x 28	2640-68	11,345.00	2641-13	14,297.00
36 x 36 x 36	36.75 x 43 x 36.13	33.38 x 35.88 x 33.5	14 x 28	2640-69	13,468.00	2641-14	16,989.00
36 x 36 x 48	36.75 x 43 x 48.13	33.38 x 35.88 x 45.5	14 x 28	2640-70	14,450.00	2641-15	18,215.00

\* Add 0.5" (13 mm) to the outside hardware W x H dimensions for installation cut-out.  
\*\* 316 Stainless Steel also available

# AIR SHOWERS and TUNNELS

- Completely self-contained, pre-wired, fully equipped Air Shower/Tunnel systems help solve decontamination problems
- Modular design lets you order a system to suit your cleanroom
- HEPA filter/blower modules (rated 99.99% efficient @ 0.3 micron particles) wash personnel with ISO 5 air to dislodge and remove particles
- Solid-state microprocessor panel provides programmable control over access door operation
- Interlocking doors minimize contamination, release automatically in the event of power failure
- LED lighting is housed in the ceiling for minimal turbulence
- Available in white powder-coat CR and stainless steel to meet cleanroom requirements
- Variety of sizes and door configurations
- Economical to operate, easy to maintain

These Air Showers and Tunnels offer an effective way to remove surface-deposited particles from personnel—before they get to the cleanroom.

### Enter the Cleanroom — and Leave Your Particles Behind!

Each unit is a fully equipped, protected passageway that allows large numbers of personnel to pass into controlled areas without sacrificing convenience or cleanliness.

Air Showers and Tunnels supply concentrated ISO 5, clean air flows to lift off contamination while an individual stands in, or walks through, a specially constructed air chamber. Whenever an automatic floor switch inside the unit is activated, pressurized air streams from adjustable nozzles at a velocity between 6000 and 8000 feet per minute (30 m/s and 41 m/s), a force that ensures efficient scrubbing action necessary to remove particulate matter. (Air showers in units without floors are activated by motion sensors.)



## Air Showers

Dimensions inches							Blower/Filter Type*	No. of Filters/Blowers	No. of Nozzles	Shipping Weight lbs	Stainless Steel		Powder-Coated CR Steel	
A	B	C	D	E	F	G					Cat. #	S/Each	Cat. #	S/Each
90	52	44	30	32	35.5	35	1	1	20	1600	6010-00A	20,195.00	6010-14A	13,233.00
90	52	56	30	32	35.5	47	1	1	20	1800	6010-01A	21,565.00	6010-15A	16,450.00
90	52	60	30	32	35.5	51	2	1	32	1900	6010-02A	24,018.00	6010-16A	18,362.00
90	52	72	30	32	35.5	63	2	1	36	2100	6010-03A	25,015.00	6010-17A	19,118.00
90	52	84	30	32	35.5	75	2	1	40	3500	6010-04A	26,619.00	6010-18A	20,339.00
90	58	44	26	36	41.5	35	1	1	20	2200	6010-05A	21,565.00	6010-19A	16,449.00
90	58	56	30	36	41.5	47	2	1	32	1800	6010-06A	22,502.00	6010-20A	17,206.00
90	58	60	30	36	41.5	51	2	1	32	2000	6010-07A	25,015.00	6010-21A	19,118.00
90	58	72	30	36	41.5	63	2	1	36	2200	6010-08A	25,768.00	6010-22A	19,692.00
90	58	84	30	36	39.5	75	2	1	40	3300	6010-09A	27,266.00	6010-23A	20,829.00
90	64	60	30	42	47.5	51	2	1	32	2000	6010-10A	25,762.00	6010-24A	19,685.00
90	64	72	30	42	47.5	63	2	1	36	2200	6010-11A	27,298.00	6010-25A	20,853.00
90	70	72	30	48	53.5	63	2	1	40	2400	6010-12A	29,533.00	6010-26A	22,554.00
90	90	96	30	72	75.5	87	2	2	44	5100	6010-13A**	53,208.00	6010-27A**	41,079.00

\* See specifications above for complete information.

\*\* This extra-wide unit features double doors, 3'0" x 6'8" each (914 mm x 2032 mm) at each end. It is ideal for passing large equipment into the cleanroom (features no floor so that carts can roll smoothly).

Nozzles are arranged on walls and ceilings in a uniform pattern to ensure effective distribution of filtered air; the lowest nozzle is positioned 19" (483 mm) off the floor. The closed-loop circulation design directs contaminated air downward through grills and hollow walls of the Air Shower or Tunnel and back to the filter, which removes 99.99% of all particles as small as 0.3 microns.

Interlocking doors prevent unnecessary contamination inflow and thereby prevent cross-contamination of the cleanroom and the Air Shower or Tunnel. They automatically release in the event of a power failure to ensure operator safety. LED lighting, built into the ceiling to allow unimpeded air circulation, ensures full visibility no matter what size or configuration you select. In addition, an emergency stop button on each Air Shower/Tunnel sounds an alarm and releases the door lock for exiting.

### Control Panel Enhances Convenience and Security

Each unit includes a solid-state microprocessor panel (located at the front entrance) that provides complete control over access to the Air Shower/Tunnel (and hence to the cleanroom itself).

It includes a light switch, and audible alarm and alarm reset, and a 4-line, 64-character alpha-numeric LCD display that monitors system function during normal operation and displays menu functions for service and system changes. A 16-key membrane keypad allows a user to turn the system on and off (with a 4-digit code), to get into systems set-up mode (with a 4-digit code), and to program such information as a system clock, cycle time, access door delay, time lock feature, and single-direction access code. These capabilities let you program as much security into your system as you require!

This system also includes full microprocessor diagnostic capabilities, covering operation of the blower, door switch, door lock, and presence sensor/mat switch.

### Clean, Durable Construction

Select models in any of three materials to suit your cleanroom requirements: powder-coated 16-gauge cold rolled steel, 304 stainless steel, or particle board with a plastic laminate that seals all exposed edges. All models feature anodized aluminum access doors with transparent acrylic windows.

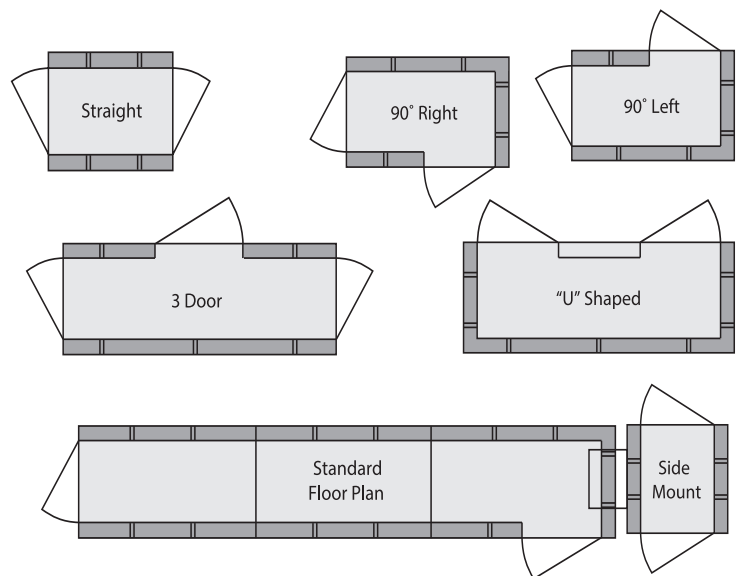
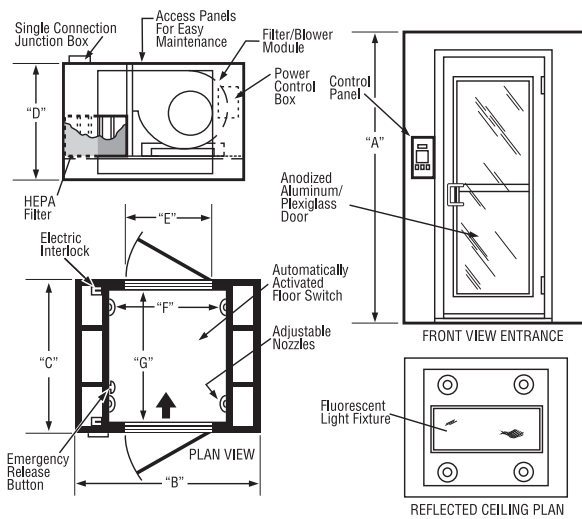

**Knock-Down and Low-Profile models available!**

Air Tunnels							Blower/Fil-ter Type*	No. of Filters/Blow-ers	No. of Nozzles	Shipping Weight lbs	Stainless Steel		Powder-Coated CR Steel	
A	B	C	D	E	F	G					Cat. #	S/Each	Cat. #	S/Each
90	52	96	26	32	35.5	87	1	2	40	4000	6010-42A	36,994.00	6010-52A	28,126.00
90	52	120	26	32	35.5	111	1	2	64	4600	6010-43A	44,244.00	6010-53A	33,641.00
90	52	144	30	32	35.5	135	1	3	60	5200	6010-44A	46,241.00	6010-54A	35,160.00
90	52	180	30	32	35.5	171	2	3	96	5700	6010-45A	62,503.00	6010-55A	47,520.00
90	52	240	30	32	35.5	231	2	4	128	8000	6010-46A	81,144.00	6010-56A	61,698.00
90	58	96	30	36	39.5	87	2	2	64	4400	6010-47A	39,978.00	6010-57A	30,395.00
90	58	120	30	36	39.5	111	2	2	64	4700	6010-48A	46,241.00	6010-58A	35,160.00
90	58	144	30	36	39.5	135	2	2	64	5200	6010-49A	47,766.00	6010-59A	36,320.00
90	58	180	30	36	39.5	171	2	3	108	7200	6010-50A	65,753.00	6010-60A	49,992.00
90	58	240	30	36	39.5	231	2	4	144	8400	6010-51A	84,996.00	6010-61A	64,625.00

\* See specifications above for complete information.



### Thousands of Items in Stock

Popular models of both Terra-built and distributed products are inventoried for quick shipment – look for blue prices at TerraUniversal.com



### Order and Quote Carts

Items priced in blue usually ship in 1-3 days.

**Online ordering requests** for hundreds of stocked items ready for immediate shipping

**Online quote requests** for made-to-order and custom products,



### Low-Cost Domestic and International Shipping

Competitive quotes include customs brokerage and duties for door-to-door delivery



### Hassle-Free Pricing

Web prices honored worldwide



### Comprehensive Product Lines



Terra provides single-source convenience at remarkable savings. Complete lines of laboratory products at Laboratory-Equipment.com



### Global Network of Sales Representatives

Complete listing at TerraUniversal.com