

CRITICAL ENVIRONMENT SOLUTIONS

Designing and Manufacturing
Turnkey Systems Since 1976

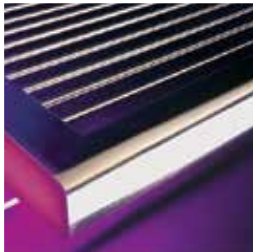

Temperature
Control
—
Biohazard
Containment
—
Sterilization



Particle Filtration
—
Laminar Flow
Control
—
Ultra-Clean
Materials



STATIC CONTROL
—
CHEMICAL VAPOR
REMOVAL
—
ANTI-MICROBIAL
TREATMENTS



Humidification/
Dehumidification
—
Vacuum Control
—
Exhaust Fume
Ventilation



Low-Cost Solutions for High-Technology

Hardwall Designs

- Acrylic, polycarbonate, or static-dissipative PVC rigid panels for full visibility
- Steel support frame spans up to 20 feet without internal pillars or external supports
- Mirror-finished exterior stainless steel trim
- A/C and humidity controls
- Available raised floors optimize laminar airflow





Convert any space into a controlled environment — at a fraction of the cost, in a fraction of the time!

Whatever your application, Terra will deliver a pre-tested, turnkey system to your schedule.

QuickQuote Planner

quickly configures a system to your specifications: www.TerraUniversal.com

Shown: Terra Hardwall Modular Cleanroom with acrylic panels and furnishings:

- Rod-top electropolished SS Table with "C" base (No. 9604-01)
- Gowning Bench with Bootie Rack (No. 1530-25-2/1560-30-2)
- Wall-mount Stainless Steel Glove Dispenser (No. 4951-33-2)
- Acrylic Pass-Through Chamber (No. 6704-93B)
- Cleanroom Storage Cabinet (No. 4101-13B)
- Vertical Laminar Flow Workstation (No. 2001-82A)
- Stainless Steel Waste Receptacle (No. 1456-01)
- Class 100 Cleanroom Chair (No. 2802-62)

SOFTWALL CLEANROOMS

- Portable, expandable, easy to assemble & disassemble
- Solid panels and parting strip shields, in dissipative and nondissipative clean materials
- Rigid steel support frame requires no ceiling supports



Standard Softwall Design



Valuline™ Softwall Cleanroom:

- 12 standard sizes
- ISO 5—ISO 8
- All models ship within a week!

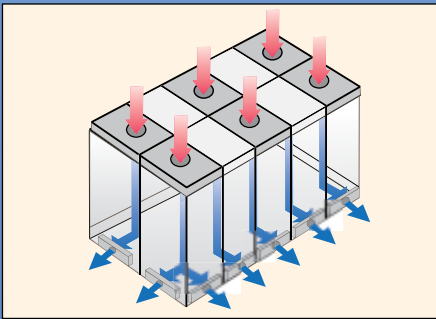

A. Single-Wall Laminar Flow Cleanroom

Internally mounted plastic panels create smooth, easy-clean surfaces and allow full visibility. Exit filters available to capture powders and other sub-micron particulates or chemical vapors.

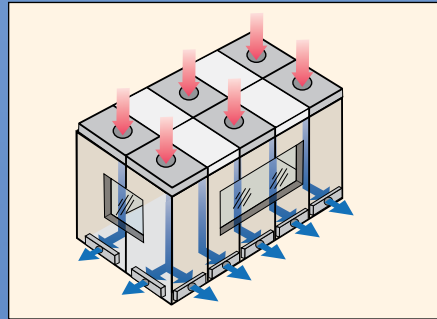

B. Double-Wall Steel Laminar Flow Cleanroom

Stainless or powder-coat steel structure features rounded corners for easy cleaning. Double-wall construction is ideal for high/low temperature applications. Available with anti-microbial coatings and raised floor.

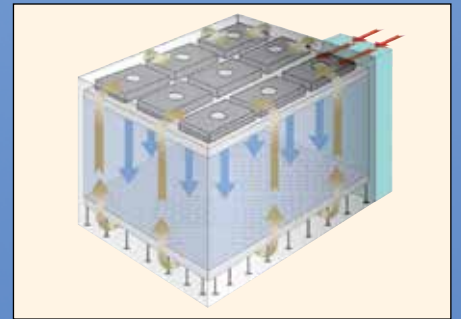

C. Double-Wall Plastic Laminar Flow Cleanroom

Ideal for applications that require full visibility and raised flooring for true laminar flow. Double-wall structure allows air to circulate through the inter-wall plenum, increasing filtration and A/C efficiency.

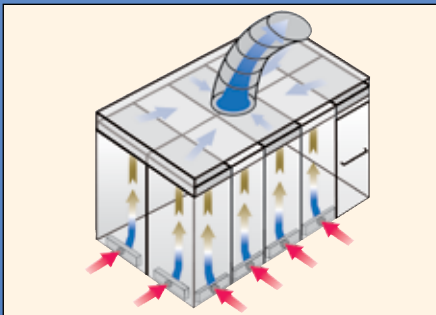

D. Ventilation Room

Adjustable ceiling ventilator draws air upward through HEPA filters and/or exhaust duct work. Ideal for safe removal of fine powders or chemical vapors. Select among several transparent plastic and steel panel designs.

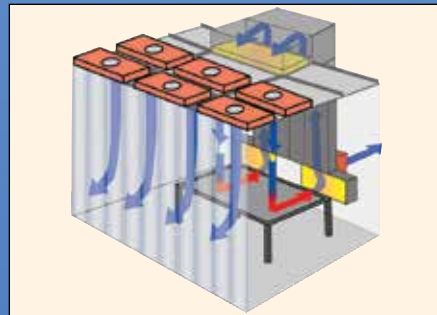

E. Powder-Containment Room

Air recirculation zone draws powders away from personnel into a dual HEPA filtration system to protect both product and personnel. Adjustable air handler creates overall negative pressure to protect the external environment.

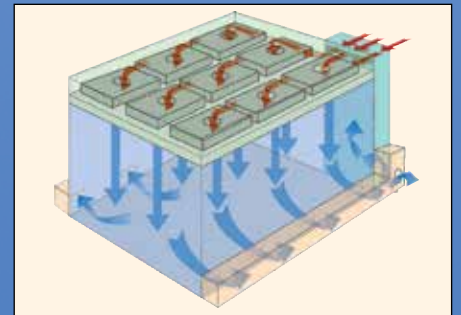

F. Negative-Pressure Cleanroom

Ceiling filter/fan units create laminar flow of particle-free air. Exhaust ductwork and adjustable air handlers create overall negative pressure to protect external environment from pharmaceutical powders and biohazards.



Class A Fiberglass-Reinforced Plastic (FRP) and C-PVC panels are Factory Mutual approved and ISO 5 certified (shown with automatic doors)



BIOSAFE® FRP, C-PVC AND ALL-STEEL CLEANROOMS

- Smooth interior walls—easy to wash down, sterilize
- Sealed panels with radius corners eliminate cracks and crevices
- Positive-pressure and negative-pressure models for laminar flow or exhaust ventilation
- Steel ceiling grid requires no external bracing, accepts standard filters and lighting modules
- 304/316 stainless steel or powder-coat steel
- Anti-microbial panel coatings available
- Air recirculation system boosts A/C and filtration efficiency



Powder-Coated Steel BioSafe® Cleanroom

PASS-THROUGH CHAMBERS; dozens of standard sizes



All models below



Acrylic chamber for Terra Hardwall Cleanroom, No. 6704-90B



Acrylic chamber, No. 6704-90B



Stainless steel chamber, No. 6705-26C



CleanSeam+™ stainless steel designs with seamless interior corners



Fire-Rated Pass-Through, No. 2641-02



Stainless steel ventilation module, No. 6705-23



Ruggedized Pass-Through, No. 2640-66

BIOSAFE® + PASS-THROUGH CHAMBERS

Now with all-304/316 stainless steel latches to eliminate scratching, corrosion and contamination common with plated hardware.



- **Flush-Mount Design** — one-piece integral bracket eliminates hardware and cracks that harbor germs
- **Seamless** — Unique design eliminates cracks, corners and other contaminant traps!
- **Lipless** — Easy material transfer with no clearance obstruction
- **Easy to Clean** — Ultra-smooth internal surfaces
- **Easy to Sterilize** — 304/316 SS; removable doors can be autoclaved
- **Double-Wall, Sealed Construction** — adds rigidity and houses interlock and standard or custom utilities without compromising the ultra-clean design
- **Two Minutes to Install!** — View the video at TerraUniversal.com



No. 6705-10B



No. 6705-12B



No. 6705-13A

Roll-Up Door Models

- Push-button operation
- Electronic interlocks
- HEPA air showers



Pass-Through Air Shower No. 6705-70



Polypropylene Modular Cleanroom with Fast-Action Roll-Up Door No. 6710-53



- Completely self-contained, pre-wired, fully equipped Air Shower/Tunnel systems help solve decontamination problems
- Modular design lets you order a system to suit your cleanroom
- HEPA filter/blower modules (rated 99.99% efficient @ 0.3 micron particles) wash personnel with ISO 5 air to dislodge and remove particles
- Solid-state microprocessor panel provides programmable control over access door operation
- Interlocking doors minimize contamination, release automatically in the event of power failure
- LED lighting is housed in the ceiling for minimal turbulence
- Available in white powder-coat CR and stainless steel to meet cleanroom requirements
- Variety of sizes and door configurations
- Economical to operate, easy to maintain

These Air Showers and Tunnels offer an effective way to remove surface-deposited particles from personnel—before they get to the cleanroom.

Enter the Cleanroom — and Leave Your Particles Behind!

Each unit is a fully equipped, protected passageway that allows large numbers of personnel to pass into controlled areas without sacrificing convenience or cleanliness.

Air Showers and Tunnels supply concentrated ISO 5, clean air flows to lift off contamination while an individual stands in, or walks through, a specially constructed air chamber. Whenever an automatic floor switch inside the unit is activated, pressurized air streams from adjustable nozzles at a velocity between 6000 and 8000 feet per minute (30 m/s and 41 m/s), a force that ensures efficient scrubbing action necessary to remove particulate matter. (Air showers in units without floors are activated by motion sensors.)

Air Showers

Dimensions inches							Blower/Filter	No. of Filters/Blowers	No. of Nozzles	Shipping Weight lbs	Stainless Steel		Powder-Coated CR Steel	
A	B	C	D	E	F	G					Cat. #	S/Each	Cat. #	S/Each
90	52	44	26	32	35.5	35	1	1	20	1600	6010-00A	20,195.00	6010-14A	13,233.00
90	52	56	26	32	35.5	47	1	1	20	1800	6010-01A	21,565.00	6010-15A	16,450.00
90	52	60	30	32	35.5	51	2	1	32	1900	6010-02A	24,018.00	6010-16A	18,362.00
90	52	72	30	32	35.5	63	2	1	36	2100	6010-03A	25,015.00	6010-17A	19,118.00
90	52	84	30	32	35.5	75	2	1	40	3500	6010-04A	26,619.00	6010-18A	20,339.00
90	58	44	26	36	69.5	35	1	1	20	2200	6010-05A	21,565.00	6010-19A	16,449.00
90	58	56	30	36	41.5	47	2	1	32	1800	6010-06A	22,502.00	6010-20A	17,206.00
90	58	60	30	36	41.5	51	2	1	32	2000	6010-07A	25,015.00	6010-21A	19,118.00
90	58	72	30	36	41.5	63	2	1	36	2200	6010-08A	25,768.00	6010-22A	19,692.00
90	58	84	30	36	39.5	75	2	1	40	3300	6010-09A	27,266.00	6010-23A	20,829.00
90	64	60	30	42	47.5	51	2	1	32	2000	6010-10A	25,762.00	6010-24A	19,685.00
90	64	72	30	42	47.5	63	2	1	36	2200	6010-11A	27,298.00	6010-25A	20,853.00
90	70	72	30	48	53.5	63	2	1	40	2400	6010-12A	29,533.00	6010-26A	22,554.00
90	90	96	30	72	75.5	87	2	2	44	5100	6010-13A**	53,208.00	6010-27A*	41,079.00

* This extra-wide unit features double doors, 3'0" x 6'8" each (914 mm x 2032 mm) at each end. It is ideal for passing large equipment into the cleanroom (features no floor so that carts can roll smoothly).

GOWNING ROOM PRODUCTS

*Optimize space and cleanliness
in your cleanroom changing area*

Terra's comprehensive product line offers
economical, effective solutions at every
step of the gowning process.



A



Most items
shown here



Frameless
Wall-Mount
Mirror,
No. 5252-60A



B

No. 5252-65A



C



D

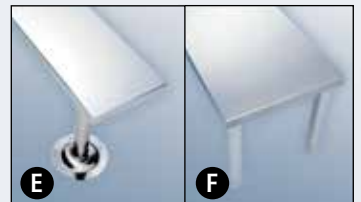

E

F

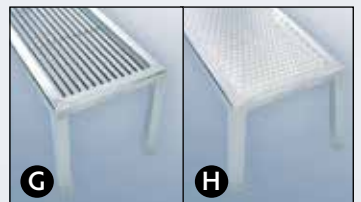

G

H

A. Garment and Supplies Cabinet

With Internal HEPA Filtration. No. 4101-04B

B. Cleanroom Mirror –

Visual self-check ensures proper gowning. Free-standing No. 5252-65A shown; wall-mount models available.

C – H. Electropolished Gowning Benches

C. Cylinder Tube Bench

No. 9602-97 (4' long)

D. Perf.-Top Bench with Rack

No. 1540-10-2 bench with
No. 1560-30-2 rack (3' long)

E. Floor-Mount Solid-Top Bench

No. 1530-16-2 (4' long)

F. Solid-Top Bench

No. 1530-26-2 (4' long)

G. Rod-Top Bench

No. 1530-11-2 (4' long)

H. Perf.-Top Bench

No. 1540-11-2 (4' long)

I. PureDry™ Hand/Glove Dryer

Germ-Free Model, No. 3333-33
Single-Pass Model, No. 3333-00

J. Washing/Drying Station

No. 9600-63

K. Garment Rack –

Cylinder Tubes, No. 9602-76

L. Garment Rack –

Collapsible Frame, No. 9230-01-2

ULPA filtration stops bacterial spread!



I Single-Pass Model



I Germ-Free Recirculation Model



Standard sizes with one to six stations

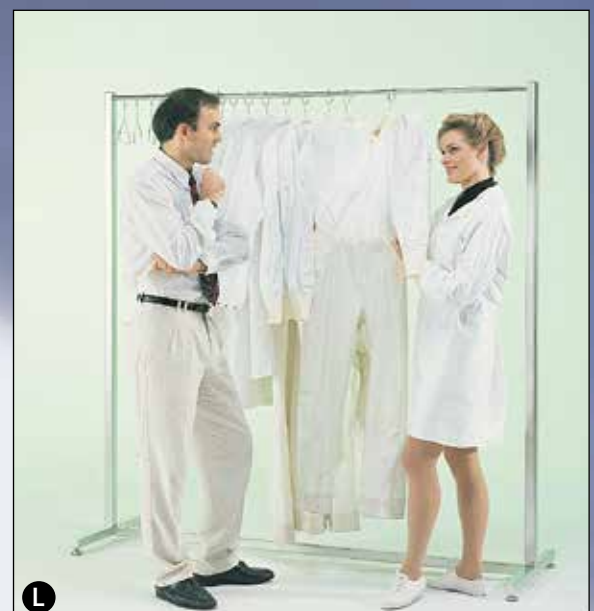

CLEANROOM WORK STATIONS

Over 200 standard sizes and frame configurations —
Get complete specs and pricing at www.TerraUniversal.com



*OpenTop™ Perf-Top Bench
with Recessed "C"-Base
(No. 9601-62)*

*Hidden reinforcements add
strength and create superior
laminar flow-through*

Dozens of models to meet all cleanliness requirements (to class 10/ISO 4), in stainless steel, cleanroom and dissipative laminates, and chemical resistant polypropylene.



*Stainless steel solid top
(No. 1521-55, shown with optional drawers)*



Electropolished stainless steel Rod Top (No. 9601-20)



*Static-dissipative laminate top
(No. 1521-32, shown with optional drawers, shelf and light)*



*Polypropylene top and adjustable telescoping legs
(No. 1522-01, shown with optional drawers)*

CLEANROOM CHAIRS

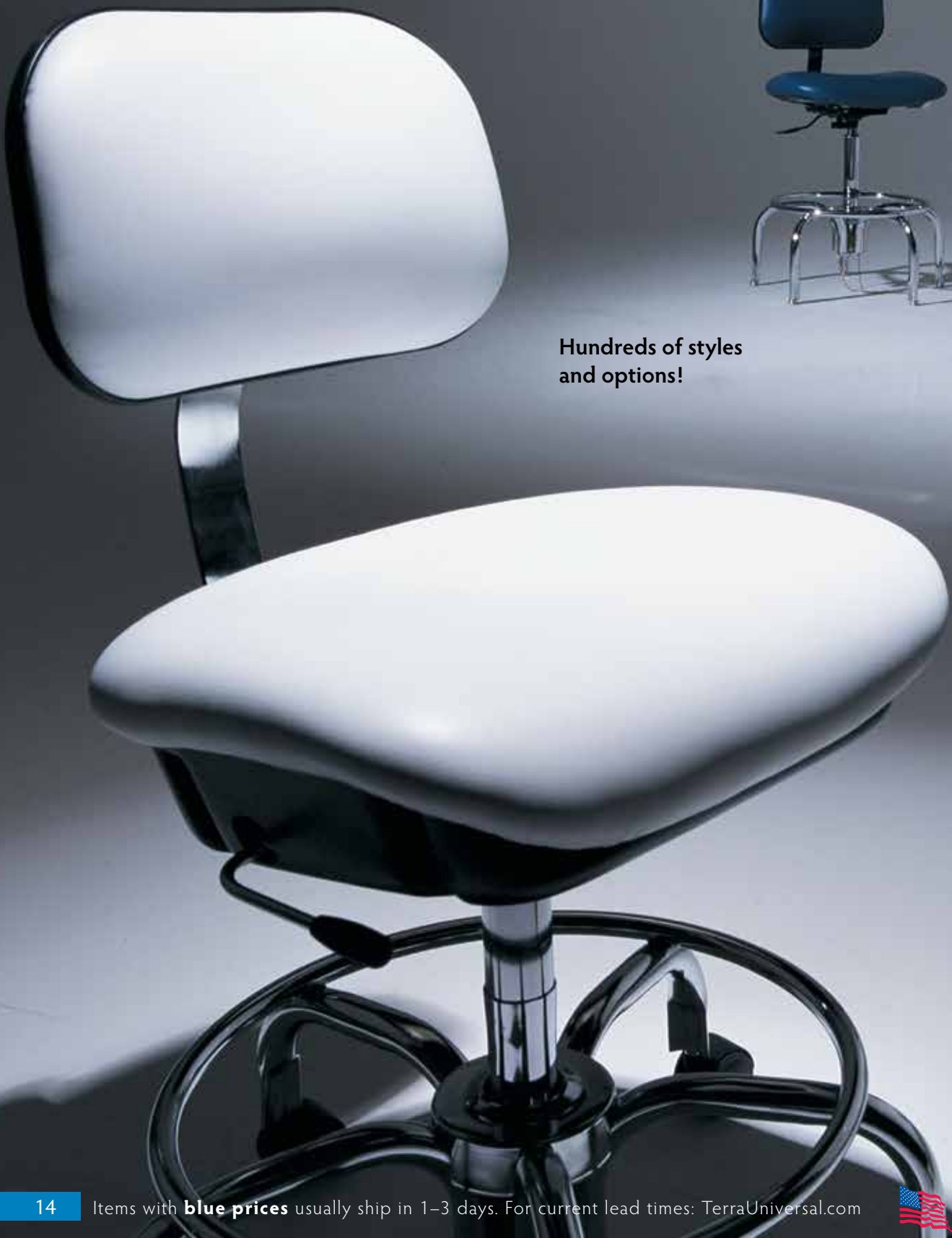

Hundreds of styles
and options!

Vibration Isolation Tables and Platforms

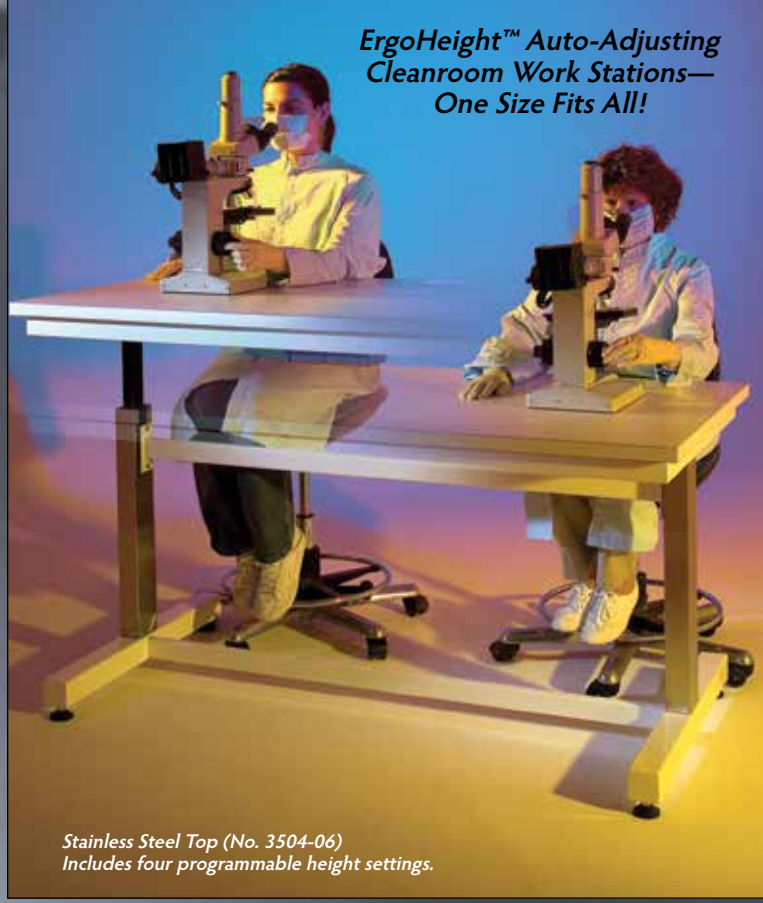
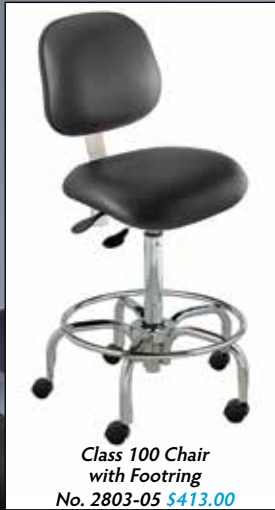

STAINLESS STEEL GLOVE BOXES

- Modular designs let you configure a chamber to your exact process specifications—using standard control modules and standard pricing!
- Pass-through air locks, vacuum chambers and ovens accommodate applications in many industries

- Radius corners available for easy wipe-down or sterilization in applications with hazardous materials or biological samples
- Double-wall, insulated models available for low/high-temperature processing



Double-wall Refrigerated Chamber No. 1695-03



Pharmaceutical Compounding Isolation Chamber No. 2900-46C



Drying/Degassing Chamber No. 1694-13B with Air Lock No. 1698-01C



HEPA-Filtered Low-Humidity Chamber Includes High-Volume Gas Mixer, No. 1695-01

Select the Environmental Controls For Your Requirements



Humidity Control

Maintain the humidity level you specify.



Process Gas Generation & Analysis

Gas generators, mixers, and monitors.



Temperature Control

A wide range of process temperature solutions, from -40° to +300°C.



Vacuum Control

A wide range of process pressures, from 5" W/G to one atmosphere.



Static Control

Ionizers and dissipative materials to protect sensitive parts against ESD.



Particle and Germ Control

Helps you meet FDA and cleanliness requirements as low as ISO 4.



Anaerobic Test Chamber

Designed for drug efficacy and dosing studies with anaerobic microbes. Touchscreen control activates nitrogen purge to achieve low oxygen level (to 0.1%), as well as UV sterilization and ventilation cycles for all chambers. Antechambers feature pneumatic doors with electronic interlocks to prevent environmental exposure.



PLASTIC GLOVE BOXES

- Select among dozens of standard sizes, in several materials —
 - Static-Dissipative PVC controls static charges and the particles they attract
 - Polypropylene resists acids and corrosives
 - Polycarbonate resists chemicals and thermal stress
 - Acrylic is strong, affords full visibility of work in process
- Mix and match environmental controls to create the processing environment you require
- Pass-through air locks and vacuum chambers accommodate applications in many industries
- Standard models from 35" to 71" wide, with modifications to meet your specs
- Whatever your requirements, Terra delivers a tested turnkey system, ready for operation!

No. 1681-32F with optional air lock and gas controls





A



B



C



D



Models shown

- A. Smart Glovebox No. 3305-30A with Hypalon Gloves
- B. Life Science Glove Box with inlet/outlet ULPA filtration
- C. Compounding Aseptic Isolator Terra's ValuLine™ Isolator is rigid polypropylene. Meets USP-797 compounding requirements. Stainless steel model also available. Shown: No. 2900-62
- D. Polypropylene Glove Box No. 1681-29F, shown with optional air lock and nitrogen purge controls
- E. VersaFlow Laminar Flow Compounding Aseptic Isolator from GermFree
- F. Pass-Through Ovens
- G. Nitrogen and Dry Gas Generators. See page 27



E

Dry Air and Nitrogen Generator—see page 37



F



G



- HEPA/ULPA-filtered enclosure provides a clean, static-safe work environment
- Vertical and horizontal flow stations available with powder-coated or easy-clean stainless steel finish
- Hundreds of standard sizes and configurations, with modifications to handle any application!

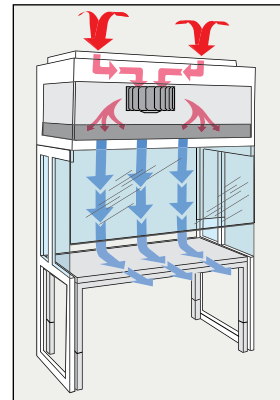

Vertical Laminar Flow Station, No. 2001-83A, shown with optional cleanroom bench No. 2402-00



Status Indicator—shows HEPA fan is operational

Return air ducts minimize turbulence and backwash

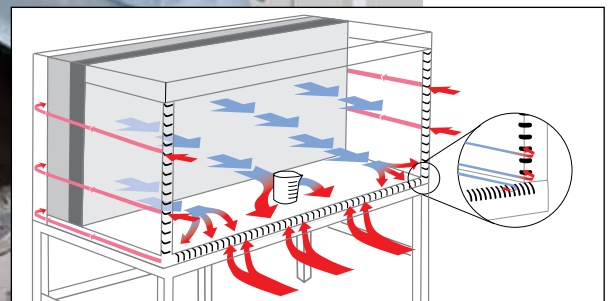

Model shown: No. 9620-64
For complete specifications:
TerraUniversal.com



ValuLine™ Workstation No. 2001-68/\$4,948.00
Complete system includes frame, workstation and hood



ValuLine™ WhisperFlow™ Hood No. 1688-40/\$1,618.00
Economical polypropylene dust-free enclosure

A. ValuLine™ Laminar Flow Workstations

This low-cost, completely integrated workstation includes a powder-coated or stainless steel frame, stainless steel work surface, and laminar flow HEPA filtration module with tilting sash, fluorescent light, and backpressure gauge. Several sizes available.

B. ValuLine™ WhisperFlow™ Benchtop Laminar Flow Hood

This all-polypropylene laminar flow hood provides a vertical flow of HEPA-filtered air to the work bench. Order desired work surface separately. Integrated polypropylene bottom include raised lip to capture chemical spills. Many sizes available.

C. CleanBooth™ Laminar Flow Station

This modular system includes a stand that support HEPA filtration modules. Select vinyl side panels, casters, and desired work surface separately.



CleanBooth™ Laminar Flow Hood No. 1870-02,
with side curtains and FFUs

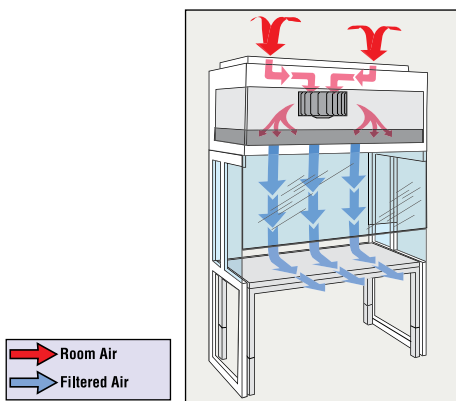



All available with activated charcoal filtration for safe indoor fume release.

A. Benchtop Ductless Exhaust Fume Hood

High-capacity hood features dual blowers with carbon filtration in a chemical-resistant polypropylene housing. Model shown: 2900-20.

B. DownDraft Workstation

Ideal for soldering or chemical processing that requires exhaust removal. Fumes are drawn downward, through carbon filters. Model shown: No. 1728-01.

C. HEPA-Filtered Ventilation Hood

Perfect for containing particles during benchtop process such as milling, powder analysis and packaging. Reverse-flow HEPA filtration system captures micro-contaminants.

D. High-Clearance Chemical Fume Hood

Activated carbon and final HEPA filters remove contaminants. Maintains >100 ft/min. air speed with 15" of working clearance.

E. Exhaust Fume Station

Available in four widths, either stainless steel or powder-coated steel. Model shown: 2400-14, with optional work bench No. 2402-00.



E Shown with optional Cleanroom Bench.

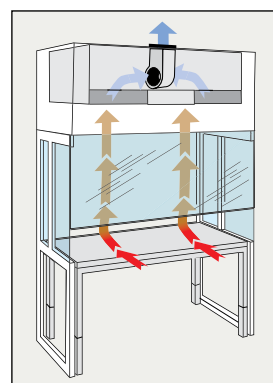

Ductless models include chemical vapor filters

BENCHTOP LAMINAR FLOW HOODS

A. WhisperFlow™ Laminar Flow Hood

Horizontal configuration. Available in five materials, three standard sizes. Model shown: 1686-50B.



B. WhisperFlow™ Laminar Flow Hood

Vertical configuration. Available in five materials, three standard sizes. Model shown: 1686-55B.

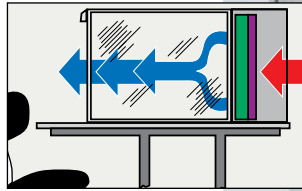

C. ValuLine™ Dust-Free Hoods

Economical enclosures provide a vertical flow of HEPA-filtered air to protect contamination-sensitive processes. Model shown: No. 1715-09B acrylic hood, also available in four other application-specific materials.



A No. 1686-55C-55



B No. 1686-60C

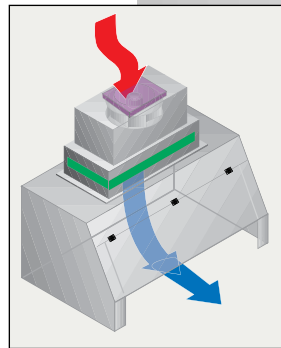

C

EQUIPMENT ENCLOSURES

• Interchangeable Access Panels:

- Solid Panels
- Iris Ports
- Glove Ports
- Access doors
- Microscope bellows
- Custom interface modules

• Many Panel Materials:

- 304/316 Stainless Steel
- Dissipative PVC
- Polycarbonate
- Acrylic
- Polypropylene
- Tempered Glass

• HEPA/ULPA filter/blower – laminar flow or recirculating

• Low/high temperature and humidity monitor/control modules

• Vibration-isolated work surfaces

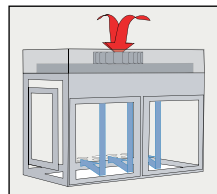



A. Protector Premier® Laboratory Hoods

The only high-performance hoods available with built-in blowers, these benchtop units provide excellent containment of chemical fumes and meet SEFA-1 regulations at a face velocity as low as 60 fpm. Bypass units available. Model shown: 3649-00.

B. Basic Laboratory Hoods

By-pass design maintains stable face velocity, and vapor-proof or explosion-proof blower provides safe ventilation. Available in 47" and 70" widths, with a complete range of system options. Model shown: 3646-05.

C. Paramount Ductless Enclosures

These self-contained workstations require no ducting to the outside, making them ideal for applications that require portability or flexible installation. An air foil enhances fume containment. Many sizes and accessories, including filters, at TerraUniversal.com

D. Protector XVS™ Ventilation Stations

This low-profile, large-capacity enclosure provides the perfect fume hood for analytical work, solvent cleaning, pathology and cytology studies. By-pass design maintains stable air velocity, and Clean-Sweep™ air foil minimizes "dead air" zones to maximize containment. Model shown: No. 3646-19. Select FilterMate below for ventilation.

E. Purifier® Logic® Series Biological Safety Cabinets

Meets NSF designation for Class II, Type A2 biological safety cabinets. The Purifier® also offers the largest working area of any cabinet in its class and includes a fully closing, counterbalanced tempered glass sash with alarm indicator. Model shown: 3645-45.

F. Protector® XStream® Laboratory Hoods

These high-performance, low-volume benchtop bypass models provide maximum containing and energy savings—meets SEFA-1 standards when subjected to ASHRAE 110 text protocol. Bypass units available in widths of 4, 5, 6 and 8 feet. Model shown: 1538-34.



BIOSAFE® CLEANROOM CONVERSION SYSTEM

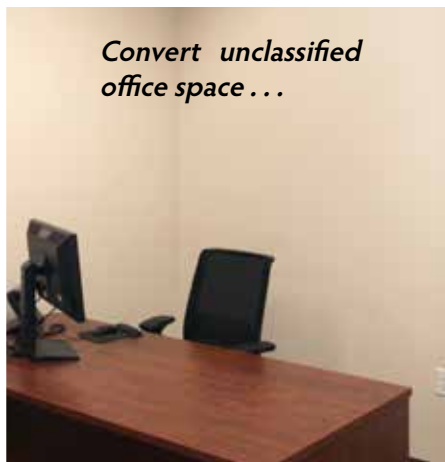

Convert unclassified office space . . .



. . . into an ISO 5 – 8 cleanroom!

The Biosafe Cleanroom Conversion System is an ideal solution for universities, government laboratories and other facilities looking to convert a standard office or other unclassified space into an ISO 5 – 8 cleanroom. Models are custom quoted according to your specification.

Unique Three-Part System Includes:

- Modular ceiling grid
- BioSafe Cleanroom Wall System (FRP or C-PVC panels)
- Various flooring and other options to meet your cleanliness requirements

Ceiling Grids: Rigid, all-steel interlocking and self-supporting meets ISO 5 – 8 requirements. Mounts directly to existing wall or rest on top of walls with no ceiling. Extends up to 20 feet without the need for internal support columns or ceiling suspension wires.

Cleanroom Wall System: Made of FRP or C-PVC. Mounts to any wall type (also accommodates USP-797 Compounding Cleanrooms).

Room-Side Replaceable Fan/Filter Unit: Available with HEPA and ULPA filters.

Cleanroom Lighting: Available in LED strips or fluorescent ceiling modules.

Pass-Throughs and Air Showers: Reduces cross contamination.

Cleanroom Doors: Available in Aluminum Frame Swing Door, Aluminum Frame Sliding Door and Stainless Steel Swing Doors.

Service Outlets: For installation of electrical and vacuum/gas utility outlets.

Terra provides complete pre-sale and after-sale support. Call Terra for complete quotations including drawings (if applicable) and manufacturing time.

Installation:

Terra can also install your BioSafe Cleanroom Conversion System and perform a seismic analysis, or provide installation support for local contractors.



Easy to clean and sterilize contamination-free processing environment for bio-pharmaceutical and other operations.



Economical design maintains ISO 5 – 8 conditions.

BIOSAFE FRP/C-PVC MODULAR CLEANROOMS

Features HEPA or ULPA fan/filter units; status indicator lights, ceiling panels in choice of polypropylene, acrylic or fire-safe steel, fluorescent or LED lights, display panel, choice of swing door or infrared-activated fast-response sliding doors, choice of internal wall panels (FM-approved FRP or C-PVC), all-steel ceiling grid with welded or interlocking BioSafe design. Free-standing structure requires no external bracing or ceiling suspension.

HYBRID CLEANROOM

This cleanroom combines several design features of Terra's other models. Like standard hardwall cleanrooms, it features ceiling HEPA fan/filter units that meet ISO 5-8 cleanliness standards and maintains internal positive pressure that prevent particle influx. Its anti-static vinyl panels form a smooth interior, like those of a BioSafe Cleanroom, that can be wiped clean and sterilized, making it suitable for bio/pharmaceutical applications. And, like Terra's softwall rooms, it provides cleanroom performance at low cost. Call to discuss your application.

DESICCATOR STORAGE AUTOMATED HUMIDITY CONTROL

NitroPlex™ Humidity Control System

Senses and displays %RH in each chamber independently for optimal efficiency

Model shown: No. 3950-36ANP, with control modules, optional SmartPlex™ computer, stainless steel door frames and stand.



EXTEND SHELF LIVES • REDUCE DEFECT RATES • BOOST YIELDS

The Most Advanced Features and Control Systems Available —

- Nitrogen-purge or regenerating desiccant models
- Smart gas controller maintains ultra-low humidity levels, cuts nitrogen expenses
- Stainless steel doors extend cabinet life
- Full plenums for strength and efficiency
- Contamination and static control systems, including dissipative plastics
- Hundreds of standard sizes and configurations



**QUICK
Ship**

No. 1911-02C



Chamber RH
control/display
module

*SmartDesiccator™ Benchtop Desiccator
Integrated N₂ control system reduces nitrogen cost by 78%.
Thirty-second installation!*



*SmartDesiccators also available in acrylic and static-dissipative
PVC designs. Model shown: No. 19111-41*

ACRYLIC and DISSIPATIVE PVC DESICCATORS

Durable low-humidity storage systems retard oxidation and other chemical reactions to protect sensitive materials



Hundreds of Standard Sizes and Configurations . . .

ValuLine™ Desiccators – Value without Compromise!

- Five configurations (1, 2, 3, 4 or 5 chambers) in acrylic or static-dissipative PVC
- Reinforced cabinet design with close-cell door gaskets and compression door latches
- Turnkey systems include bleed valve and flowmeter

Acrylic Models

No. of Chambers	Cat. #	#/Each
1	3949-00A	290.00
2	3949-01A	690.00
3	3949-02A	1,120.00
4	3949-03A	1,192.00
5	3949-04A	1,441.00

Static-Dissipative PVC Models

No. of Chambers	Cat. #	#/Each
1	3949-10A	401.00
2	3949-11A	1,123.00
3	3949-12A	1,587.00
4	3949-13A	2,036.00
5	3949-14A	2,500.00

ValuLine™ Desiccator No. 3949-02, shown with optional stainless steel shelves

WHICH HUMIDITY CONTROL SYSTEM IS BEST?

Terra's nitrogen purge controllers deliver the efficiency and economy your application requires.

Control System	Relative Humidity Set Point Control (to 0% RH)*	Access & RH Datalogging	Multiplexed Monitor/Control (to 0% RH)** for Fast Recovery	Multiple RH Set Points in a Single Cabinet	Use in Large, Multi-Chamber Desiccators	Use in Small Desiccators	Variable N ₂ Purge Compensates for Frequent Access	Requires Automatic RB® Valve(s)***
SmartDesiccator™	•					•	•	•
NitroPlex™ System	•	•	•	•	•		•	Included
Dual Purge™/NitroWatch™ Systems	•				•	•	•	•
Dual Purge™ System					•	•	•	•
Flowmeter						•		•

* RH maintained through nitrogen purge; system includes moisture sensor(s).

** Nitrogen purge delivered only to chamber that exceeds RH set point.

*** One recommended per chamber to ensure rapid contaminant purging and fast humidity recovery.

STAINLESS STEEL DESICCATORS

The ideal storage enclosure for your most moisture-sensitive materials



LiftLatch™ Extends Cabinet Life
Now available in all-stainless steel construction to prevent corrosion

Custom Designs
 To Your Specifications



Whether a size modification or a whole new design, Terra builds to your requirements. Model shown: electropolished stainless steel desiccator with double-side access (ref. no. 108096)



SmartPlex™
 monitor/control
 computer

No. 1609-11ANP pass-through desiccator with optional NitroPlex™ humidity controller, stand and casters



No. 1609-02ANP with optional stand, casters



No. 1610-32A with optional shelf

SPECIALTY APPLICATIONS

Terra's standard systems optimize storage density and access convenience of many parts: tote boxes, kitting trays, IC tubes, carrier reels, and more!



DesiCart™
 No. 4001-91B



Faraccator™ Static-Safe Desiccators



Kitting Tray Desiccator No. 6006-00A



A. – I. Electropolished Step Stools and Ladders
 Include spring-loaded safety casters that retract under load. Perforations limit particle accumulation. Custom sizes and 316 SS available.

304 Stainless Steel Step Stools and Ladders

	Top Platform (W" x D")	Overall Dimensions (W" x D" x H")	No. of Steps	Electropolished 304 Stainless Steel	
				Cat. #	S/Each
A	30 x 14	30 x 20 x 24	2	2805-50A-2	1,891.00
B	30 x 12	30 x 28 x 34	3	2805-51A-2	2,380.00
C	30 x 12	30 x 24 x 60	3*	2805-53A-2	2,761.00
D	30 x 12	30 x 30 x 70	4*	2805-52A-2	4,037.00
E	30 x 16	30 x 40 x 80	5*	2805-54A-2	4,928.00
F	30 x 36	30 x 76 x 86	5*	2805-55A-2	5,152.00
G	15 x 10	18 x 16 x 20	1	2805-80A	946.00
H	15 x 10	18 x 22 x 35	2	2805-81A	1,315.00
I	15 x 10	18 x 25 x 44	3	2805-82A	1,586.00
J	11 x 17	21 x 27 x 48	3	2805-97	2,345.00

* Includes safety handrail. C – E not shown



K. – O. Waste Receptacles

ValuLine™ models, suitable for general use, are stainless steel. BioSafe® models, optimized for the cleanest locations, are either electropolished SS or polypropylene and feature a soft-close feature to eliminate abrupt noises when the lid closes.



- ▲ **BioSafe Models:** eliminate piano-style hinges and other hardware that harbors contaminants; all non-corroding materials (electropolished stainless steel or polypropylene) - perfect for critical environments. SoftClose™ feature lets lid close without a loud crash!
- ▲ **ValuLine Models:** suitable for general laboratory use.

BioSafe Cleanroom Waste Receptacles

Type	Capacity (Gallons)	Dimensions W x D x H (in.)	Ship. Wt. (lbs.)	Electropolished 304 Stainless Steel		Ship. Wt. (lbs.)	Polypropylene		ValuLine Waste Receptacles 304 Stainless Steel	
				Cat. #	S/Each		Cat. #	S/Each	Cat. #	S/Each
K	3.5	11 dia. x 17 H	9	—	—	9	—	—	1456-00	334.00
L	7	12 x 12 x 17	19	1456-16B	782.00	19	1456-25A	629.00	1456-01	518.00
M	12	12 x 12 x 23	24	1456-17B	1,006.00	24	1456-26A	767.00	1456-02	611.00
N	24	15 x 15 x 30	36	1456-18B	1,162.00	36	1456-27A	879.00	1456-03	823.00
O	40	19 x 19 x 30	48	1456-19B	1,623.00	48	1456-28A	1,047.00	1456-04	1,058.00



A. Motorized Shoe Cleaner

Internal vacuum system removes contaminants on shoes. Five internal brushes clean deep into seams, welts.

	Cat. #	S/Each
110VAC, 50/60Hz	1784-14	2,995.00
220VAC, 50Hz	1784-14-220	3,325.00
Exhaust HEPA Filter Kit (includes filter)	1784-13	495.00

B. Bulldog 351 Shoe Brush Machine by Liberty Industries

This sturdy unit quickly and easily brushes away dirt, mud, leaves, slush and sand from footwear. The 16-gauge stainless steel housing and nickel-plated shafts reduce corrosion. Includes non-abrasive rotating heavy-duty nylon brush and 6' power cord for 120V/60Hz operation. Units require a vacuum attachment (order separately below).

	Cat. #	S/Each
Bulldog 351	7575-00	4,284.00
Non-HEPA Wet/Dry Vacuum	7575-01	747.00
HEPA Dry-only Vacuum	7575-02	729.00
Wet/Dry HEPA Vacuum	7575-03	1,387.00

C. Sticky Mats®

Peel-off sheets eliminate the need for messy cleaning and make it easy to maintain a clean surface. All below are medium tack; many other styles available.

Dimen. W" x D"	Blue (full bottom)		Grey (2" bottom)	
	Cat. #	S/Each	Cat. #	S/Each
18 x 36	5601-16	45.00	5602-20	43.00
18 x 45	5601-17	53.00	5602-21	49.00
24 x 36	5601-18	62.00	5602-22	60.00
26 x 45	5601-19	77.00	5602-23	74.00
36 x 36	5601-20	90.00	5602-24	90.00
36 x 45	5601-21	110.00	5602-25	107.00
36 x 60	5601-22	165.00	5602-26	165.00

Dimen. W" x D"	White (2" bottom)		Corresp. Frames	
	Cat. #	S/Each	Cat. #	S/Each
18 x 36	5602-68	43.00	5602-93	116.00
18 x 45	5602-69	49.00	5602-94	130.00
24 x 36	5602-70	60.00	5602-97	143.00
26 x 45	5602-71	74.00	5602-99	153.00
36 x 36	5602-72	90.00	5603-03	176.00
36 x 45	5602-73	107.00	5603-04	194.00
36 x 60	5602-74	165.00	5603-05	222.00



D. Automatic Shoe Cover Dispenser & Remover by Protexer

Once shoes are cleaned, it's time to don shoe covers before entering the gowning room and garbing up. The KineticButler and BootieButler simplify this process, increasing proper shoe cover compliance and minimizing cross contamination. Both provide hands-free application and removal in seconds. Shoe cover refill bundles at TerraUniversal.com

KineticButler Dispenser

	Cat. #	S/Each
Regular Capacity*	3619-01	315.00
High Capacity**	3619-00	788.00

BootieButler Remover

	Cat. #	S/Each
Regular Capacity*	3619-03	2,495.00
High Capacity**	3619-02	3,068.00

* Holds 55 pairs of one shoe cover bundles (applicator) / 500 pieces (remover)

** Holds 110 pairs of two shoe cover bundles (applicator) / 1,000 pieces (remover)



Item	Dimensions W" x D" x H"	Acrylic		Static Dissipative PVC		Polypropylene	
		Cat. #	S/Each	Cat. #	S/Each	Cat. #	S/Each
A. Sneeze Guard	7.125 x 1.75 x 7.75	1601-50	16.00	1601-51	26.00	—	—
Sneeze Guard	11 x 1.625 x 11	1600-25	19.00	1602-75	29.00	—	—
B. Dispensing Bin	5 x 8 x 11.65	4950-12	149.00	4950-13	259.00	4952-06	258.00
C. Mini-Hood	20 x 12 x 16	4950-89	433.00	4950-90	693.00	4952-00	691.00
D. Balance Shield	12.25 x 13 x 12	4950-55	183.00	4950-56	277.00	—	—
E. Micro-Desiccator Storage Cabinet	9 x 11 x 8.5	4950-06	444.00	4950-08	705.00	4952-01	673.00
F. Tissue Box Holder	5.5 x 5.75 x 3.125	4950-41	19.00	4950-42	28.00	—	—
F. Tissue Box Holder	5 x 5.125 x 4.125	4005-53	28.00	4005-54	34.00	—	—
F. Tissue Box Holder	5.5 x 15 x 4.25	4950-43	40.00	4950-44	48.00	—	—
G. Pigeon Hole Organizer	16 x 16 x 7.5	4005-22	142.00	—	—	—	—
H. Safety Glasses Dispenser	6.75 x 5.75 x 17	4950-45	282.00	4950-46	354.00	4952-10	372.00
I. Clip Board, Electropolished SS	12 x 9.5	1350-00A-2	59.00	—	—	—	—



A Models for loose or packaged gloves



B



C

F

G

Stainless Steel Glove Dispensers –Electropolished 304 (316 SS available) by Terra

	Description	Dimensions W" x D" x H"	Cat. #	S/Each
A	Glove Dispenser Wall-mount	8 x 8 x 24 (1 Compartment)	4951-37-2	485.00
	Glove Dispenser Wall-mount	16 x 8 x 24 (2 Compartments)	4951-38-2	930.00
	Glove Dispenser Wall-mount	24 x 8 x 24 (3 Compartments)	4951-32-2	1,172.00
	Glove Dispenser Wall-mount	34.5 x 8 x 24 (4 Compartments)	4951-33-2	1,489.00
B	Bagged Gloves Dispenser Wall-mount	24.5 x 7.5 x 24 (2 Compartments)	4951-43-2	956.00
	Bagged Gloves Dispenser Wall-mount	34.5 x 7.25 x 24 (3 Compartments)	4951-44-2	1,187.00
	Bagged Gloves Dispenser Wall-mount	27 x 7 x 24 (3 Compartments)	4951-30-2	1,129.00
	Bagged Gloves Dispenser Wall-mount	34.5 x 8 x 24 (4 Compartments)	4951-31-2	1,489.00
C	Bagged Gloves Dispenser Wall-mount	27 x 8.25 x 24 (4 Compartments)	4951-46-2	1,426.00
	Glove Dispenser with Waste Bin	24 x 18.5 x 59 (3 Compartments)	4951-34-2	2,442.00
	Glove Dispenser with Waste Bin	31.5 x 18.5 x 63 (4 Compartments)	4951-39-2	2,962.00
D	Glove Dispenser (not shown)	12 x 6 x 6	4951-50-2	131.00
E	Glove Dispenser (not shown)	5.75 x 3.875 x 11 (1 box)	4951-53-2	60.00
F	Glove Dispenser	12 x 3.75 x 11 (2 boxes)	4951-54-2	66.00
G	Glove Dispenser	18 x 3.75 x 11 (3 boxes)	4951-55-2	84.00
H	Glove Dispenser (not shown)	5.75 x 3.875 x 22 (2 boxes)	4951-51-2	67.00
I	Glove Dispenser (not shown)	5.75 x 3.875 x 33 (3 boxes)	4951-52-2	74.00



Benchtop option for item A, No. 4951-90-2

A

PLASTIC GLOVE DISPENSERS



A Polypropylene



B



C



D Polypropylene

Acrylic, Static Dissipative PVC and Polypropylene Glove Dispensers by Terra

	Glove Dispenser	Dimensions W" x D" x H"	Acrylic		Static Dissipative PVC		Polypropylene	
			Cat. #	S/Each	Cat. #	S/Each	Cat. #	S/Each
A	Wall Mount (3 Chamber)	16 x 11.5 x 12	4005-56	286.00	4005-57	432.00	4952-03	471.00
B	Wall Mount	16.5 x 12.5 x 17	4950-72	257.00	4950-74	347.00	4952-02	382.00
C	Plastic Boxed Gloves Holder	5.125 x 11.5 x 4.88	4950-85	56.00	4950-86	93.00	—	—
D	Benchtop	12 x 6 x 6	4951-03	89.00	4951-04	134.00	4952-04	133.00



More sizes available –
www.TerraUniversal.com

A. Super Adjustable™ Wire Shelves

Just lift the release on each corner, adjust your shelf at precise 1-inch increments, and clamp the release lever shut. In seconds, you can optimize your storage system to changing load requirements, with no tools, no wasted time, and no wasted space. For shelf grounding in static-sensitive applications, select conductive sleeves below.

A. Super Adjustable Wire Shelves

Dimensions W x L (inches)	Chrome Plated		Stainless Steel	
	Cat. #	S/Each	Cat. #	S/Each
18 x 24	1701-75	43.00	2650-35	150.00
18 x 36	1701-76	44.00	2650-37	152.00
18 x 48	1701-77	53.00	2650-39	179.00
18 x 60	1701-78	61.00	2650-41	227.00
21 x 24	1697-24	50.00	2650-43	171.00
21 x 36	1701-79	52.00	2650-45	173.00
21 x 48	1701-80	60.00	2650-47	199.00
21 x 60	1697-28	69.00	2650-49	264.00
24 x 24	1701-81	53.00	2650-51	184.00
24 x 36	1701-82	56.00	2650-53	187.00
24 x 48	1701-83	64.00	2650-55	225.00
24 x 60	1701-84	76.00	2650-57	274.00

	Cat. #	S/Pkg.
Replacement Sleeves/Wedges (pack of 4)	1571-00	5.00
Conductive Sleeves (pack of 4)	1571-01	5.00

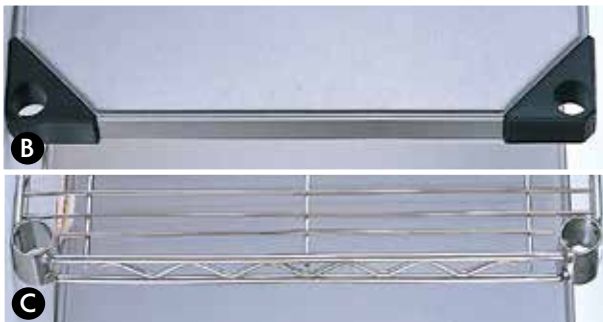

B. – C. Cleanroom Shelving with Split-Sleeve Assembly

This InterMetro shelving is fabricated of noncontaminating, cleanroom-compatible materials. Order aluminum split sleeve for shelf grounding.



B. Solid Shelves

Dimens. W x L (in)	Flat Stainless Steel		Chrome Plated		Stainless Steel	
	Cat. #	S/Each	Cat. #	S/Each	Cat. #	S/Each
18 x 24	1301-06	143.00	1300-35	40.00	1300-64	147.00
18 x 36	1301-08	152.00	1300-37	40.00	1300-66	148.00
18 x 48	1301-10	186.00	1300-39	49.00	1300-68	176.00
18 x 60	1301-11	226.00	1300-40	57.00	1300-69	223.00
21 x 24	1301-12	170.00	1300-42	46.00	1300-71	168.00
21 x 36	1301-14	172.00	1300-44	48.00	1300-73	170.00
21 x 48	1301-16	211.00	1300-46	56.00	1300-75	196.00
21 x 60	1301-17	254.00	1300-47	64.00	1300-76	260.00
24 x 24	1301-18	182.00	1300-49	48.00	1300-78	181.00
24 x 36	1301-20	186.00	1300-51	52.00	1300-80	183.00
24 x 48	1301-22	224.00	1300-53	61.00	1300-82	213.00
24 x 60	1301-23	273.00	1300-54	72.00	1300-83	270.00

C. Wire Shelves

SiteSelect™ Posts

Height (inches)	Stationary				*Mobile			
	Chrome Plated		Stainless Steel		Chrome Plated		Stainless Steel	
	Cat. #	S/Each	Cat. #	S/Each	Cat. #	S/Each	Cat. #	S/Each
14.5	1300-85	10.00	1300-91	21.00	—	—	—	—
34.5	1300-86	12.00	1300-92	32.00	1307-98	13.00	2650-01	31.00
54.5/62.5	1300-87	20.00	1300-93	36.00	1307-90	14.00	2650-02	36.00
62.5/62.5	1300-88	16.00	1300-94	40.00	1307-91	15.00	2650-30	38.00
74.6/25	1300-89	19.00	1300-95	45.00	1307-92	16.00	2650-03	44.00
86.6/25	1300-90	21.00	1300-96	53.00	1307-93	21.00	2650-04	52.00

* Make it mobile – Select the mobile post from chart above. Casters available at TerraUniversal.com

Plastic Split Sleeve Assembly

Included with each shelf.

Aluminum Split Sleeve

For grounding type B/C shelves.

Cat. #	S/Pkg.
1303-70	8.00



Wall-Mount Shelving

Order quantities indicated below to create an above-bench storage unit. Posts are 33.6"H and allow shelf adjustment. Metroseal 3 coating inhibits growth of bacteria, fungus and other microbes. Wall mounting hardware not included (varies according to wall type).

	Stainless Steel		Antimicrobial Metroseal 3	
	Cat. #	S/Each	Cat. #	S/Each
Shelves (2*)				
18"D x 36"L	1300-66	148.00	1300-98	52.00
18"D x 48"L	1300-68	176.00	1300-99	62.00
Shelf Supports (4*)	1306-74	53.00	1306-70	29.00
Shelf Posts (2*)	2650-10	75.00	2650-09	42.00

* Order quantity indicated in parenthesis to create one shelving unit

Designed for modular use, these easy to assemble stainless steel tables allow users to add and/or change components as need arises. The smooth surface and rounded corners allow easy cleaning and the tapered sleeve design and the double-sided tape are ideal for affixing various top materials.

- Load rated at 50 lbs. per sq. foot and up to 600 lbs. maximum
- All-stainless steel shelves and high-temperature casters allow cart wash and enable autoclave applications
- Casters and accessories sold separately

A. Stainless Steel Lab Table

A. Stainless Steel Lab Tables and 3-Sided Frame

Dimensions L" x W" x H"	Weight lbs.	Cat. #	S/Each
29.75 x 30 x 35.375*	58	1533-82	875.00
35.75 x 30 x 35.375	70	1533-83	975.00
47.75 x 30 x 35.375	91	1533-84	989.00
59.75 x 30 x 35.375	119	1533-85	1,112.00

*Tray and drawer are not available for #1533-82



Optional shelf, drawer, keyboard tray and monitor arms

B/C. Stainless Steel Tables with Backsplash

Models are equipped with a backsplash to protect on-top instruments, equipment and testing items.

B. Stainless Steel Lab Tables and 3-Sided Frame

Dimensions L" x W" x H"	Cat. #	S/Each
29.75 x 30 x 35.188*	1533-70	924.00
35.75 x 30 x 35.188	1533-71	1,027.00
47.75 x 30 x 35.188	1533-72	1,044.00
59.75 x 30 x 35.188	1533-73	1,112.00

*Tray and drawer are not available for #1533-70 and #1533-66

A



Three-sided frame with backsplash and optional wire shelf



With backsplash and shelf

C. Stainless Steel Worktable with Backsplash and Shelf

Dimensions L" x W" x H"	Cat. #	S/Each
29.75 x 30 x 39.5*	1533-66	781.00
35.75 x 30 x 39.5	1533-67	816.00
47.75 x 30 x 39.5	1533-68	860.00
59.75 x 30 x 39.5	1533-69	895.00

*Tray and drawer are not available for #1533-70 and #1533-66

B

C

D. – F. Designed for ISO 7 or Class 10,000 cleanliness, these cleanroom or lab tables have a seamless 304 stainless steel work surface supported by 11-gauge nickel/chrome-plated channel supports.



Stainless Steel Bottom Shelf



Stainless Steel Bottom 3-sided Frame



Stainless Steel Bottom H-Frame

Cleanroom/Lab Tables

Type	Length inches	Post Material	Width 30 Inches		Width 36 Inches		Width 44 Inches	
			Cat. #	S/Each	Cat. #	S/Each	Cat. #	S/Each
D	60	SS	1305-00	956.00	1305-18	1,098.00	1305-54	1,238.00
	72	SS	1305-01	1,033.00	1305-19	1,178.00	1305-55	1,321.00
	96	SS	1305-02	1,261.00	1305-20	1,418.00	1305-56	1,569.00
E	60	SS	1305-06	792.00	1305-24	924.00	1305-60	1,060.00
	72	SS	1305-07	863.00	1305-25	1,039.00	1305-61	1,136.00
	96	SS	1305-08	1,029.00	1305-26	1,217.00	1305-62	1,318.00
F	60	SS	1305-12	792.00	1305-30	959.00	1305-66	1,060.00
	72	SS	1305-13	863.00	1305-31	1,039.00	1305-67	1,136.00
	96	SS	1305-14	1,029.00	1305-32	1,217.00	1305-68	1,318.00



A *Three-Shelf Cart (No. 1532-53A)
Microban® Antimicrobial
Formulation Available!*



B *Three-Shelf Deep-Ledge Cart
(No. 1532-57)
Microban® Antimicrobial
Formulation Available!*

A. Polymer Utility Carts with Adjustable Shelves

These carts by Metro will never corrode and the ergonomic handle provides more walking space between you and the cart during transport. The trays offer twice the amount of space and the ship's edge prevents items from sliding when cart is mobile. Two-tier and three-tier models are available in blue, black and gray. Load capacity: 150-500 lbs.

2-Shelf Models W" x L"		Blue	
	Cat. #		\$/Each
18 x 28	1532-12A		151.00
21.5 x 33.75	1532-47A		163.00
27 x 39.5	1532-13A		190.00
3-Shelf Models W" x L"		Blue	
	Cat. #		\$/Each
18 x 28	1532-14A		176.00
21.5 x 33.75	1532-53A		199.00
27 x 39.5	1532-15A		232.00



C *Series 100 – Two stainless steel solid shelves (see chart below)*



D *Series 200 – Three stainless steel solid shelves (see chart below)*

B. Polymer "Deep Ledge" Carts with Adjustable Shelves

Similar to models above, but with 2.75" (70 mm)-deep shelf ledges for enhanced spill containment. All models are 41"H. Color: blue.

W" x L"	Configuration	Cat. #	\$/Each
21.5 x 32.75	2-shelf	1532-56	170.00
21.5 x 32.75	3-shelf	1532-57	209.00
27 x 38.75	2-shelf	1532-58	199.00
27 x 38.75	3-shelf	1532-59	244.00

Dozens more at TerraUniversal.com!



E *Series 400 – Two chrome wire shelves and one stainless steel solid shelf.*



F *Series 600 – Two wire shelves, chrome or stainless steel.*



G *Series 700 – Shown with optional bin. Three wire shelves, in a choice of chrome or stainless steel.*

Ordering Information		C. Series 100		D. Series 200		E Series 400		F. Series 600		G. Series 700	
Dimensions W" x L" x H"	Caster Dia.	Cat. #	\$/Each	Cat. #	\$/Each	Cat. #	\$/Each	Stainless Steel Wire Shelves		Stainless Steel Wire Shelves	
18 x 24 x 38	4"	1401-23	440.00	1401-44	589.00	1401-54	293.00	1402-39	413.00	1402-56	559.00
18 x 30 x 38	4"	1401-24	498.00	1401-45	650.00	1401-55	332.00	1402-41	471.00	1402-58	619.00
18 x 36 x 38	4"	1401-25	498.00	1401-46	650.00	1401-56	332.00	1402-43	471.00	1402-60	619.00
21 x 36 x 39	5"	1401-26	539.00	1401-47	710.00	1401-57	362.00	1402-45	527.00	1402-62	696.00
24 x 36 x 39	5"	1401-27	569.00	1401-48	755.00	1401-58	381.00	1402-47	556.00	1402-64	738.00

Moving? Take your lab with you!

Starsys lets you choose from an array of modular, mobile units to fit your changing work and space requirements.

- Fast, efficient lab installation
- Easy reconfiguration
- Flexible door, drawer and cabinet designs
- Corrosion-proof, noncontaminating polymer construction
- Greater storage density in a smaller footprint



Visit TerraUniversal.com for complete information!

NITROGEN and DRY AIR GENERATORS



Terra's gas generators and gas dryers provide several ways to produce a dry, particle-free environment inside glove boxes, desiccators, and other enclosures.

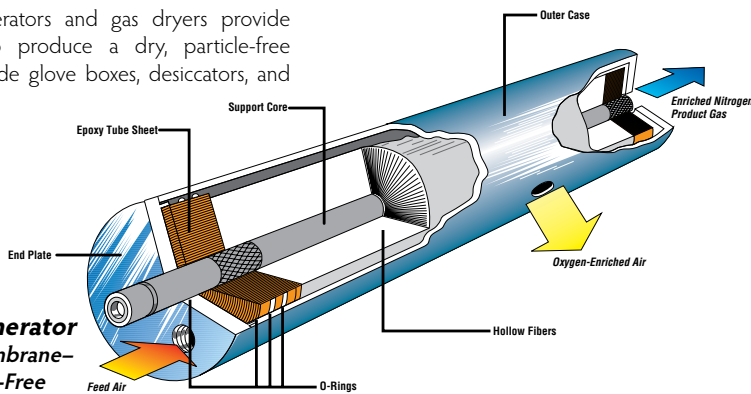

Nitrogen Generator
Separation Membrane—Reliable, Hassle-Free Nitrogen Source!

Nitrogen Generators

Purity vs. Flow Rates
(@100 psi inlet feed, 72°F*)

	Purity:	99%	98%	97%
No. 2700-12A	7.4 CFH	10.2 CFH	12.5 CFH	
No. 2700-11A	49.0 CFH	65.0 CFH	75.0 CFH	
No. 2700-09A	126.0 CFH	180.0 CFH	223.0 CFH	

* Higher flow rates can be achieved with higher feed temperature (see Terra's process gas heater, No. 9450-00).



Comparative Guide to Terra Gas Dryers

Product	Design Type	Outlet Flow Capacity	Service Requirement	Prefilters Included	Overall Dimensions (WxDxH)	Recommended Application	Cat. #	\$/Each
A. Nitrogen Generator	Membrane	See performance chart	Air Compressor (#9505-47)	Yes (micro-fiber & coalescing)	18 x 18 x 81.25	Gloveboxes, desiccators & N ₂ based process equipment in labs where N ₂ is preferable to dry air	2700-09A	14,452.00
					24 x 12 x 49.25		2700-11A	6,344.00
					20 x 12 x 35.5		2700-12A	5,070.00
B. Dryex 80™ Gas Dryer	Membrane	420-900 SCFH	Air Compressor (#9505-43)	Yes (micro-fiber & coalescing)	24 x 12 x 49.25	Low-humidity applications (in gloveboxes or desiccators) where clean, dry air is acceptable	9082-00	4,954.00
C. Dryex 10™ Generator	Membrane	54-105 SCFH @ 100 psig	Air Compressor (#9505-43)	Yes (micro-fiber & coalescing)	16x 7.25 x 6.5	Ideal source of purged gas in moisture-sensitive storage and processing applications	9082-01	2,570.00

WET PROCESSING and CLEANING CABINETS



Polypropylene stations are ideal for acids and caustic chemistries (shown with optional gooseneck faucets, spray guns, casters and duplex power outlets)

Fire-retardant polypropylene available!

- Incorporates all processing components into one self-contained, easy-to-clean system
- Isolated control panel allows safe, convenient operation of baths, rinsers, and other process modules
- Select all-polypropylene or stainless steel shell
- Standard system includes sliding access shield and fluorescent illuminator
- Custom engineered to meet specific application requirements!



Stainless steel processing cabinets are recommended for solvents and flammable chemicals (shown with optional casters and spray gun)

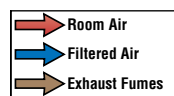
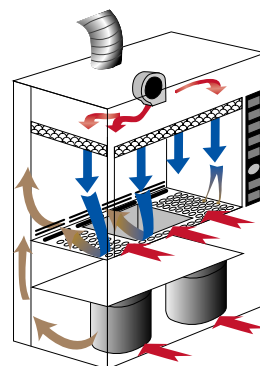

WET PROCESSING ACCESSORIES

- A. Process Baths and Rinsers
- B. Sinks
- C. Nitrogen and DI Water Spray Guns
- D. Gooseneck Faucets
- E. Aspirators
- F. Glove Washers

Call to discuss special requirements—

- FM4910 and other specialty plastics
- PLC automation
- SEMI S2/S8 and other certifications
- Chemical handling systems

MODULAR WET PROCESSING and CLEANING CABINET



QuickQuote Planner
quickly configures a system to your specifications: www.TerraUniversal.com



Standard Wet Bench, shown with Vertical Laminar Flow Hood and optional faucet and spray guns.

Stainless Steel Solvent Cleaning Bench

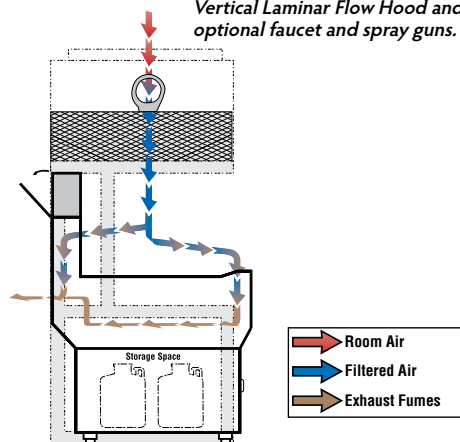

- Benches accommodate a complete line of baths, rinsers, cleaners, and other processing modules
- All polypropylene models are compatible with most acids and other process chemistries.
- Stainless steel models are suitable for solvent cleaning applications.
- Select among these standard configurations:

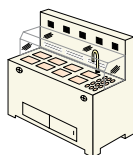

Standard Wet Bench

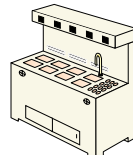

Standard Wet Bench with overhead control case

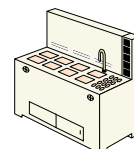

Standard Wet Bench with side control case

G – I. Acid Transport Carts

Made of stress-relieved polypropylene, these carts resist acids and corrosives used in wet processing applications. All three designs feature recessed receptacles that collect spills into an easy-empty containment reservoir. Acid-resistant neoprene swivel casters are included.

Type G features removable 7" x 7" inserts

Type H is ideal for larger, heavy containers. Compartments: two @ 17" x 26.5" x 17" and two @ 17" x 36.5" x 14"

Type I features 24 angled 7" x 7" slots for one-gallon bottles and one top compartment for gloves, safety glasses and other small items.

Polypropylene Acid Transport Carts

Type (see photos)	No. of Compartments	Cat. #	\$/Each
G	12	3401-00	2,384.00
H	18	3401-01	2,883.00
I	4	3401-30	2,630.00
	25	3401-31	3,386.00
Floor-Lock Brake		Cat. #	\$/Each
		3401-04	188.00





A. Barnstead™ MicroPure™ System

The compact units are ideal for producing ultrapure water for molecular biology, microbiology and analytical chemistry labs. They produce 15 liters/day of Type 1 water and are available with mix-and-match system option for UV, UF, UV/UF treatment.

	Cat. #	\$/Each
Analytical and UV System	3614-91	3,375.00
UV-ST System	3614-96	3,531.00

(Includes integrated 6 L feed water tank)

B. B-Pure Cartridge Systems

Provides point-of-use deionization for laboratories and other facilities requiring pure water. The flexible design allows configuration to meet your water needs. Accepts most Thermo Scientific Barnstead cartridges and filters (ordering information at Laboratory-Equipment.com).

	Cat. #	\$/Each
Single Holder	3613-52	366.00

C. Barnstead GenPure™ Water Purification System

Able to mix and match UF, UV and TOC systems for user-specific water purity levels, the GenPure system produces up to 200 L/day of GLP-compliant Type 1 ultrapure water from a pretreated feed water supply. It is ideal for a broad range of life sciences and analytical chemistry processes.

	Cat. #	\$/Each
GenPure Water System	1714-32	5,049.00
GenPure UF Water System	1714-33	5,507.00

(Includes Ultra-Filtration; ideal for molecular biology, microbiology, PCR, IVR and monoclonal antibody processes)

D. GenPure xCAD Water Purification System

Includes all the features of the GenPure system above, plus remote dispensing, electronic dosing capabilities, and flexible mounting options.

	Cat. #	\$/Each
GenPure xCAD Water System	1714-48	5,890.00
GenPure xCAD UF Water System	1714-49	6,214.00

(Includes Ultra-Filtration; ideal for molecular biology, microbiology, PCR, IVR and monoclonal antibody processes)

E. LabTower™ TII Water Purification System

This system converts tap water into GLP-compliant Type 2 water; choose 20 L or 20 L/hr. models. This stand-alone unit with casters has an integrated 100 L tank that recirculates reservoir water to preserve purity even during periods of stagnation. Optional UV light eliminates bacteria. More configurations and specifications.

	Cat. #	\$/Each
LabTower TII System, 20 L/hr.	1108-50	8,327.00
LabTower TII System, 40 L/hr.	1108-52	9,076.00

F. LabTower EDI Water Purification System

Two stand-alone systems in one. These models produce either Type 1 (up to 200 L/day) or Type 2 (up to 500 L/day) purified water. Includes high-performance RO module with Electrodeionization (EDI) technology. Integrated 100-liter tank recirculates Type 2 water to optimize purity.

	Cat. #	\$/Each
LabTower EDI System, 15 L/hr.	1714-60	11,546.00
LabTower EDI System, 30 L/hr.	1714-61	13,210.00



For vapor removal, see ventilation module at TerraUniversal.com

No. 2820-00A and No. 2800-00A



Sure-Grip® EX Safety Can Storage Cabinets

Designed to meet OSHA and NFPA standards, these cabinets are sturdily constructed of all-welded, 18-gauge, double-walled steel with 1.5" of insulating air space for fire resistance. They include spill-slope safety shelves adjustable on 3" centers and dual vents with built-in arresters. All models shut and latch automatically when fusible links melt at 165°F (74°C) under fire conditions. Patented, concealed closing mechanism in self-close style maximizes available shelf space and minimizes risk of damage to the mechanism.

U-Loc™ padlockable paddle handle with slip resistant grip offers easy fingertip operation and reduces dangerous "catches" from passing traffic. Haz-Alert™ reflective labeling bursts with high visibility when illuminated by a flashlight beam, ensuring visibility of hazardous warning message. Sturdy galvanized steel SpillSlope™ shelves safely direct incidental spills to the back and bottom of the leak-proof sump. Includes leveling feet, grounding connector, and hazard warning in three languages. Backed by a 10-year warranty.

Capacity (gal.)	Dimensions (W x D x H)	Approval Listing*	Doors/Type	Cat. #	\$/Each
30	43" x 18" X 44"	FM, N, O	2 / manual	2800-00A	530.00
30	43" x 18" X 44"	FM, N, O, U	2 / self-closing	2820-00A	602.00
45	43" x 18" X 65"	FM, N, O	2 / manual	2820-02A	665.00
45	43" x 18" X 65"	FM, N, O, U	2 / self-closing	2820-03A	736.94
60	34" x 34" X 65"	FM, N, O	2 / manual	2820-05A	802.00
60	34" x 34" X 65"	FM, N, O, U	2 / self-closing	2820-06A	872.00

* See Approval Key

Corrosive Storage Cabinets

These steel cabinets feature a two-part enamel coating which has been tested successfully with widely used acids, caustics, and alkalines, such as hydrochloric acid 37%, sulfuric acid 33%, and sodium hydroxide. This surface will not allow absorption that could cause subsequent problems. The 22-gallon model is an Under-the-Counter Cabinet, with polypropylene-lined bottom and top, and a 0.75-inch tray top, which can completely contain a 5-pint spill. The other three models, which are floor-mounted, feature corrosive-resistant polyethylene trays, to contain spills, on the bottom and on the shelves.

Approval Key

FM Factory Mutual tested and approved
 N National Fire Protection Association (NFPA) code 30
 O Complies with OSHA regulations
 U Complies with Uniform Fire Code

Capacity (gal.)	Dimensions (W x D x H)	Approval Listing*	Doors/Type	Cat. #	\$/Each
30	43" x 18" X 44"	FM, N, O	2 / manual	2820-09A	627.00
45	43" x 18" X 65"	FM, N, O	2 / manual	2820-10A	741.00
45	43" x 18" X 65"	FM, N, O, U	2 / self-closing	2820-11A	830.00
22	35" x 22" x 35"	FM, N, O	2 / manual	2820-12A	600.00

* See Approval Key

Enclosed Safety Shower

- Provides full-body shower and eye wash while protecting lab against water and chemical splashes
- Polypropylene enclosure resists most lab acids and corrosives
- Easy-parting transparent vinyl curtain allows fast, convenient access while shielding the external environment
- Immediate-response operation handles are easy to activate

Terra's safety shower combines easy, reliable operation with a fully enclosed design that enhances safety both inside and outside the shower area.

The polypropylene shell resists most laboratory acids and corrosives. By shielding the shower on three sides, it minimizes the chance of the water spray—or of harmful chemical splashes—affecting parts or personnel outside the shower. The 40 mil overlapping vinyl strip curtain on the front is easily parted for quick entry into the enclosure.

All eye rinsing hardware is zinc-plated. The standard overhead nozzle height is 78" off the shower floor; the eye rinsers are positioned 42" off the floor. The shower comes complete with PVC plumbing that connects to your in-house water supply by means of a 1.25" ID pipe fitting. The sloping bottom feeds into a 2.5" drain line. Dimensions: 38"W x 41"D x 90"H. Complete specifications at TerraUniversal.com.

Cat. # **1530-50** \$/Each **3,433.00**



CLEANING



Ultrasonic Cleaners

Available in digital and manual series with five capacity sizes to choose from, these ultrasonic cleaners provide thorough, safe cleaning of small and medium-sized parts. Features on select models include heating and timer configurations and degas functions. Models meet CE, UL, CSA and FCC regulations and standards. (#2631-00A Shown)

Tank Capacity	Cat. #	S/Each
0.5 gallons	2631-00A	555.00
0.75 gallons	2617-00A	731.00
1.5 gallons	2618-00A	1,077.00
2.5 gallons	2619-00A	1,433.00
5.5 gallons	2637-00A	2,480.00



Ionizing Blow-Off Gun

Safely removes surface contaminants with a burst of clean, static-neutralized air or nitrogen. Low-voltage design for safe, low-EMI/RFI operation. Includes 0.4-micron capsule filter.

Cat. #	S/Each
110VAC	
2005-55	660.00
Transformer 120Vac, 60Hz	
2005-09A	36.00
Transformer 240Vac, 50Hz	
2005-09A-220	47.00



SNO GUN™ II High-Precision Cleaner

The safe, inexpensive, highly effective alternative to solvent or dry nitrogen cleaning of sensitive parts! Dry ice particles remove contaminants as small as 0.1 micron without disturbing delicate surface features. Specialized inert gas enclosure available to prevent moisture condensation.

Cat. #	S/Each
4545-00A	2,074.00

VACUUM SEALERS



AV Vacuum Sealer With Gas Purge

The foot-pedal-activated, retractable nozzle AV series vacuum sealers offer gas-flush vacuum packaging at its finest. The 0.25"-wide sealing element delivers a leak-proof seal for electronic devices that require moisture barrier bags.

With one touch of the pedal, the AV flushes out oxygen and moisture with nitrogen, and your sensitive components are sealed in seconds. Also great for dry packaging applications and shipping containers. Compressed air required.

Seal Length	120VAC		220VAC	
	Cat. #	S/Each	Cat. #	S/Each
20"	4052-15*	1,692.00	4052-15-220*	2,081.00
20"	4052-19	2,114.13	4052-19-220	2,528.00
25"	4052-20	2,520.00	4052-20-220	2,959.00
30"	4052-21	2,752.00	4052-21-220	3,136.00
35"	4052-22	2,942.00	4052-22-220	3,314.00

* These models do not include the gas flush feature.



Digital Vacuum Sealers

Digital controls ensure repeatable, uniform sealing cycles. The standard cycle is gas-vacuum-seal; optional firmware change allows vacuum-gas-seal cycling. All units feature gas purge and have 0.25" seal elements. Three-year standard warranty.

Seal Length	120VAC, 50/60Hz		220VAC, 50Hz	
	Cat. #	S/Each	Cat. #	S/Each
15"	4053-01	1,706.00	4053-01-220	2,048.00
20"	4053-02	1,869.00	4053-02-220	2,113.00
25"	4053-03	2,234.00	4053-03-220	2,478.00
30"	4053-04	2,356.00	4053-04-220	2,730.00
35"	4053-05	2,559.00	4053-05-220	2,803.00

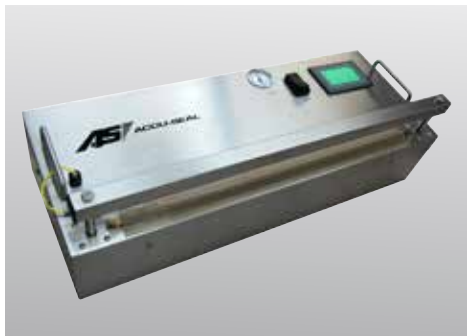

Validatable Accu-Sealers 5300 & 5400

Validatable Accu-Sealers give you absolute process control for validation, and provides uniform, reliable seals without the need for adjustment of machine settings in

a production run. Designed to meet cleanroom requirements and seals a wide range of medical packaging materials. The 5400 series has a built in air compressor for plug and seal performance.

Seal Length	5300 Series		5400 Series w/ Compressor	
	Cat #	S/Each	Cat #	S/Each
15"	4049-81	5,039.00		
20"	4049-82	5,266.00	4049-84	6,149.00
25"	4049-83	5,494.00	4049-85	6,306.00



Validatable Impulse Heat Sealer

The 6300 series is designed for repeatable and reliable medical sealing of pre-made pouch materials that meet cleanroom standards. The seamless stainless

steel case is easily sanitized and built for long lasting and low maintenance operation. It is 100% validatable and calibratable.

Seal Length	Cat #	S/Each
15"	4049-65	6,752.00
20"	4049-66	7,025.00
25"	4049-67	7,389.00
30"	4049-68	7,753.00
35"	4049-69	8,117.00



Nilfisk Cleanroom Vacuum Cleaner With ULPA Filtration

A four-stage filtration system, which includes a final ULPA filter, rated 99.999% efficient @ 0.12µm particles, and quiet operation (59 dBA at 6.5 feet) make this vacuum ideal for cleanroom use. Includes filter set and tool kit with two 22" stainless steel tubes, 3" round brush, combination 12" floor nozzle, 6'6" conductive plastic hose, trolley, 30' power cord, conductive crevice nozzle and 5" utility nozzle. Tank capacity: 3.25 gallons.

	Cat. #	\$/Each
120VAC	1764-00	1,134.00
240VAC	1764-00-220	1,156.00



Minuteman® CRV Vacuum

Ideal for ISO 3 – 8 facilities, this CRV features an electromagnetic/radio frequency interference filtration (RFI/EMI) for more stringent applications. The unit has a three-stage filtration system with a dual layer disposable paper bag, a non-woven cloth filter and a standard ULPA filter. The quiet motor supplies powerful suction at a constant airflow with a noise level of 65 dBA. The unit comes with a stainless steel four-wheel carriage for strength and mobility. Tank capacity: 4 gallons.

	Cat. #	\$/Each
115VAC	1001-65	1,369.00



Nilfisk SS Cleanroom Vacuum with Safe-Pak

Designed for cleanroom environments down to ISO 4 (Class 10), this compact and quiet cleanroom vacuum has the Safe-Pak function that effectively contains and disposes of hazardous materials. The multi-stage HEPA filtration system removes particles down to 0.12 microns at 99.999% efficiency. Safe-Pak can be interchanged with standard vacuum collection containers. Lightweight units are constructed with pharmaceutical standard AISI 316 stainless steel. Vacuum is easy to clean with autoclavable parts. Tank capacity: 3.25 gallons.

	Cat. #	\$/Each
110/120V	1764-37	2,029.00
Safe-Pak Replacement Collection Container	1764-43	354.00



Compact, Versatile MicroVac™ — Vacuum or Clear Air Blower

- Includes 99.999% efficient ULPA filter to capture sub-micron particulates
- Four-stage filtering system
- Ideal for cleaning up hazardous powders, pharmaceutical spills
- Ventilates bio cabinets, glove boxes and other small enclosures
- Provides burst of particle-free air to clean keyboards, PCBs and other delicate surfaces
- Mini-tool kit pinpoints small surface features

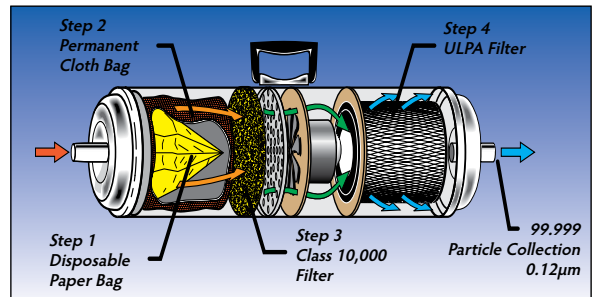

Triple-Duty Cleaning —

- Cleans up dust and chemical spills
- Clean air blower pinpoints ULPA-filtered air
- Ventilates glove box or other enclosure

MicroVac	Cat. #	\$/Each
110VAC/60Hz	5100-00	1,161.00
220VAC/50Hz	5100-00-220	1,282.00
MicroVac Tool Kit	5100-05	33.00
Replacement Filters		
Stage 1 Disposable Paper Bag	5100-01	89.00
Stage 3 Class 10,000 Filter	5100-02A	16.00
Stage 4 Class Replacement ULPA Filter	5100-04	173.00



Heratherm™ General, Advanced Protocol and Advanced Security Protocol Ovens

by *Thermo Scientific*

Gravity and mechanical convection modes in benchtop or floor standing models are available in a wide range of sizes. **Mechanical convection** models provide fast sample drying and heating, superior temperature uniformity and quick temperature recovery. Gravity convection models provide gentle drying and heating with low air turbulence.

- Stackable with adjustable shelves
- Rounded inside corners for easy cleaning
- Microprocessor control
- Automatic overtemperature alarm
- Easy calibration routine
- RS232 interface

A. General Protocol Ovens

Routine heating and drying up to 250°C

- Material: Stainless steel
- Manually controlled fresh air damper
- On/Off timer functions

B. Advanced Protocol Ovens

Accurate and heating up to 330°C

- Adjustable fan speed: 2-5
- Electronically controlled fresh air damper
- Flexible timer functions; programmable features
- Access port for data monitoring

C. Advanced Protocol Security Ovens

Safety features protects samples

- Adjustable fan speed: 5
- Undertemperature alarm, door alarm, lockable door, connection for optional sample temperature sensor
- Optional stainless steel exterior

	Type	Range	Cat. #	\$/Each
A	Gravity, 120 V, 66 L	50° to 250°C	3700-87	1,585.00
	Mechanical, 120 V, 66 L		3700-90	1,849.00
B	Gravity, 120 V, 61 L	50° to 330°C	3700-93	2,025.00
	Mechanical, 120 V, 61 L		3700-96	2,467.00
C	Gravity, 120 V, 61 L	50° to 330°C	3616-40	2,114.00
	Mechanical, 120 V, 61 L		3616-49	2,658.00



Large Capacity Forced-Air Multi-Purpose Ovens by Shel Lab

Ideal for glassware drying and high volume sample and production processes, these ovens have excellent temperature uniformity and fast recovery.

- Temperature Range: Ambient +15°C to 260°C
- Material: Stainless steel interior
- Includes stainless steel shelves
- Exhaust port, digital timer, independent overtemperature safety, wrap-around insurable, high-temperature silicone door seal

Capacity, 240 V	Cat. #	\$/Each
14 cu ft./three shelves	3700-85	3,494.00
28 cu ft./six shelves	3700-86	4,920.00



Class 100 Cleanroom Ovens by Thermo Scientific

Used for cleanroom, semiconductor and electronics applications, these units provide excellent temperature control and uniform heating.

- Repeatable temperature settings from ambient +5° to 250°C
- Material: Stainless steel interior
- Non-filtered models meet ISO 5 requirements; HEPA-filtered models exceed ISO 5 conditions
- Four program controller with 16 segments

Capacity	240 V	Cat. #	\$/Each
14 cu ft./three shelves	With HEPA Filter	3700-70	9,596.00
28 cu ft./six shelves	w/out HEPA Filter	3700-15	7,649.00



Vacuum Ovens by Thermo Scientific

Designed for desiccating, vacuum embedding, plating and electronic component processing applications, these models are available with two control and display options.

- Temperature Range: Ambient +10° to 220°C
- Material: Stainless steel interior
- Independent vacuum and purge needle valves; radiant warm-wall heating

Capacity	120 V	Cat. #	\$/Each
14 cu ft./three shelves	Dial Thermometer	3700-35	2,803.00
28 cu ft./six shelves	LED Readout	3700-80	2,878.00

Heated and Humidified Incubators by Caron

These energy-efficient benchtop and floor-standing models provide consistent and precise controlled conditions in research processes. .

- Material: Stainless steel
- Temperature range/control: 10°C above ambient to 70°C/ ±0.1°C
- Temperature uniformity: ±0.3°C
- **gVapor™** delivers controlled humidity vapor as needed
- **gROD™** for energy savings; high R, CFC-free foam insulation
- **gLux™** Fluorescent Lighting System simulates day/night conditions
- Application: General laboratory research, life science

Model	Shelves Included/Max	Capacity cu. ft.	115 V, 60 hz	
			Cat. #	S/Each
Heated	3/15	10	5757-36	7,887.00
Humidified*	3/15	10	5757-37	10,071.00
Heated	4/25	25	5757-38	8,727.00
Humidified*	4/25	25	5757-39	10,799.00
Heated	5/31	33	5757-40	10,071.00
Humidified*	5/31	33	5757-41	12,255.00

* Humidified models feature gVapor energy efficient delivery of controlled humidity vapor (as needed)



33 cu. ft.

25 cu. ft.

10 cu. ft.

Midi™ 40 Small Capacity CO₂ Incubator by Thermo Scientific

These compact and stackable units feature a comprehensive advanced microprocessor system for safe and efficient operation. Designed for cell culture scientists, these models deliver what bigger incubators do at a cost-effective price point and in a space-saving footprint.

- Exterior Dimension: 18.5"W x 23.5"D x 18"H
- Interior Dimension: 12.2"W x 14"D x 14"H
- Material: stainless steel
- Advanced IntrlLogic™ II microprocessor
- Factory calibration maintains accurate thermal gas performance
- Comprehensive alarm system
- Temperature range: 5°C above ambient to 60°C
- Temperature control ±0.1°C
- Includes: four stainless steel removable shelves
- Application: cell culture

Capacity	Temp. Range	CO ₂ Concentration Range	Cat. #	S/Each
1.4 cu. ft.	5° to 60°C	0 to 20%	3615-78	4,414.00



Stores up to 35 T75 culture flasks

myTemp™ Mini Digital Incubators by Benchmark Scientific

Easy-to-use and compact, these transportable digital incubators immediately begin to heat once desired temperature is set. The LED display shows the chamber temperature in real time.

- Exterior Dimensions: 13.2"W x 14.5"D x 18.7"H
- Interior Dimensions: 10.3"W x 9.3"D x 12.8"H
- Digital temperature control and large LED display
- Accepts bottles and flasks up to 2 L
- Transparent door
- Convenient carrying handle
- Includes two adjustable removable shelves

Universal Voltage with US plug			
myTemp	Temperature	Cat. #	S/Each
Heat Only	Ambient +1°C to 60°C	BR18-00	390.00
Heat and Cool	Ambient -15°C to 60°C	BR18-01	548.00





Small, silent and powerful with an 8-position microtube rotor

myFuge™ Mini by Benchmark Scientific 8 Position Microtube Rotor

With twice the capacity of most mini centrifuges, the myFuge instantly reaches 6,000 rpm once the lid is closed and quickly stops once the lid is open. Models are ideal for personal use or for quick spindowns of microtubes and PCR tubes. The unit comes with an installed eight-position microtube rotor and the second PCR 0.2 ml rotor is conveniently stored in the bottom compartment.

- 8-position microtube rotor for increased productivity
- Capacity: 8 x 1.5 / 2.0 ml tubes; 16 x 0.2 ml PCR tubes; 2 x 0.2 ml PCR strips
- Speed: 6000 rpm/2000 x g
- Dimensions: 4.5"W x 5.9"D x 4.5"H
- Electrical: 120 - 240V, 50/60 hz
- Includes microtube rotor, PCR rotor, 0.5 ml & 0.2 ml adapters



CE Listed units available in five colors

Color	Cat. #	S/Each
Red	BR04-05	218.00
Blue	BR04-06	218.00
Clear	BR04-07	218.00
Green	BR04-08	218.00
Purple	BR04-09	218.00



myFuge™ 12 Mini Centrifuge 12 x 15/2 ml Tubes Capacity

Ideal for quick spin-downs, the myFuge™ 12 by Benchmark Scientific has a silent operation and a lid-operated COMBI-Rotor that eliminates rotor changes when switching between microtubes and PCR Strips.

- Capacity: 12 x 15/2.0 ml tubes; 32 x 0.2 ml tubes; 4 x PCR strips (8 x 0.2 ml)
- Speed Range: 5500 rpm/2000 x g
- Dimensions: 5.5"W x 7.9"D x 4.4"H

115V plug	Cat. # BR15-00	S/Each 293.00
-----------	--------------------------	-------------------------



StripSpin™ 12 Mini Centrifuge 4 x 12 Position PCR Strip Capacity

These silent and compact units by Benchmark Scientific are ideal for quick spindowns of samples. Units feature a lid-operated spinning rotor that quickly spins samples at 5500 rpm when lid is closed. Open the lid to begin deceleration.

- Capacity: 4 x PCR strips (8- or 12- position) or 48 x individual 0.2 ml PCR tubes
- Fixed speed: 5500 rpm/2000 x g
- Dimensions: 5.5"W x 7.9"D x 4.4"H

115V plug	Cat. # BR19-25	S/Each 360.00
-----------	--------------------------	-------------------------



Medilite™ Centrifuge 6-Place or 12-Place Rotor Capacity

High-performance and cost-effective units by Thermo Scientific have safety features that protect the user when performing routine, low-speed applications of blood and urine separations.

- 6-Place Rotor Capacity: 90 ml (6 x 15 ml)
- 12-Place Rotor Capacity: 120 ml (12 x 10 ml)
- Max Speed: 3100/2700 rpm
- Max RCF: 1228/920 x g
- CE marked, CSA approved (select models)

6-Place Rotor Capacity	Cat. # 3615-71	S/Each 901.00
12-Place Rotor Capacity	3615-73	1,006.00



MaxQ 5000 Incubated Floor Shaker
Analog or digital shaker is foot pedal-operated
 Perfect for cell cultures, solubility studies, extraction procedures and more.

	Cat. #	S/Each
Analog Refrigerated	5322-20	8,856.00
Incubated Digital	5322-19	9,019.00



MaxQ 4450 Orbital Shaker
Digital or analog unit combines incubated/refrigerated temperatures.

The small-footprint MaxQ 4450 fulfills a variety of molecular biology, cell culture, and dissolution study.

	Cat. #	S/Each
Analog	5322-02	8,856.00



MaxQ 4000
Analog or digital orbital unit with incubated/refrigerated temperatures

The unit's spacious chamber can handle up to six 2.0 L flasks while the clear lid allows for easy sample viewing.

	Cat. #	S/Each
Analog	5322-04	4,507.00



MaxQ 2000
Analog or digital unit uses triple eccentric drive to ensure smooth, uniform agitation

Operate in continuous or timed mode for applications including cell cultures, bacterial suspensions, solubility studies, staining, and hybridization.

	Cat. #	S/Each
Analog	5322-00	1,488.00



Low Cost Orbital Shakers
Gentle to vigorous agitation unit available in two flask sizes

Features built-in timers and can accommodate either thirteen 125 ml Erlenmeyer flasks or nine 250 ml flasks, depending on the model. Gentle to vigorous agitation at 40 to 220 rpm is adjustable.

	Cat. #	S/Each
(13 flask model)	5322-62	832.00



Dual-Action Orbital and Reciprocating Shakers
Analog operating system is coupled with three-platform optional configuration

This affordable analog, dual-action orbital and reciprocating shaker is ideal for a wide range of laboratory applications.

	Cat. #	S/Each
	5322-68	1,837.00

WATER SYSTEMS: DI AND RO – COMPLETE SPECS AT TERRAUNIVERSAL.COM



Barnstead MicroPure

These ultrapure water systems provide 15 liters per day of Type 1 water for molecular biology, microbiology, and analytical chemistry laboratories.

	Cat. #	S/Each
A. Analytical and UV System	3614-91	3,375.00
B. UV-ST System	3614-96	3,531.00



B-Pure Cartridge System

Provides point-of-use deionization for laboratories and other facilities requiring pure water. Accepts most Thermo Scientific Barnstead cartridges and filters.

	Cat. #	S/Each
C. B-Pure	3613-52	366.00



Diamond RO

These reverse osmosis systems provide flow rates of 12 or 24 liters per hour of Type II water and include prefilter. Many storage units available.

	Cat. #	S/Each
D. Diamond RO, 12 LPH	3614-38	3,527.00
E. 30 L Storage Reservoir	3614-41	756.00



A. CxF Series -40°C and -86°C Chest Freezers by Revco

The CxF Series Chest Freezers are designed to provide versatile and reliable sample storage. An intuitive microprocessor control panel allows personnel to see set points, system status and alarm messages. A variety of sizes and temperature ranges are available to accommodate most application requirements.

B. UxF Series -86°C Upright Freezers by Revco

The UxF Series freezers provide outstanding sample protection, while maintaining the highest standards in performance, energy efficiency and capacity per footprint. A dual-cascade system provides faster recovery after door openings, tighter uniformity, and reduces energy use. A variety of sizes and temperature ranges are available to accommodate most application requirements.

C. Revco Pharmacy Refrigerators by Thermo Scientific

These high-performance pharmacy refrigerators provide stable temperature control over a range of +1°C to +8°C. Easily configured for accurate storage and retrieval of pharmacy products, these units also have full extension stainless steel roll-out drawers, safety glass, double-panel doors and a bright digital temperature display that simplifies operation.

	Type	Cryo Box Cap.*	Exterior Dimensions H" x W" x D"	Temp Range (°C)	Capacity (cu. ft.)	Power**	Cat. #	S/Each
A	CxF Ultra Low	63	28.5 x 29.9 x 43.8	-10° to -40°	3	115V	1536-10	5,319.00
	CxF Ultra Low	252	72 x 33.4 x 40.5	-10° to -40°	12.7	115V	1536-11	6,523.00
	CxF Ultra Low	348	87.6 x 33.8 x 40.5	-10° to -40°	17	115V	1536-12	7,442.00
	CxF Ultra Low	396	96 x 33.4 x 40.5	-10° to -40°	20	115V	1536-13	7,539.00
	CxF Ultra Low	63	28.5 x 29.9 x 43.8	-50° to -86°	3	115V	1536-14	7,799.00
	CxF Ultra Low	252	72 x 33.4 x 40.5	-50° to -86°	12.7	115V	1536-15	9,748.00
	CxF Ultra Low	348	87.6 x 33.8 x 40.5	-50° to -86°	17	115V	1536-16	10,480.00
	CxF Ultra Low	396	96 x 33.4 x 40.5	-50° to -86°	20	115V	1536-17	12,267.00
B	UxF Ultra Low	300	17.78 x 28.29 x 51.23	-50° to -86°	14.9	115V	1536-24	10,715.00
	UxF Ultra Low	400	23.13 x 28.29 x 51.23	-50° to -86°	19.4	115V	1536-25	12,114.00
	UxF Ultra Low	500	28.75 x 28.29 x 51.23	-50° to -86°	19.4	115V	1536-26	13,045.00
	UxF Ultra Low	600	34.38 x 28.29 x 51.23	-50° to -86°	19.4	115V	1536-27	13,977.00
	UxF Ultra Low	700	40.0 x 28.29 x 51.23	-50° to -86°	19.4	115V	1536-28	14,832.00
		No. of Drawers						
C	Pharmacy Refrigerator	5	24 x 29.5 x 73.6	1° to 8°C	11.5	115V	1620-27	3,974.00
	Pharmacy Refrigerator	6	28 x 36.4 x 79.2	1° to 8°C	23.3	115V	1620-31	5,969.00
	Pharmacy Refrigerator	6	34 x 36.4 x 79.2	1° to 8°C	29.2	115V	1620-35	6,860.00
	Pharmacy Refrigerator	12	56.5 x 36.4 x 79.2	1° to 8°C	51.1	115V	1620-39	7,961.00

* Using 2" Box Rack. ** Other voltages available.



BlotBoy™ and Mini-BlotBoy™ Rockers

These platform rockers provide the perfect 3-dimensional motion for all blot-related applications. Their tilt angle and speed are set for optimal gentle but thorough mixing in gel trays, boxes and other flat vessels. Both models include brushless motors and autoclavable flat mats. They are ideal for blot washes and gel staining/destaining and safe for use in cold rooms and incubators. They accept stackable platforms and handle loads up to 2 kg. Both are 110VAC.

	Cat. #	S/Each
BlotBoy™ Rocker	BR02-01	343.00
Mini-BlotBoy™ Rocker	BR02-00	309.00



Biomega Hot Plate/Magnetic Stirrer

This hotplate/stirrer features a durable, chemical resistant 7.5" x 7.5" ceramic work surface and a compact, space-efficient design. Advanced microprocessor controls with convenient turn knobs allow quick, precise adjustment of speed (60 – 1500 rpm) and temperature (to 380°C). Comes complete with support rod for mounting thermometers and temperature probes. Hot plate and stirrer models also available at TerraUniversal.com.

	Cat. #	S/Each
Hot Plate/Stirrer (110VAC)	BR05-00	291.00



MyBlock™ Mini Dry Bath

Benchtop control of sample temperature has never been this easy or economical. The new MyBlock™ Mini fits almost anywhere and can even be used "on-the-go" in cars, boats or wherever a 12 volt power source is available. Its simple touch pad control with digital display is designed for "set and walk away" temperature selection and unrivaled accuracy. At less than 4.4 inches wide, MyBlock™ Mini is truly the first personal block incubator.

	Cat. #	S/Each
MyBlock™ Mini	BR10-00	191.00
12V vehicle power adapter	BR10-07	35.00



Mortexer™ Vortexer

The Mortexer™ offers variable speed vortex mixing up to 3400 rpm and the power of instant vortexing, even for 50 ml sample tubes, with minimum noise and vibration, using touch or continuous operation. The Mortexer™ is cold room and incubator compatible. It comes equipped with a Multi-Head™ with a traditional head for general purpose mixing and holds eight microcentrifuge tubes; other accessories are available—call for details.

115V, 60Hz model below. A 230VAC model is also available.

	Cat. #	S/Each
Mortexer™	BR01-00	209.00



Multi-Therm™ Thermal Mixer

The high-capacity Multi-Therm™ uses a 3 mm vortexing motion to shake and vortex to 1500 rpm. It heats to 100°C with a temperature accuracy of ±1% and is also available in a heat and cool model. The easy-to-read LCD displays both selected and actual speed, time, and temperature settings, continuously. An interchangeable block, sold separately, is required for use; blocks are available in various configurations—call for details.

115V, 60Hz models below. 230VAC models are also available.

	Cat. #	S/Each
Heat	BR14-00	1,633.00
Heat/Cool	BR14-02	2,179.00



Orbi-Shaker and Orbi-Shaker Jr.

The Orbi-Shaker™ (pictured above with MAGIC Clamp Platform) is capable of mixing a 14 lb load capacity up to speeds as high as 300 rpm. The standard platform (included) features a non-slip, rubber coated surface, ideal for tissue culture flasks, Petri dishes and staining trays. The Orbi-Shaker Jr.™ (not pictured) is a space-saving shaker, complete with a 9.5 x 8 in. non-slip, rubber coated platform that is ideal for tissue culture flasks, Petri dishes and staining trays. Additional platforms and accessories are also available, including MAGIC Clamp™ platforms which use magnetic accessories to instantly exchange laboratory vessels.

	Cat. #	S/Each
Orbi-Shaker™ (115V; 230 V avail.)	BR09-12	1,272.00
MAGIC Clamp for Orbi-Shaker	BR09-09	199.00
Orbi-Shaker™ Jr. (universal)	BR09-00	769.00
MAGIC Clamp for Orbi-Shaker Jr.	BR09-01	190.00



**FreeZone® 1 Liter
Benchtop Freeze Dry Systems**

Ideal for light aqueous sample loads, these units have an upright stainless steel collector coil (removes a max. of 1 L of water in 24 hrs.). Features: ¼-HP refrigeration system, LCD display, CFC-free refrigeration system.

115V	Cat. #	S/Each
	6922-00	4,291.00



**FreeZone Plus 2.5 Liter
Freeze Dry Systems**

These units handle light sample loads and the upright stainless steel collector coil removes 1.8 L of water/24 hrs., and holds 2.5 L of ice before defrosting.

Cat. #	S/Each
3647-80	8,676.00



**FreeZone Plus 12 Liter Cascade
Console**

Designed for light to moderate sample loads with low eutectic points, units remove 6 liters of water in 24 hours and cool collector reaches to -84°.

Cat. #	S/Each
6922-20	13,525.00

Also available in 4.5 and 6 liter capacities



CentriVap® micro IR Vacuum Concentrators

Compact and portable, this concentrator is ideal for DNA samples and small throughput environments. The micro infrared (IR) strobe light speeds evaporation, reduces cross contamination, and allows user to view samples through the glass lid while the rotor is spinning. The magnetic induction drive achieves speeds up to 1700 rpm. Rotor (included) holds 24 small samples; select sample tubes separately at Laboratory-Equipment.com.

Cat. #	S/Each
3648-25	5,491.00



RapidVap® Vacuum Evaporation System

An alternative to traditional centrifugal evaporation systems, the RapidVap is ideal for preparation of samples in a variety of applications in drug discovery, agrichemistry, mycology testing, and environmental analysis. It uses microprocessor-controlled vacuum, heat, and vortex motion to speed evaporation rates, even with aggressive chemicals. Processes up to 110 samples up to 450 ml at a time. Model below features vortex motion; other available with lid heater and RS-232 link, and accessories include aluminum blocks. Details at Laboratory-Equipment.com.

Cat. #	S/Each
6922-60	9,747.00



Practum® Analytical Balances

A great value for standard applications in busy labs. **Features:** rugged weigh cell for reliable results; sturdy draft shield, extra-large feet and up-front level indicator. Dimensions: 8.5"W x 14.1"D x

Weighing Capacity	Cat. #	\$/Each
120 g	5701-18	1,559.00
220 g	5701-17	1,856.00



Quintix® Analytical Balances

Designed for daily lab routine, balances include built-in applications for custom settings. **Features:** isoCAL for accurate results, touchscreen, user interface and data transfer. Dimensions: 8.5"W x 14.1"D x 12.6"H.

Weighing Capacity	Cat. #	\$/Each
120 g	5702-01	2,430.00
220 g	5702-02	2,754.00



Secura® Analytical Balances

Units with integrated systems and safety features are ideal in pharmaceutical applications. **Features:** level control, password protection, USP min. sample weight measurement and isoCAL. Dimensions: 8.5"W x 14.1"D x 12.6"H.

Weighing Capacity	Cat. #	\$/Each
120 g	5702-03	3,159.00
220 g	5702-04	3,571.00



Cubis® Ultra-Micro Balance

Modular and configurable models are designed for filter weighing, customized work flows and high resolutions. For stringent compliance requirements: **Specs:** dimensions: 9.4"W x 14"D x 3.5"H; semi-automatic leveling; readability: 0.0001 mg.

Weighing Capacity	Cat. #	\$/Each
2.1 g	5701-00	29,437.00



Cubis Micro-Balance

Modular and configurable models are designed for the smallest sample weighing, customized work flows and high resolutions. For stringent compliance requirements: **Specs:** dimensions: 9.4"W x 14"D x 3.5"H; semi-automatic leveling; readability: 0.0005 mg (max).

Weighing Capacity	Cat. #	\$/Each
	5701-02	18,144.00



Cubis Semi Micro-Balance

Modular and configurable models are designed for filter weighing, customized work flows and high resolutions. For stringent compliance requirements: **Specs:** dimensions: 9.8"W x 17.7"D x 14"H; Integrated Ionizer; automatic Leveling; readability: 0.01 mg.

Weighing Capacity	Cat. #	\$/Each
	5701-04	13,163.00



Entris® Analytical Balance

Models have built-in applications and function keys for easy operation. Backlit display provides easy viewing of controls. **Specs:** dimension: 9.1"W x 11.9"D x 13"H; weighing pan: 3.5" diam; weighing capacity: 60 g to 220 g.

Weighing Capacity	Cat. #	\$/Each
60g	5702-84	13,163.00



Entris Precision Balance

User-friendly models have built-in applications and function keys for easy operation. Backlit display provides easy viewing of controls. **Specs:** 11.9"W x 9.1"D x 5.4"H; weighing pan: 4.5" diam; weighing capacity: 150 g to 620 g.

Weighing Capacity	Cat. #	\$/Each
150g	5702-86	644.00



Entris Top-Loading Precision Balance

Models have built-in applications and function keys for easy operation. Backlit display provides easy viewing of controls. **Specs:** dimension: 11.9"W x 9.1"D x 5.4"H; weighing pan: 7.1" X 7.1"; weighing capacity: 820 g to 8200 g.

Weighing Capacity	Cat. #	\$/Each
8200 g	5702-98	787.00



Biowave DNA UV/Vis Spectrophotometer

Specifically designed for life science applications, this powerful tool determines nucleic acid purity and concentration, protein concentrations or cell density measurements. It uses Gifford Optics for high energy throughout, a Xenon light source for long lamp life and a large graphical display for ease of use and data interpretation. Compatible with low-volume cuvettes.

	Cat. #	\$/Each
Biowave DNA	5300-15	4,824.00
Biowave DNA with printer	5300-16	5,348.00



S800/S1200 Spectrawave Visible Diode Array Spectrophotometers

These compact, lightweight, easy-to-use instruments measure absorbance, % transmission, absorbance ratio and concentration. The large backlit graphical display of the S1200 enables viewing of wavelength scans, kinetic assays (including slope calculation) and standard curves. Both models accept standard 10 mm pathlength glass or plastic cuvettes; an adapter is available for 10, 12, and 16 mm test tubes.

	Cat. #	\$/Each
S800 UV/Vis	5300-09	1,977.00
S1200 UV/Vis	5300-10	2,418.00



LAMBDA™ Bio+ Spectrophotometer by Perkin Elmer

Designed for life-science laboratories, these compact units offer a full suite of stored methods including DNA, RNA and Oligonucleotide calculations, protein assays such as direct UV measurement, BCA, Biuret, Bradford and Lowry. These spectrophotometers measure absorbance or concentration at any wavelength. Results may be printed to an integrated high-quality printer or stored and printed via SD flash memory card.

	Cat. #	\$/Each
LAMBDA Bio+ with printer	5102-02	5,997.00
LAMBDA Bio+ with SD Card	5102-03	5,902.00



LAMBDA XLS+ Spectrophotometer by Perkin Elmer

The LAMBDA XLS+ is designed for academic and industrial laboratories that require dedicated instrument with a small footprint and extreme reliability and sensitivity. It includes an easy-to-read display and comprehensive suite of built-in application software; measurement modes include single- and multi-wavelength modes, scanning kinetics, and concentration, with the ability to store up to 90 methods for easy access.

	Cat. #	\$/Each
LAMBDA XLS+ with printer	5102-00	5,712.00
LAMBDA XLS+ with SD card	5102-01	5,617.00



MaxQ™ 5000 Incubated & Refrigerated Floor Shakers

Foot pedal models for hands-free use

Incubated and refrigerated floor shakers have an easy-access drain, unbalanced load sensor and casters.

- Dimensions: 41"W x 32"D x 41"H
- Orbit Diameter: 1"; Maximum Load: 75 lbs.
- Temp. Analog: 10°C above ambient to 50°C
- Temp Digital: 15°C above ambient to 50°C

Floor Model, 120V	Cat. #	S/Each
Incubated-Digital	5322-19	9,019.00
Refrigerated-Analog	5322-20	8,856.00
Incubated-Refrigerated	5322-21	10,255.00



MaxQ 4450 Incubated Orbital Shaker Chamber holds up to four 1 L flasks.

These compact, orbital shakers have an optional chiller to achieve temperature ranges from 20°C to 30°C.

- Dimensions: 14.1"W x 27.2"D x 15.8"H
- Orbit Diameter: 0.75"
- Maximum Load: 35 lbs.
- Operating Temperature: 5°C above ambient to 80°C

Incubated, 120V	Cat. #	S/Each
Analog	5322-02	3,621.00
Digital	5322-03	3,590.00
Analog w/Cooling Coil	5322-09	3,275.00
Digital w/Cooling Coil	5322-10	3,754.00



MaxQ 4000 Incubated and Refrigerated Orbital Shakers Chamber holds up to six 2 L flasks

Units have three temperature ranges to fulfill various application needs.

- Dimensions: 22.5"W x 32"D x 22"H
- Orbit Diameter: 0.75"
- Maximum Load: 50 lbs.
- Operating temp: 10°C above amb. to 50°C

Model, 120V	Cat. #	S/Each
Incubated-Analog	5322-04	4,507.00
Incubated-Digital	5322-05	5,565.00
Refrigerated-Analog	5322-06	5,906.00
Refrigerated-Digital	5322-07	6,382.00



MaxQ 2000 Open-Air Platform Shakers Accommodates 3 platform sizes

Compact units can be used in refrigerators, incubators and warm rooms.

- Dimensions: 18.5"W x 17.4"D x 5.5"H
- Orbit Diameter: 0.75 in./Maximum Load: 35 lbs.
- Operating Temperature: 0 to 40°C, 20 to 80% RH, non-condensing

120 V Models	Cat. #	S/Each
Analog	5322-00	1,488.00
Digital	5322-01	1,721.00



Compact Digital Mini Rotator Accommodates 50 ml to 2 L flasks

Compact models with smooth and quiet horizontal mixing can fit inside CO₂ incubators and refrigerators.

- Dimensions: 10.9"W x 13"D x 5.1"H
- Platform Dimensions: 9.8"W x 9.8"D
- Orbit Diameter: 0.51"
- Maximum Load: 8.81 lbs.

Model 120 V	Cat. #	S/Each
50 – 300 rpm	5322-62	832.00



Compact Digital Microplate Shaker Shakes four microplates in one run

For precise and accurate shaking of microplates, units can be placed inside incubators (non-CO₂) and refrigerators.

- Dimensions: 9.8"W x 5"D x 13"H
- Orbit Diameter: 0.12"/Maximum load: 8.8 lbs.
- Operating Temp: 0° to 40°C and humidity conditions from 20 to 80% non-condensing

Speed Range	Cat. #	S/Each
40 – 1100 rpm	5322-90	693.00



**myBath™ Digital Water Bath
by Benchmark Scientific**

These compact models are made with high-efficiency insulation, and they maintain temperature stability and uniformity for heating reagents and samples.

- Temperature Range: Ambient +5 to 100°C
- 4 L model includes racks for 1.5/2.0, 15 & 50 ml tubes
- 8 L and 12 L models include drains
- 4 L, 8 L, and 12 L units have removable gable
- Digital controls to select and monitor water temperature
- 3-digit display shows temperature increments
- Quik-CAL™ temperature calibration function (2 L models use traditional calibration)
- Seamless, rust-resistant stainless-steel chamber with rounded corners for easy cleaning

myBath Digital Water Bath Series, 115V

Liter	Interior Dimensions W" x D" x H"	Cat. #	S/Each
2 L	5.5 x 6 x 4	BR17-02	458.00
4 L	5.3 x 9.4 x 5.5	BR17-00	723.00
8 L	12.8 x 10.4 x 5.9	BR17-03	705.00
12 L	12.8 x 10.4 x 7.9	BR17-04	836.00



**Refrigerated/Heating Circulator
by JULABO**

Working temperature: -20°C to 100°C

Models are used for external instrument integration and for temperature applications directly in the bath.

- Circulating pump provides short heat-up and cool-down times
- LED temperature display, resolution 0.1°C
- Keypad switches automatically to the actual value; PID1 temperature control
- Adjustable high temperature cut-out / dry-running protection
- Includes 2 barbed fittings and removable venting grill

Temperature Range	Cat. #	S/Each
-20 to 100°C	2540-00	2,928.00



Cryo-Compact Circulators BY JULABO

Working temperature: -40°C to +200°C

Compact models are designed to be stored side-by-side with other units or directly under a fume hood.

- Dimensions: 9.5"W x 18.1"D x 15.8"H
- Ventilation air cooling
- Maximum ambient temperature of +40°C
- Heating capacity of 2 kW
- Filling volume: 3.5 L
- Wetted parts made of stainless steel or plastic

Temperature Range	Cat. #	S/Each
-30 to 150°C	2540-04	5,022.00



Recirculating Coolers by JULABO

Working temperature: -25°C to +130°C

Cost-efficient, energy-saving models are suited for any cooling requirement in labs or industrial environments.

- Cooling capacity up to 20 kW!
- Splash-proof keypad; LED display
- Alarm output and RS232 (select models)
- Filling-level indicator and pressure indicator
- Circulating pumps; Optional air or water cooling
- Easy fill and drain tap readily accessible
- All wetted parts made of stainless steel or high grade plastic(except FC-T models)

Temperature Range	Cat. #	S/Each
-20 to 40°C	2540-13	5,201.00



Disposable Gloves

We offer a wide variety of cleanroom gloves suitable for different applications and cleanliness requirements. The Nitrile cleanroom gloves are available in sterile packaging for use in ISO 4 environments and in non-sterile packaging appropriate for ISO 4 – 7. A PVC cleanroom glove is also available which has excellent ESD properties and is a good fit for use in microelectronics manufacturing.

Sterile Nitrile Cleanroom Glove, ISO 4 (200 Pairs)		
Size	Cat. #	\$/Case
SM	5605-30	244.00
MED	5605-31	244.00
L	5605-32	244.00
XL	5605-33	244.00
XXL	5605-34	244.00

Nitrile Cleanroom Glove, ISO 6 (1,000 Pieces)		
Size	Cat. #	\$/Case
SM	5605-43	136.00
MED	5605-44	136.00
L	5605-45	136.00
XL	5605-46	136.00

Nitrile Cleanroom Glove, ISO 4 (1,000 Pieces)		
Size	Cat. #	\$/Case
SM	5605-35	209.00
MED	5605-36	209.00
L	5605-37	209.00
XL	5605-38	209.00

Powder-free Nitrile Glove, ISO 7 (1,000 Pieces)		
Size	Cat. #	\$/Case
SM	5605-47	136.00
MED	5605-48	136.00
L	5605-49	136.00
XL	5605-50	136.00

Nitrile Cleanroom Glove, ISO 5 (1,000 Pieces)		
Size	Cat. #	\$/Case
SM	5605-39	140.00
MED	5605-40	140.00
L	5605-41	140.00
XL	5605-42	140.00

PVC Glove, ISO 7 (1,000 Pieces)		
Size	Cat. #	\$/Case
SM	5605-51	126.00
MED	5605-52	126.00
L	5605-53	126.00
XL	5605-54	126.00



Gloves Liners

These lightweight, non-linting liners are knitted with fine-gauge, 100% virgin nylon. They provide dexterity in finger tips, while offering comfort and improved grip in palm. Quality, sturdy construction allows liners to be laundered and reused. Universal size and ambidextrous shape fits comfortably under latex, PVC or nitrile gloves. Suitable for use in controlled environments.

Style	Number of gloves per bag	Cat. #	\$/Bag
Full-finger	12 pairs	5605-29	20.00
Half-finger	12 pairs	5605-28	17.00



Wipers

Terra Universal offers an assortment of cleanroom and laboratory wipers to suit every need.

Cotton Wipers are woven for strength and durability, while also clean and absorbent. Ideal for cleaning magnetic disk media surfaces, high heat applications, and absorbing aqueous and organic solvent spills. Suitable for ISO 6 and higher cleanrooms.

Size	Qty./Bag	Cat#	\$/Each
9" x 9"	75	5605-07	71.00

Laundered Polyester Wipers are ideal for critical environments where ultra-low particle/fiber generation and absorbent capacity is important. Soft yet durable construction cleans surfaces without scratching. The 2-ply wiper is commonly used in pharmaceutical applications as a primary process wiper.

Size	ISO 14644	Qty./Bag	Cat#	\$/Bag
9" x 9"	ISO 3	150	5605-00	30.00
9" x 9"	ISO 4	150	5605-11	33.00
4" x 4"	ISO 5	600	5605-15	55.00
9" x 9"	ISO 5	150	5605-01	32.00
12" x 12"	ISO 5	100	5605-10	25.00

Nonwoven Pre-saturated Wipers saturated with semiconductor grade (filtered to 0.2 micron) 70% isopropyl alcohol and 30% de-ionized 18 mega ohm water. Processed and packaged in a controlled environment. Ideal wiper for electronics applications and for general use in pharmaceutical and semiconductor industries. Designed for ISO 6 applications and above.

Size	Quantity	Cat#	\$/Pail
9" x 9"	75/Pail	5605-55	29.00



Cleanroom Paper

Specially formulated cleanroom paper minimizes particle generation in controlled environments. Ultra-low particle, extractable and metallic ion content. High tear and tensile strength, burst strength of 50 lbs. per inch. Compatible with virtually any ink or copier system. Processed and double bagged in a ISO 5 cleanroom.

Color	Weight	Size	Reams*/Case	Cat. #	\$/Case
White	23#	8.5" x 11"	10	5605-18	142.00
Blue	23#	8.5" x 11"	10	5605-21	142.00

* 250 sheets per ream.

Visit TerraUniversal.com for contamination and performance characteristics



Thousands of Products in Stock

Laboratory-Equipment.com and TerraUniversal.com offer popular cleanroom and laboratory equipment from trusted manufacturers.

Prices in BLUE represent in-stock items and products available for quick shipping.

Need it Soon? Built-to-order products are available for Fast Track 24/7. Contact Terra Universal at 714-578-6100.



Online Selection and Configuration Tools **Select & Configure**

Product Selector makes it easy for you find the exact product you need.

System Builder easily lets you configure your system with options and accessories



Order Online

Easy online ordering on thousands of ready-made products and pre-configured systems.

Online quote requests for made-to-order and custom products.



Low-Cost Domestic and International Shipping

Competitive quotes include customs brokerage and duties for door-to-door delivery



Hassle-Free Pricing

Web prices honored worldwide



Diverse, Compliant and Cost-Effective



Laboratory-Equipment.com offers a diverse range of laboratory products at competitive prices. Select products meet USP-797, ISO Class 5 – 8, CE, CA/CAN, TUV and many other compliance standards.

Visit www.Laboratory-Equipment.com to view thousands of products from trusted manufacturers.



Global Network of Sales Representatives

Complete listing at TerraUniversal.com



Free-Shipping

On all products at Laboratory-Equipment.com shipped to the continental U.S.



All prices and specifications are subject to change without notice. Crating charges apply to selected items. Call for information.