

ValuLine® Hardwall Modular Cleanroom

© Copyright 2026 Terra Universal Inc. All rights reserved. - Revised Feb. 2026



Your Comprehensive
Equipment Source





Table of Contents

Section 1.0 – Description

Safety Notice.....	3
Fan Filter Units.....	5
Light Panels	5
Blank Ceiling Panels	5
Side Panels.....	5
Power Supply Unit (PSU).....	5

Section 2.0 – Installation

Site Preparation	6
Required Installation Equipment	6
Standard Component List	7
Reference Videos	7
Hardware Reference Table	8
Cleanroom Frame Components Reference	10
Ceiling Components Reference	10
Support Bar Components Reference	11
Wall Panel Components Reference	11
Frame Assembly	12
Joist and Divider Installation	15
Use of the Spacer	18
Support Bar Installation	19
Installing the Ceiling Modules and Panels.....	20
Installing the Wall Panels	20
Fire Sprinkler System Installation.....	25
Fire Sprinkler System.....	25

Section 3.0 – Electrical Wiring

Installing the Power Supply Unit (PSU).....	26
Light Panel Hard Wiring	28

Section 4.0 – Service & Maintenance

Cleaning and Sterilization	29
Wipes.....	29
Vacuums	29
Mini-Environment Cleaning Kits	30
Replacing Light Fixtures.....	30
Filter Replacement.....	30
Removing the Fan/Filter Unit	30



Section 5.0 – Specifications

Component Specifications 32

Section 6.0 – Parts & Accessories

Spare Parts & Accessories 34

Section 7.0 – Warranty

Warranty Information 34



Proprietary Notice

This manual pertains to proprietary devices manufactured by Terra Universal, Inc. Neither this document nor any portion of it may be reproduced in any way without prior written permission from Terra Universal.

Terra Universal makes no warranties applying to information contained in this manual or its suitability for any implied or inferred purpose. Terra Universal shall not be held liable for any errors this manual contains or for any damages that result from its use.

Safety Notice

A thorough familiarity with all operating guidelines is essential to safe operation of the product. Failure to observe safety precautions could result in poor performance, damage to the system or other property, or serious bodily injury or death.



CAUTION

Cautions are used when failure to observe instructions could result in significant damage to equipment.

The following symbols are intended to call your attention to two levels of hazard involved in operation:



WARNING

Warnings are used when failure to observe instructions or precautions could result in injury or death.

The information presented here is subject to change without notice.



IMPORTANT SAFETY NOTICE

Terra Universal cleanrooms are not designed to support more weight than the blower modules and lighting fixtures originally installed. Ceiling grid beams are not load-bearing and will not support personnel or other additional loads. Placing added weight on the ceiling grid may result in serious damage to the cleanroom and its occupants.

Safety notices supplied by Terra Universal must be affixed prominently on each side of the cleanroom grid.

1.0 Description

Designed to combine economy and versatility, this system features ceiling HEPA Fan Filter Units that direct a continuous flow of HEPA or ULPA-filtered air through the enclosure. The continuous positive pressure created by this laminar air-flow helps to control particles generated inside the enclosure by forcing them out the air vents. This design also helps to prevent contaminants from entering the cleanroom when an access door is opened.

The Modular Hardwall Cleanroom is supported by a rigid frame structure consisting of powder-coated 2" - square steel upright members and horizontal cross members. Joists supported by the frame form 2' x 4' ceiling grids that accommodate the interchangeable ceiling modules. All of these ceiling modules rest against the ceiling grid frame to form a tight seal along the perimeters.





Fan Filter Units

Fan Filter Units (FFUs) direct a vertical laminar flow of filtered air downward through the enclosed cleanroom area.

Each FFU includes a 700 CFM impeller blower (average flow at 100 FPM with filter load) mounted in a powder-coated steel housing with a plenum design that optimizes uniform air velocity across the entire face of the filter. A HEPA (high efficiency particulate air) filter installed inside the housing is rated 99.99% efficient at 0.3um particles. The filtration medium consists of microporous polyurethane mini-pleats held in place by strong, rigid plastic separators that keep the medium from nesting. The filter is sealed into the sturdy aluminum frame with a fire-retardant, non-outgassing adhesive. On an optional basis, an ULPA (ultra-low penetration air) filter, rated 99.9995% efficient at 0.12um particles, may be substituted for the HEPA filter. Power to the Fan Filter Units is controlled by a ON/OFF switch of the power supply unit.

All 120VAC units and 220VAC, 60Hz units are UL listed. CE-marked models are available for 220VAC, 50Hz operations.

Light Panels

Light Panels are mounted on the ceiling grid to ensure effective illumination of the work area without interfering with the controlled air stream. Each light panel is controlled by the power supply unit.

Power Requirements

USA: 115VAC/60Hz, 1.50A Each
International: 277VAC/50Hz, 0.65A Each

Blank Ceiling Panels

All remaining ceiling grids are covered with blank panels, which can be removed to allow installation of additional fan filter units or light panels. Panels are made of white polypropylene, clear acrylic, clear static-dissipative PVC, vinyl-coated gypsum or steel depending on customer selection

Side Panels

Rigid side panels of the Modular Cleanroom are made of light-weight, transparent polymer (typically acrylic, static-dissipative PVC, or polycarbonate). The walls are attached to the support frame with mirror finish stainless steel brackets and fasteners.

Power Supply Unit

A power supply unit includes ON/OFF switches for lights and FFUs.

Entrance Options

1. **Access Door:** An access door, made of rigid static-dissipative PVC or acrylic mounted in an aluminum frame, affords entrance to the enclosure. The door is 36"W x 80"H and includes inside and outside handles and a pneumatic self-closing damper.



This room is not sealed airtight. Because it is designed to operate under positive pressure, small gaps around the doors or in the panel structure will not compromise clean conditions.



2.0 Installation

Component Inspection: Unpack all system components and check for damaged or missing parts (refer to component list/chart on the next page as well as the sales order to determine correct quantity of parts). Any damage should be reported to the shipping company immediately. Contact Terra Universal if any parts are missing.

Site Preparation

Refer to Terra installation contract for details of work to be performed by Terra Universal technicians or certified installer.

- A. Facility area where the cleanroom is to be installed must provide a minimum clearance of one foot (including fixtures, ducts and pipes) on all sides and at least two feet of vertical clearance between the FFU inlet and ceiling.
- B. Customers must provide permanent electrical connection from supply panel to PSU (at least 20A power line per PSU) in conformance with local electrical code, as well as any vacuum, air, H₂O, sprinkler, or nitrogen connections required for the cleanroom.
- C. If Terra is performing the installation, customers must give advance notice of dates and times for Terra personnel to perform the installation. Short notice may result in higher fees for travel and accommodations.
- D. Customers are to provide utilities, installation power and removal of any packing material.
- E. Because installation requires unpacking and assembling components, customers are to ensure an adequate staging area for parts and equipment adjacent to the assembly area, clear and ready for work.
- F. Customers are to inform Terra Universal in advance of any requirements for security, escorts, special training, badges, work hours, parking areas or special identification and how to obtain all such required permissions and related items.
- G. Prior to shipping, a copy of the cleanroom drawings is placed in the main crate. Refer to the attached drawings for detailed information on how your cleanroom is numbered.
- H. Before you start assembly, it is mandatory that the floor is level to assure the completed room will fit properly and be rectangular. Failure to level the floor may result in the inability to complete the assembly of the room or the insertion of the blowers, lights or ceiling. For vertical alignment measure with the leveler before assembly.

Note: Optional bolts or L brackets can be used to anchor the cleanroom frame to the floor in accordance with local seismic code.

Required Installation Equipment

- A. Handling cleanroom shipping crates, which generally measure over 300 inches long and weigh well over 1,000 pounds, requires at least one forklift or pallet jack. If crates must be moved through narrow aisles or entrances, two forklifts or pallet jacks are recommended, one to support each end.
- B. Unloading crates from the truck is much easier if you have a truck-high loading dock. Without such a dock, you will need at least one forklift and a support to brace one end while the forklift is positioned beneath the center of each crate. Several people are required to unload individual components from the crates.



- Heavy rubber mallets and measuring tapes
- Portable drills/screwdrivers with shaft extensions, ¼-20 nut drivers, 3/8 step drill bits, 3/8 countersink bits, punches, 6-32 and 12-24 taps, 7/16 Wrenches
- Six to ten 11" locking C-Clamps
- Ladders or work platforms

Standard Component List

List and quantities may vary, depending on the order:

- Upright Frame Supports
- Ceiling grid joists and dividers
- Power Supply Unit and wiring
- Power Strip
- Fan/filter units and 4-pin adapter cables to NEMA 5-15
- Light fixtures and adapter cables to NEMA 5-15
- Polymer Side Panels (acrylic, static-dissipative PVC or polycarbonate)
- Mirror-finish stainless steel trimming (for side panels)
- Access door(s)
- Hardware (screws, bolts, clips etc)

Terra Universal Cleanroom Install Videos



Door Assembly Video

https://youtu.be/-Lu8y6CN2_Y





Cleanroom Installation Video

<https://youtu.be/KqQaWWDgmTA>



Hardware Reference Table	
Part	Used For
 #12 – 3/4” Stainless Steel Self-Tapping Hex Head Screw	Ceiling Joists Side Panel Trimming Wall Panel Mounting Brackets
 Christmas Tree Clip	Frame Assembly
 1/4”-20 x 1” Phillip Flat Head Screw	Swing Door Hinge Swing Door Closer Housing

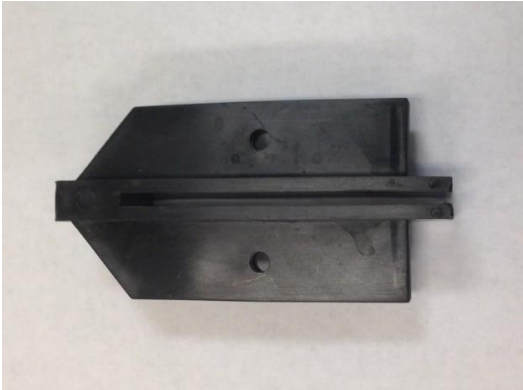

 <p>#10-32 x 3/8" Phillip Pan Head Screw</p>	<p>Swing Door Closer Housing</p>
 <p>Joist Divider Clip</p>	<p>Ceiling Joists and Dividers</p>
 <p>#6-32 x 1/2" Phillip Pan Head Screw</p>	<p>Swing Door Frame Stopper</p>



Cleanroom Frame Components

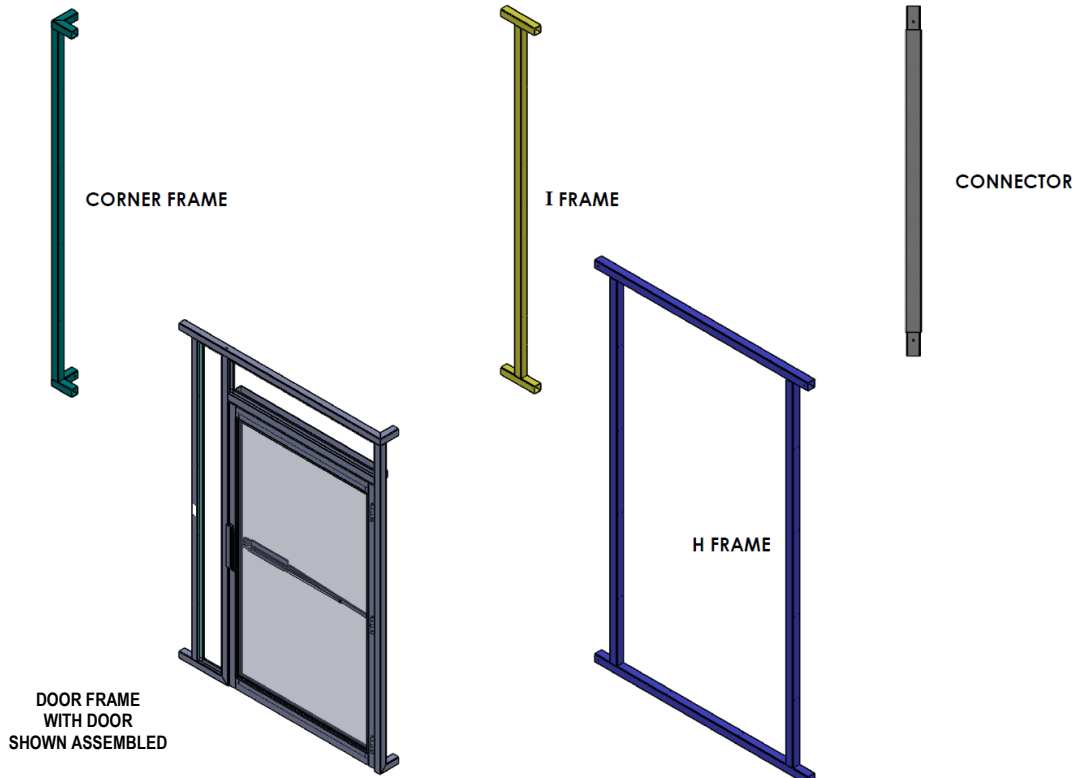

Ceiling Components

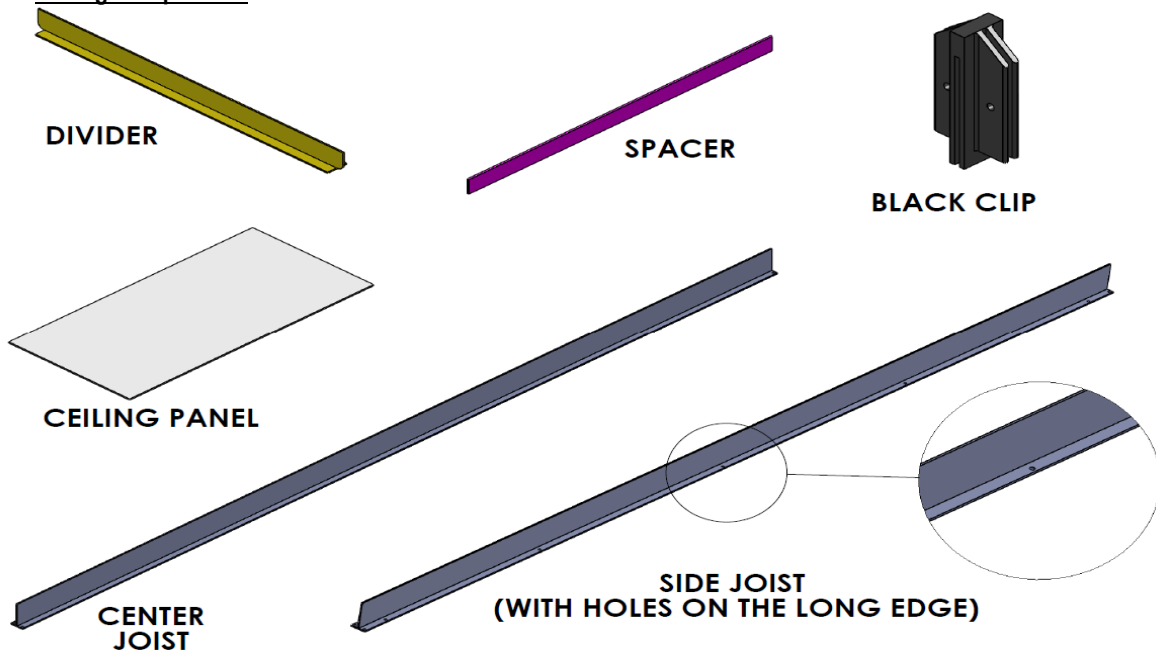



Support Bar Components

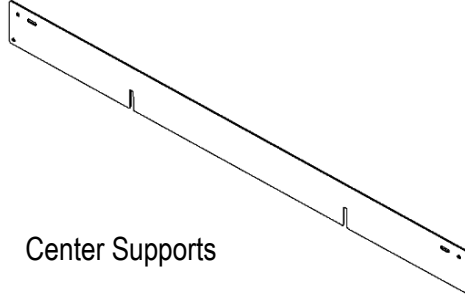

Center Supports

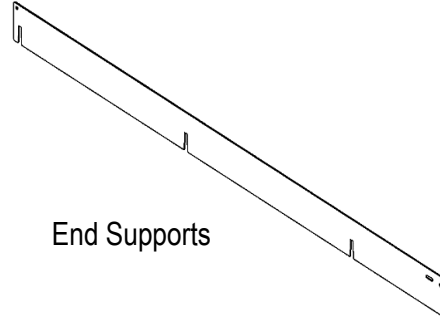

End Supports

Top Trimming Components

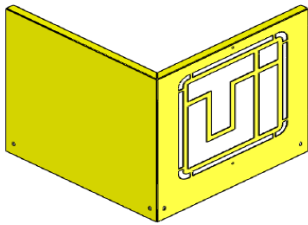

CORNER TRIMMING

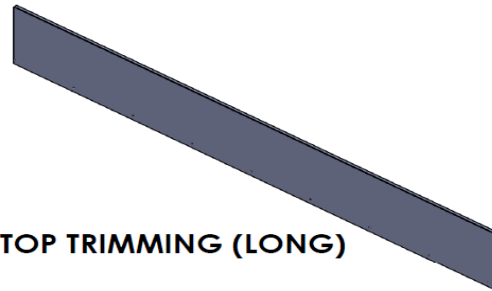

TOP TRIMMING (LONG)

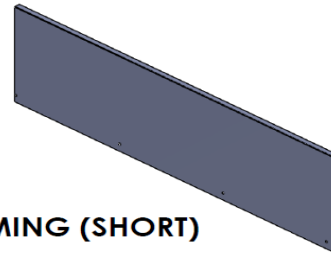

TOP TRIMMING (SHORT)



Wall Panel Components

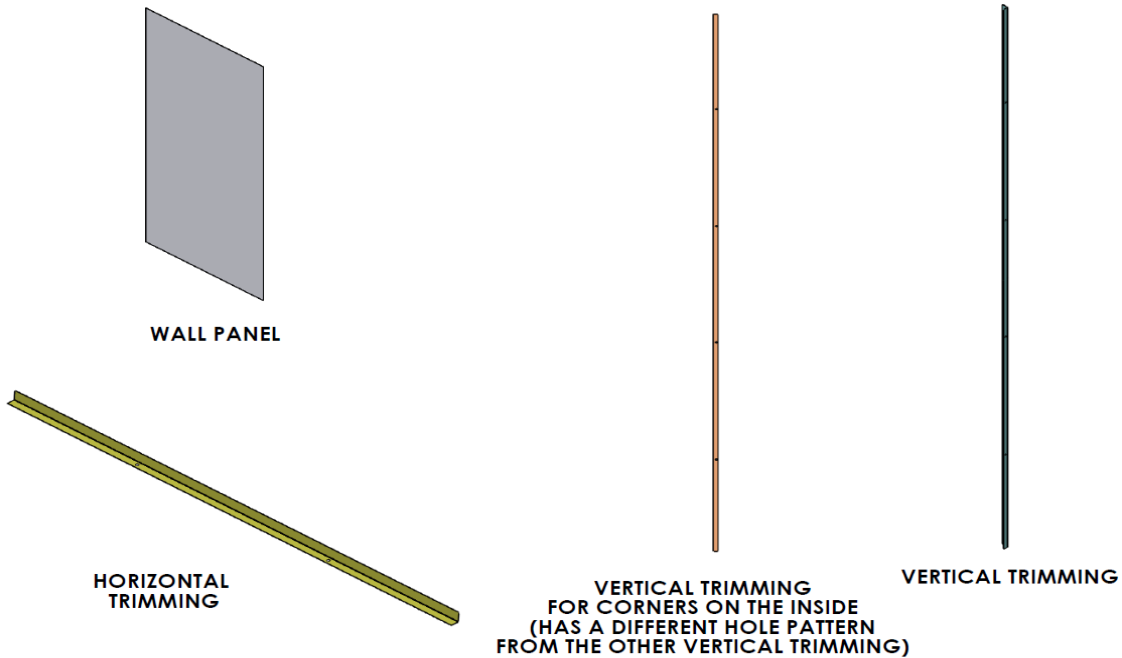

CAUTION

The predrilled holes on the interior corners of the corner frame are offset to prevent fasteners from colliding. Make sure to match up the interior trim before installing.

Frame Assembly

Be sure to familiarize yourself with the placement of the frame members and joists before beginning the assembly (see drawings). Beginning as described in the drawings (typically the door frame, Shown assembled here), assemble the horizontal frame members according to their labels

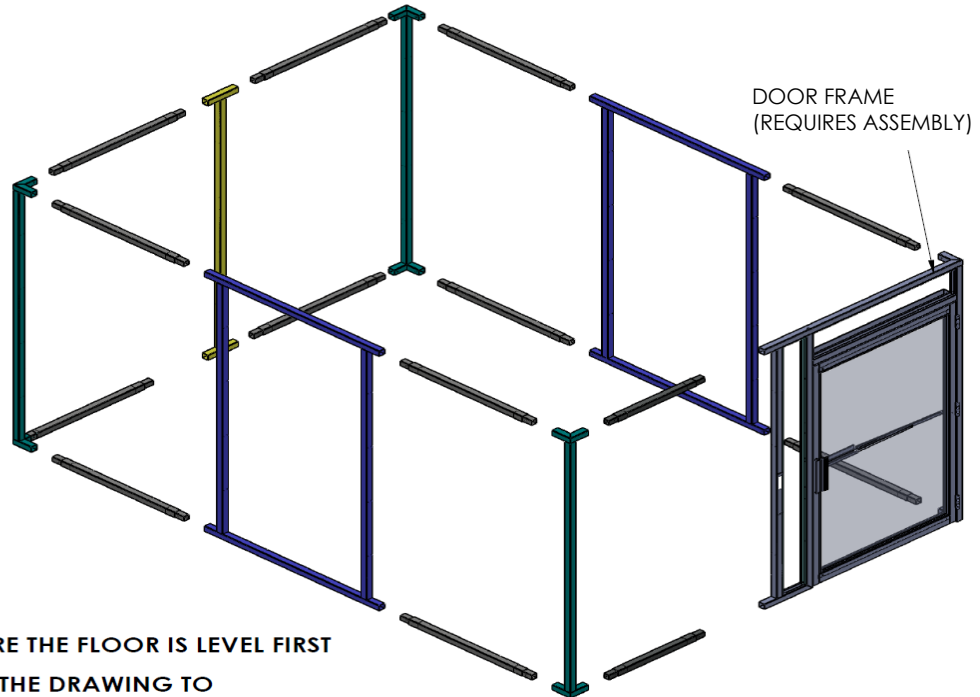

STEP 1: MAKE SURE THE FLOOR IS LEVEL FIRST

STEP 2: REFER TO THE DRAWING TO SEE HOW EACH COMPONENT COMES TOGETHER STARTING WITH THE DOOR FRAME



Door Assembly Video

https://youtu.be/-Lu8y6CN2_Y

After the frame has been completely assembled, square the structure by measuring the length of A and B. If they are not equal, adjust the frame by having someone hold one of the corners down and another person move the opposite corner either in or out until length A and B are equal. Check to make sure that the overall dimensions match the drawing.

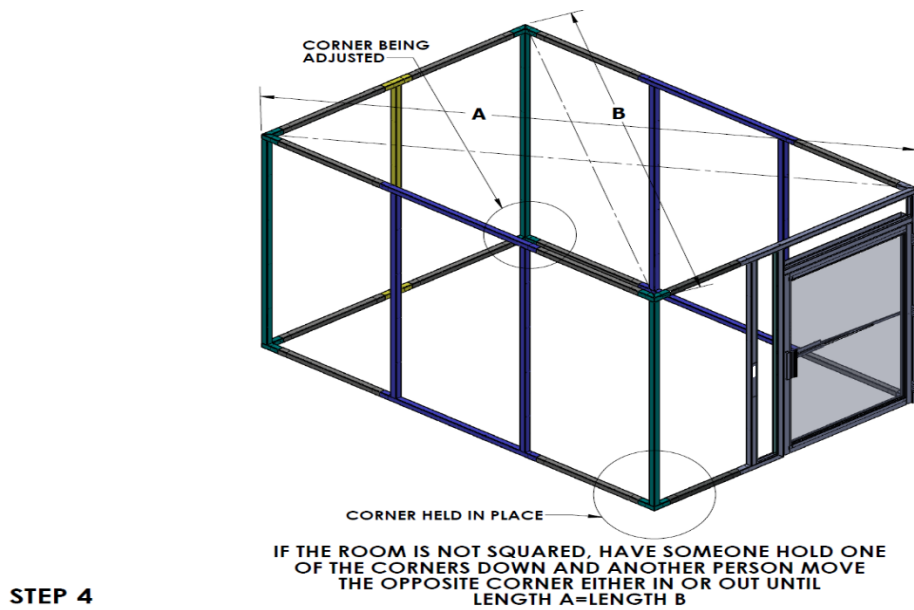
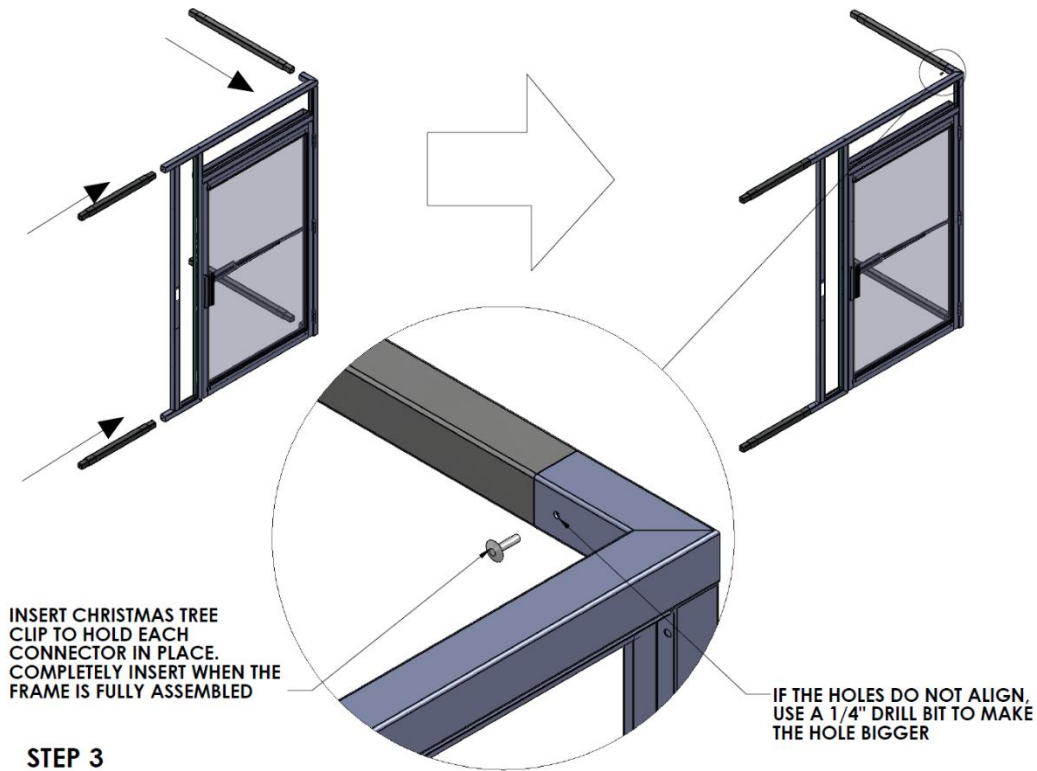



Joist and Divider Installation

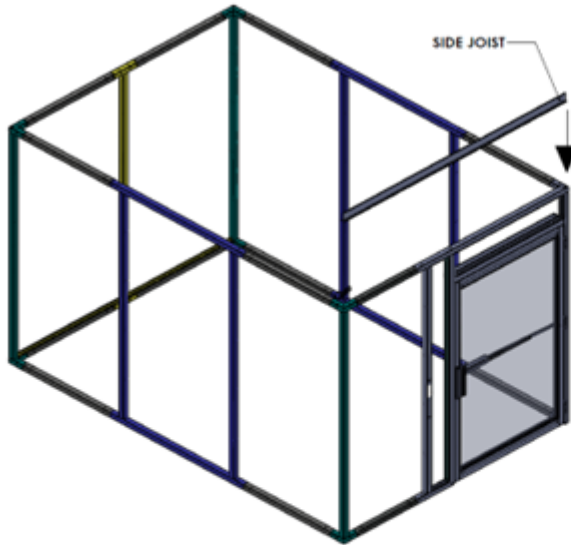

JOISTS ARE BOWED TO COMPENSATE FOR THE WEIGHT OF ALL THE FFUS, LIGHTS, PDMS, AND OTHER CEILING ACCESSORIES

NOTE: ONLY SIDE JOISTS HAVE EXTRA FASTENING HOLES

STEP 1

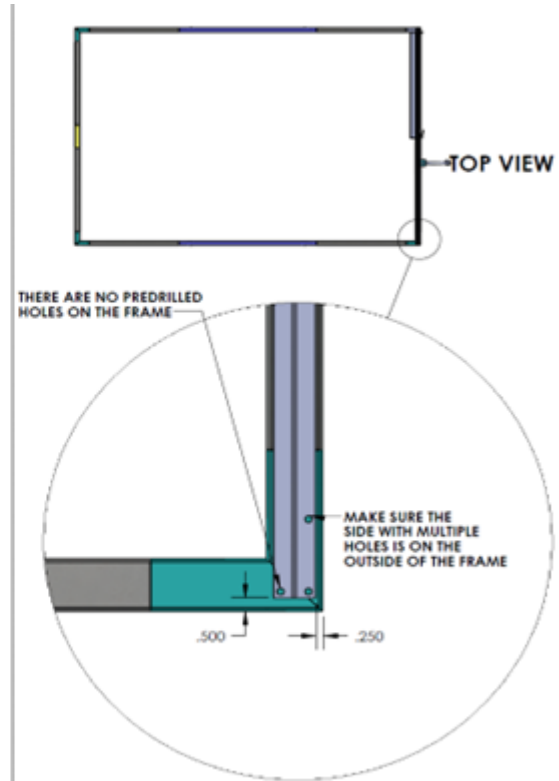

STEP 2

Make sure to fasten the side joist along the entire length of the cleanroom.

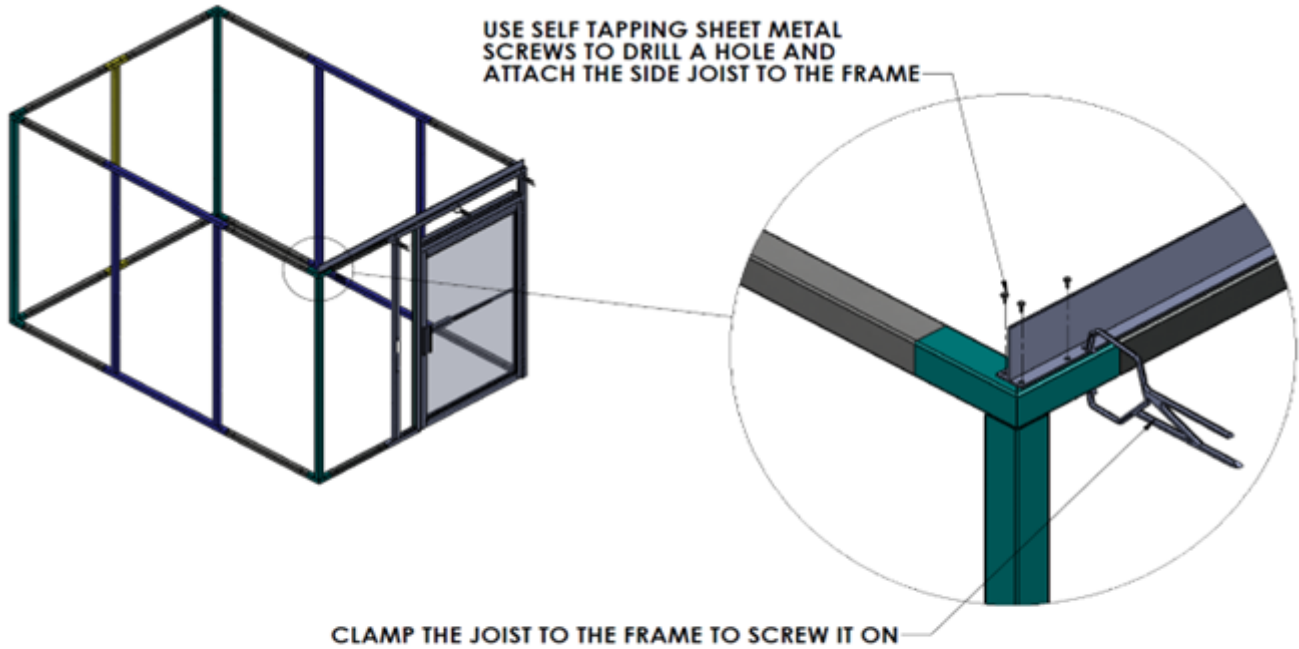

REMOVE THE CLAMPS AFTER SCREWING THE JOIST TO THE FRAME

STEP 3

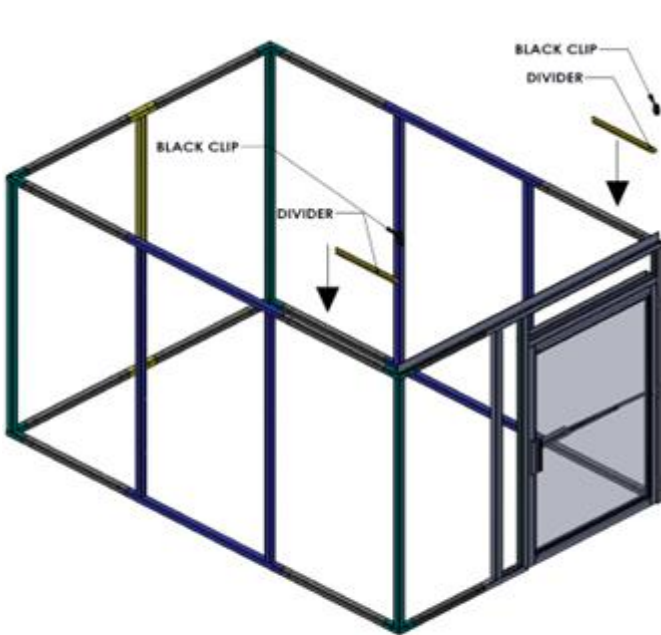

STEP 4

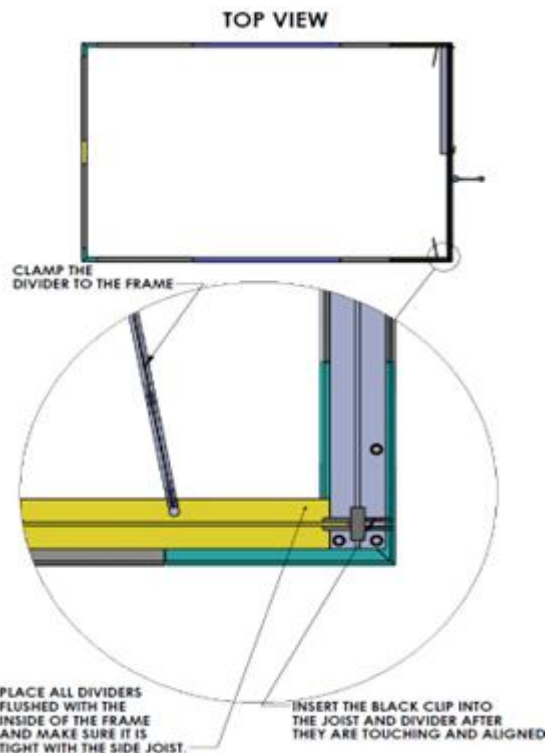

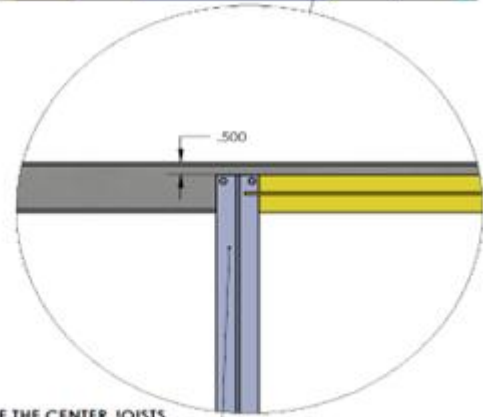
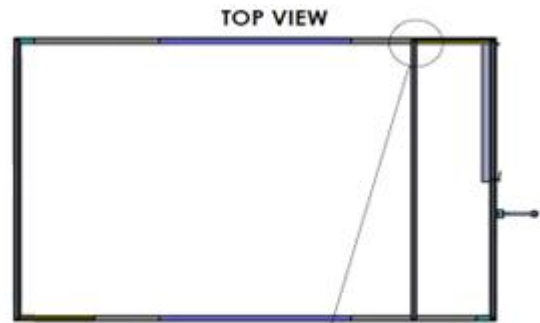
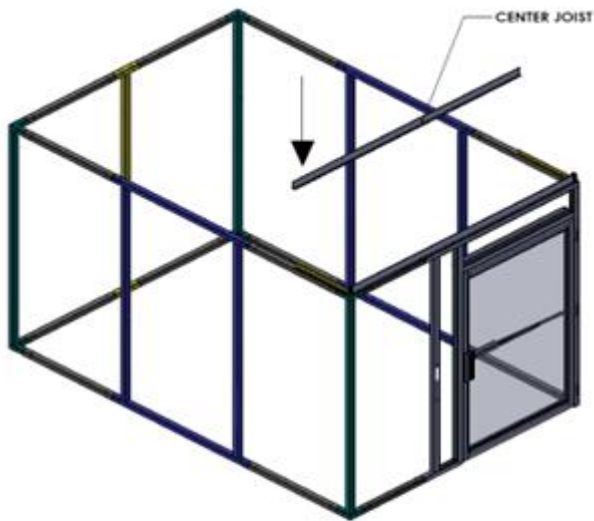

NOTE: CENTER JOISTS DO NOT HAVE HOLES ALONG THE LONG EDGE

STEP 5

ENSURE THE CENTER JOISTS ARE TIGHT NEXT TO THE DIVIDER AND FLUSHED WITH IT

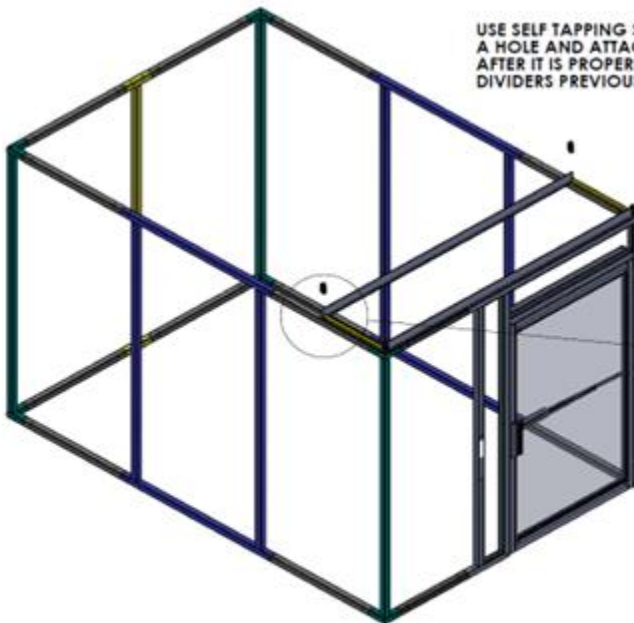

USE SELF TAPPING SHEET METAL SCREWS TO DRILL A HOLE AND ATTACH THE JOIST TO THE FRAME AFTER IT IS PROPERLY SPACED WITH THE DIVIDERS PREVIOUSLY INSTALLED

INSERT THE BLACK CLIP TO THE CENTER JOIST AND DIVIDER AFTER THE CENTER JOIST IS ATTACHED TO THE FRAME

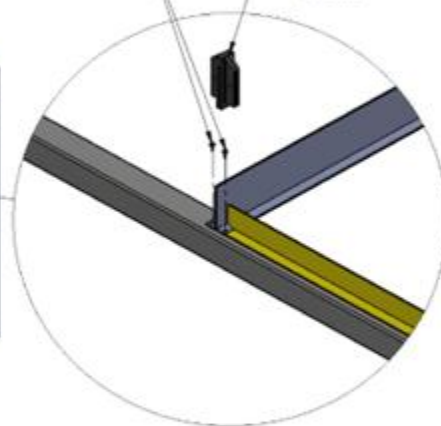

SCREW ON BOTH ENDS

STEP 6

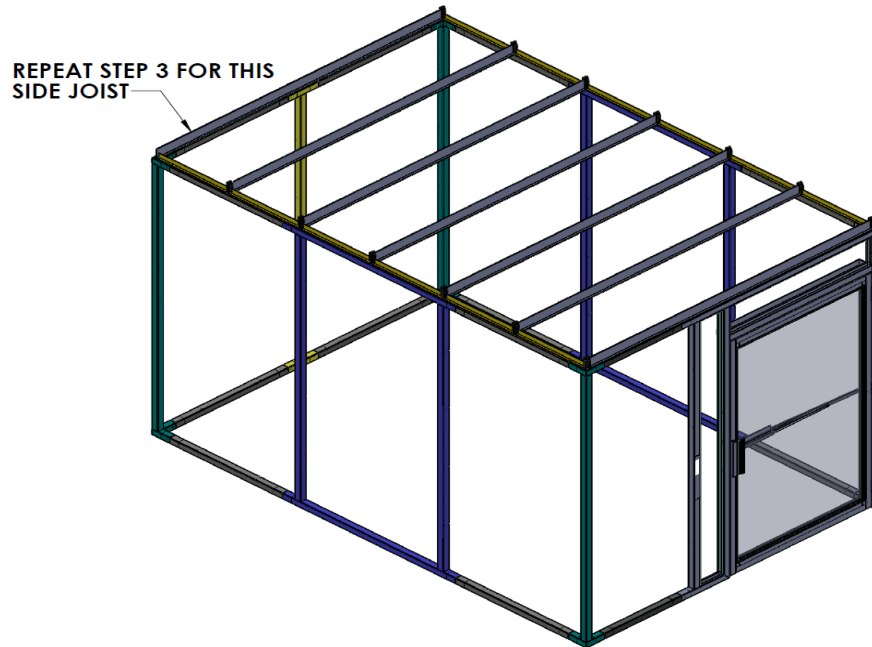

REPEAT STEPS 4-6 TO COMPLETE THE INSTALLATION OF THE CENTER JOISTS AND OUTER DIVIDERS

Use of the Spacer

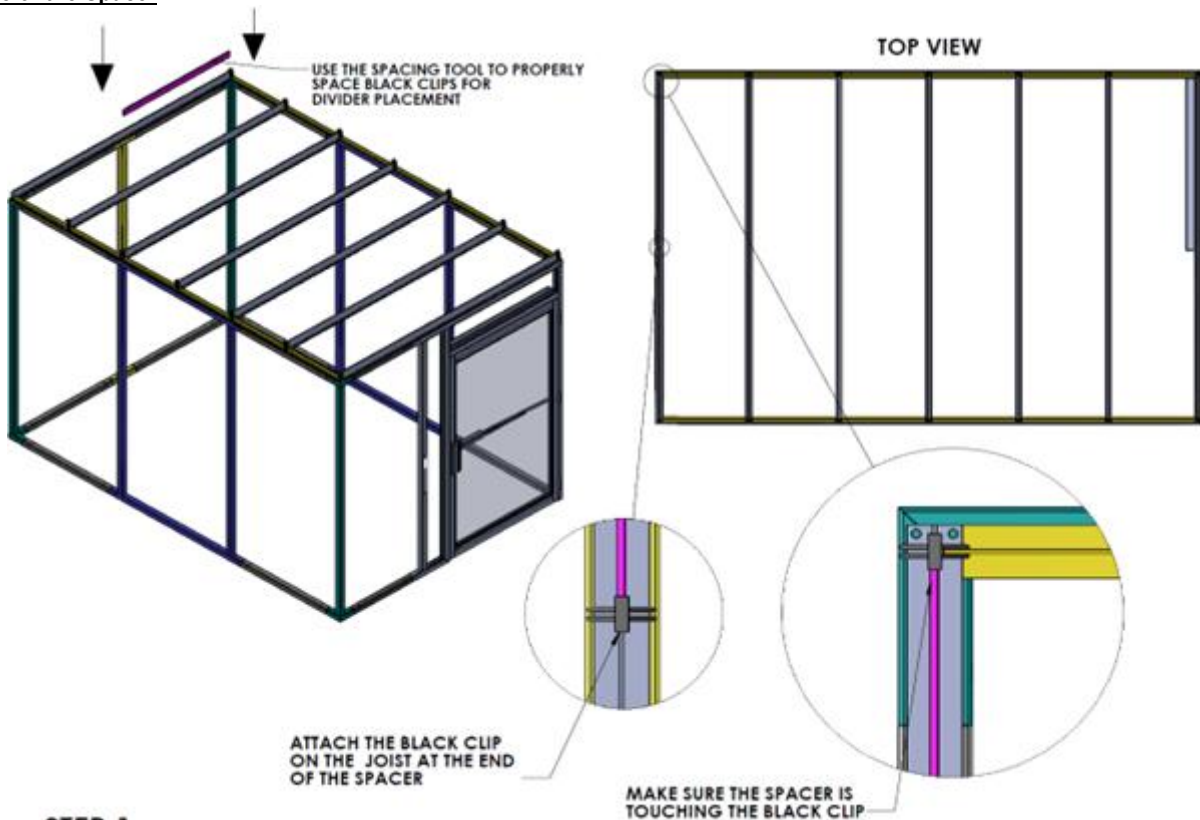

STEP 1

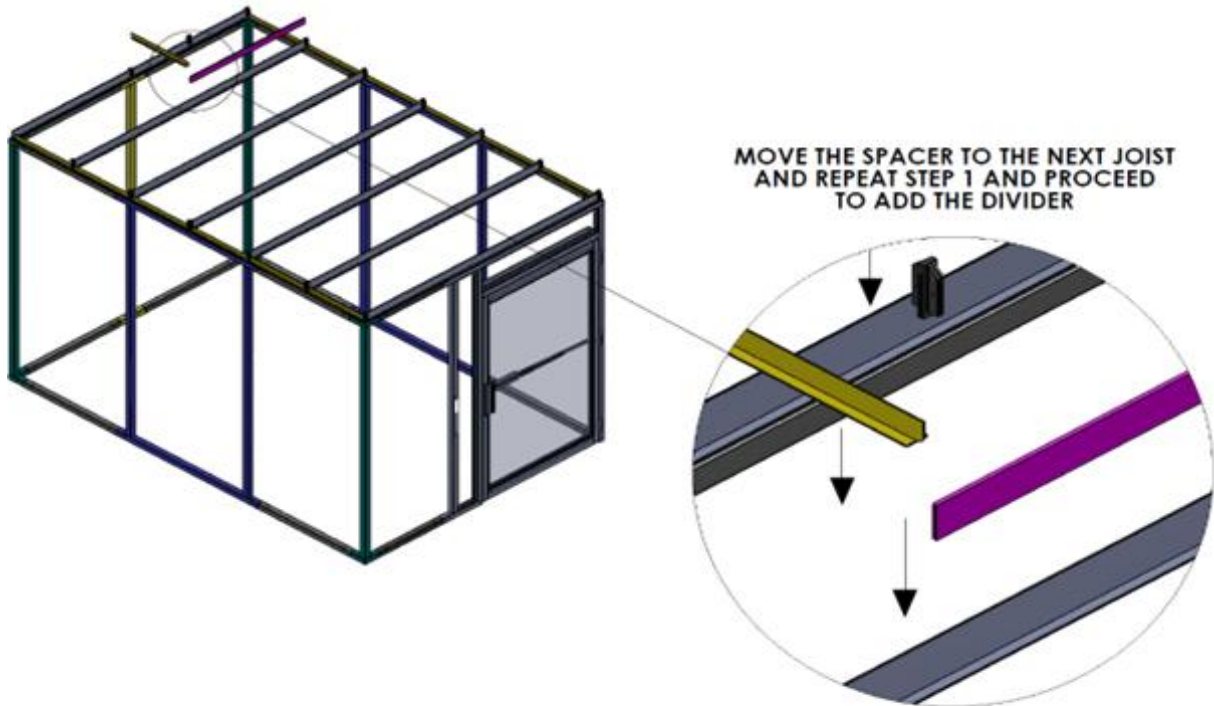

STEP 2

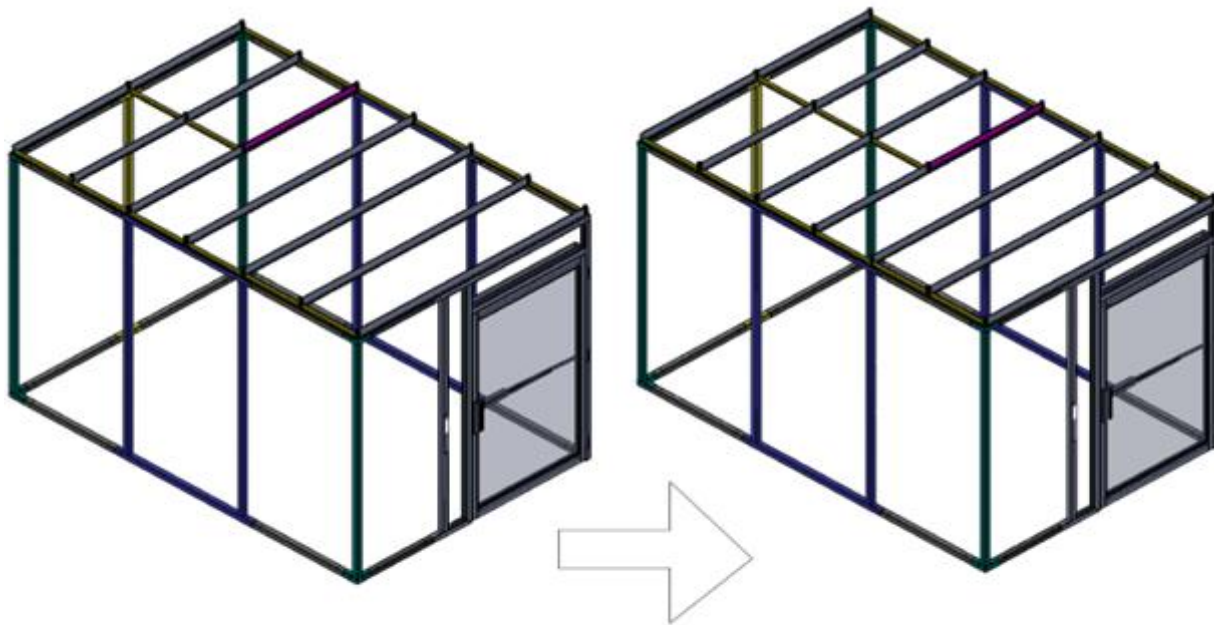

REPEAT STEPS 1-2 UNTIL CEILING GRID IS COMPLETE

STEP 3

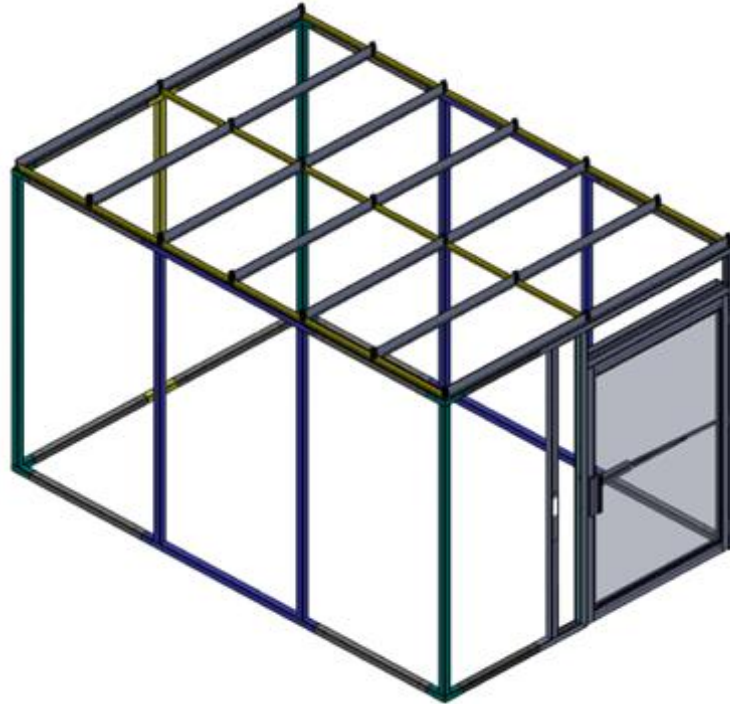

Support Bar Installation

The flat support bars with the notches will fit over the black clips and spaces the joist evenly. Bolt the overlapping sections together.

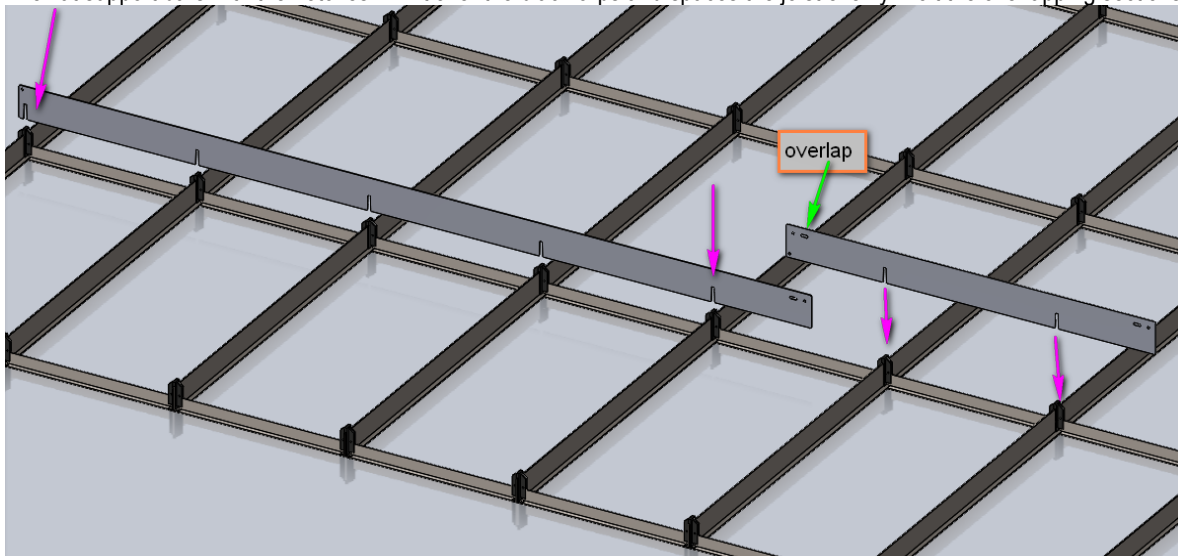



Installing the Top Trimming

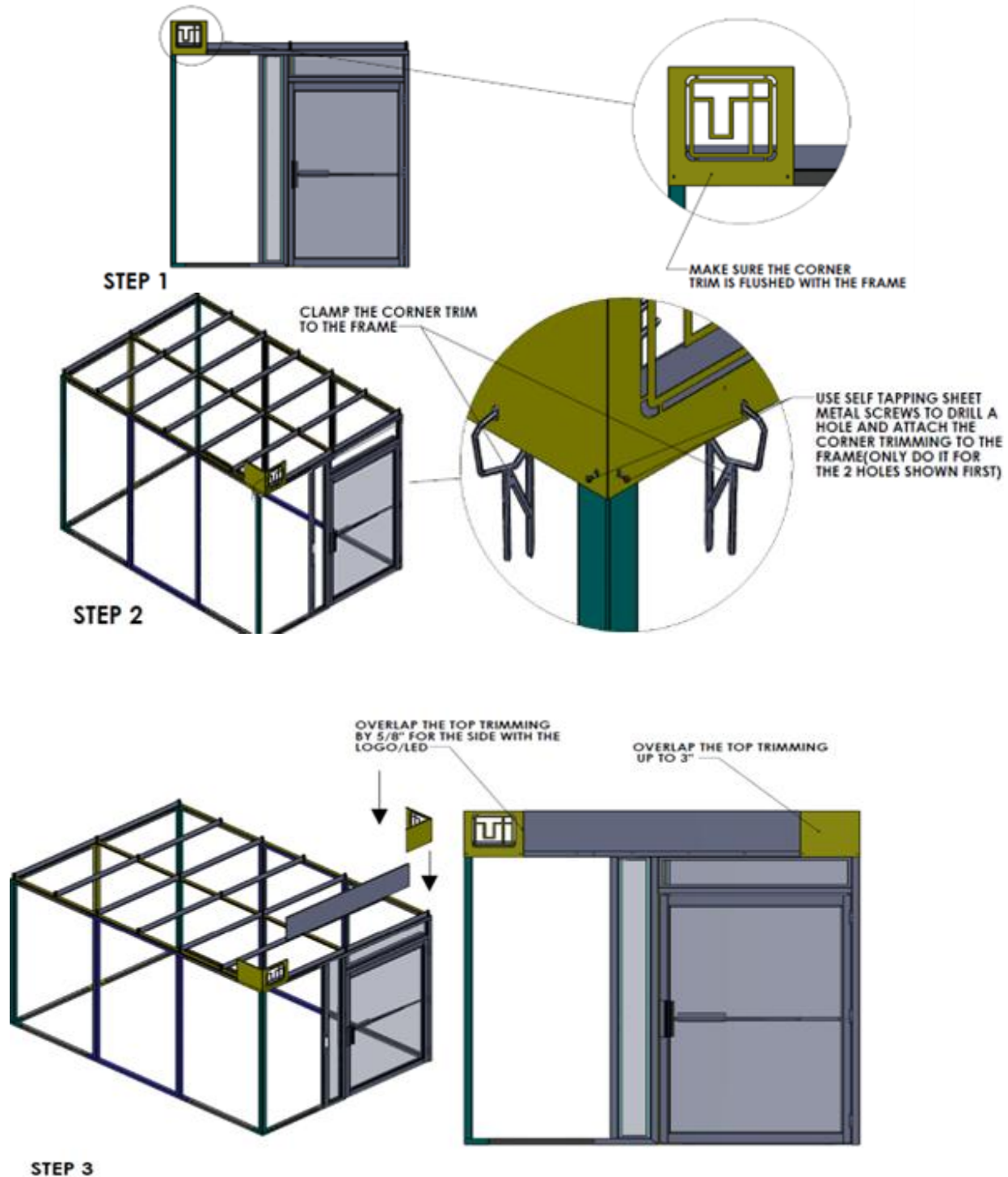

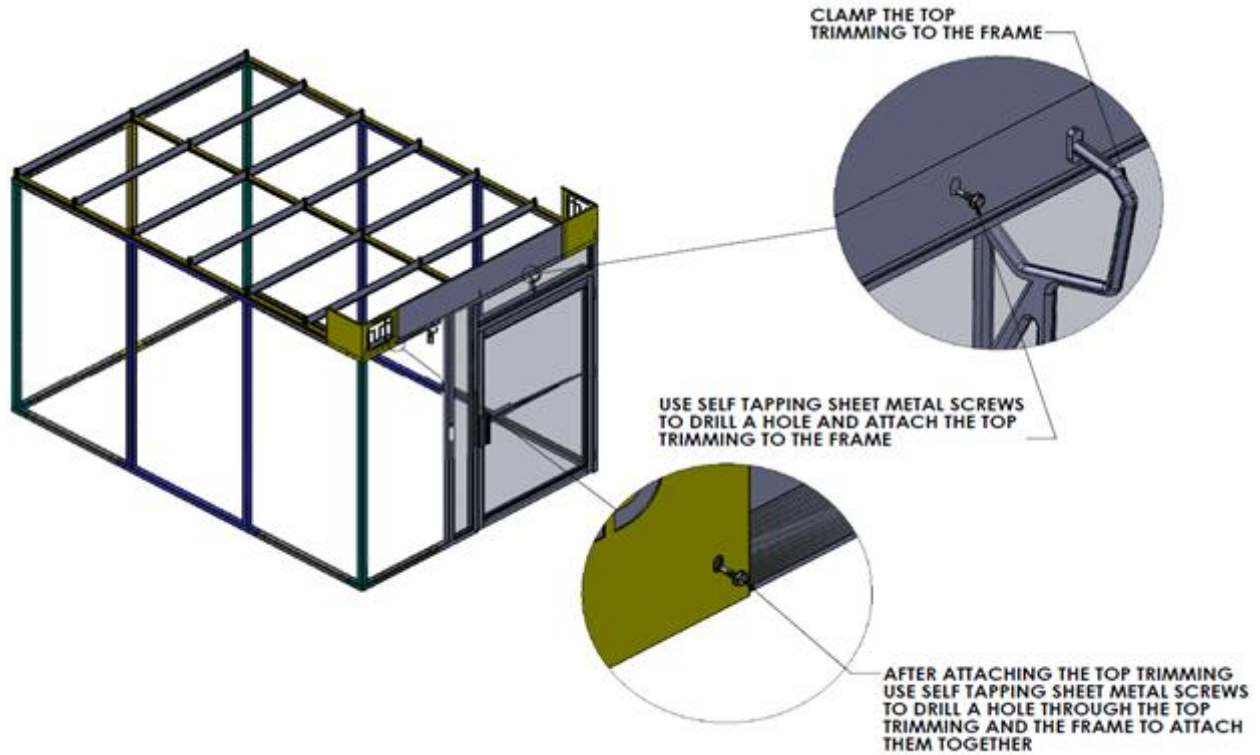

STEP 4

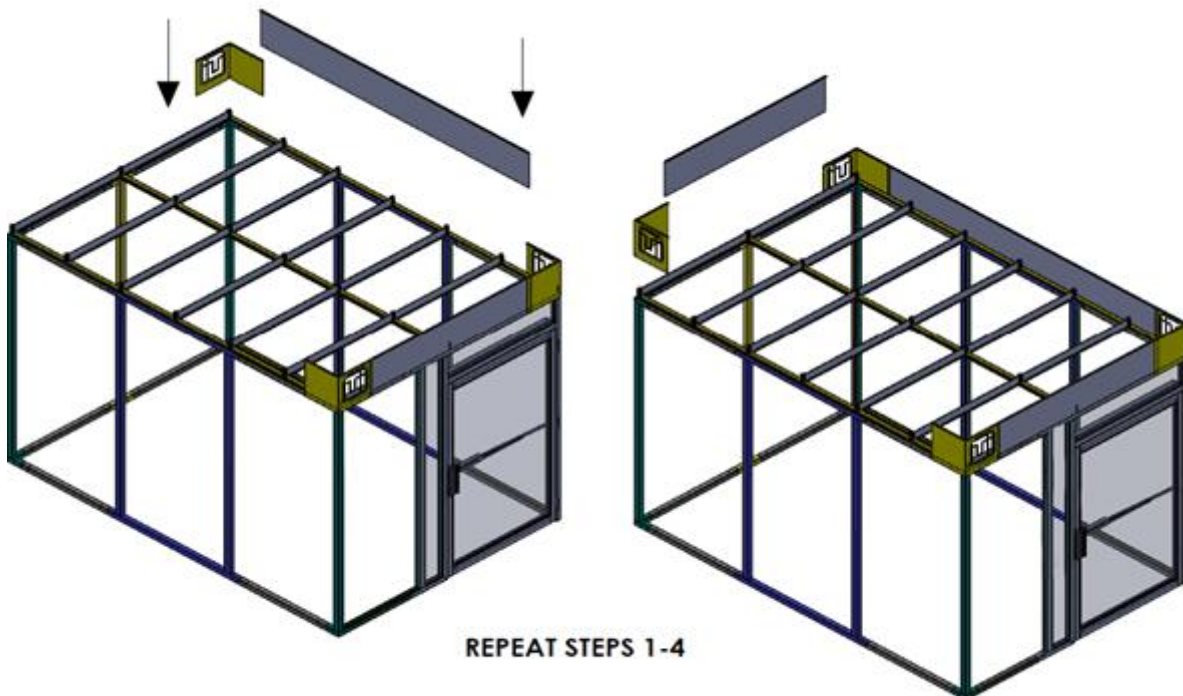

STEP 5

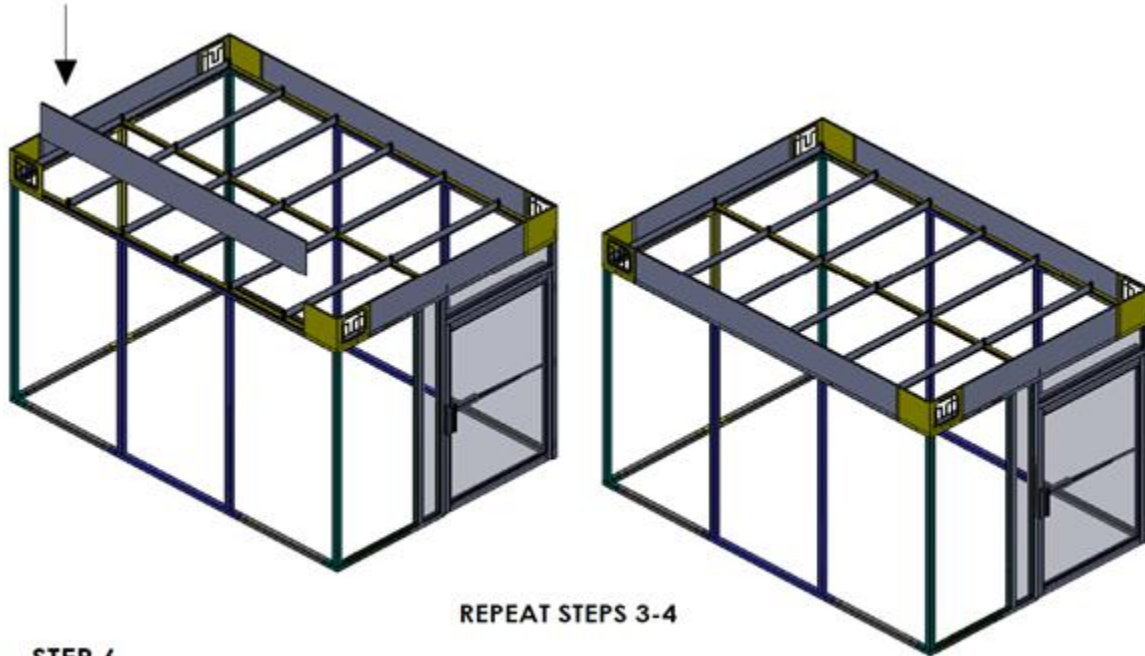

STEP 6

Installing Ceiling Modules

**DROP CEILING ACCESSORIES
ONTO THE OPENINGS**

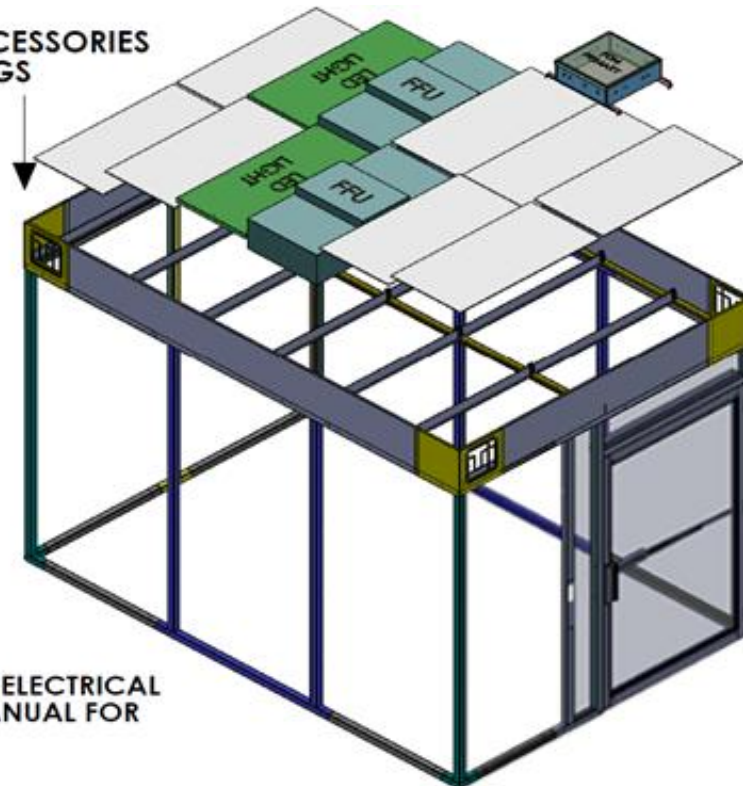

**NOTE: REFER TO THE ELECTRICAL
SECTION OF THE MANUAL FOR
WIRING DETAILS**



Use blank ceiling panels to fill any empty ceiling bays. The modules and ceiling panels simply rest on the flange of the ceiling joists and dividers. Typically, no fasteners are required. Refer to the electrical section at the end of the manual to see the wiring details and how to attach the PDM.



If blank ceiling panels lift when the cleanroom is pressurized, special clips are available to hold the panels down. Please call Terra for assistance.

Installing the Wall Panels



Wall panels are shipped with a protective, peel-off paper. Cut the paper to allow the panels to be installed with the protective covering intact.

The wall panels are held in place by pairs of opposing stainless steel trim strips that are attached to the inside edge of the frame.

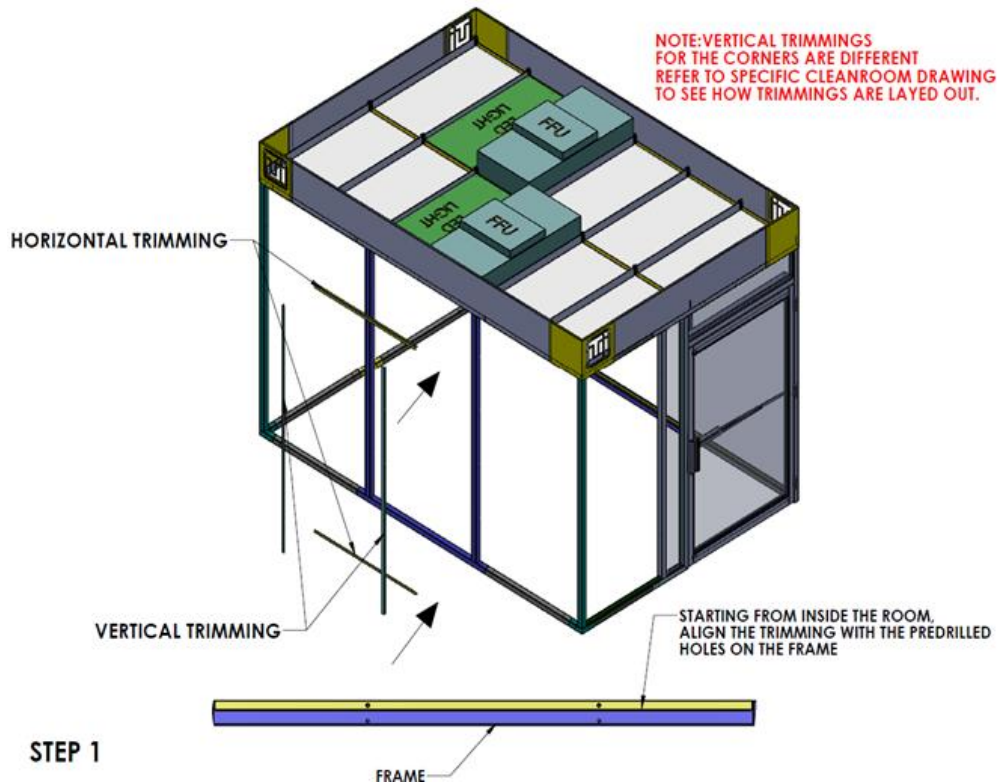

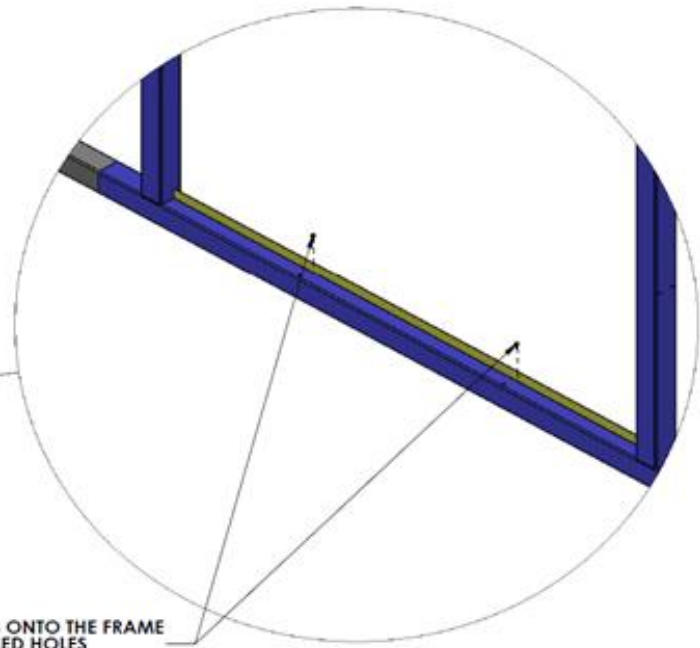
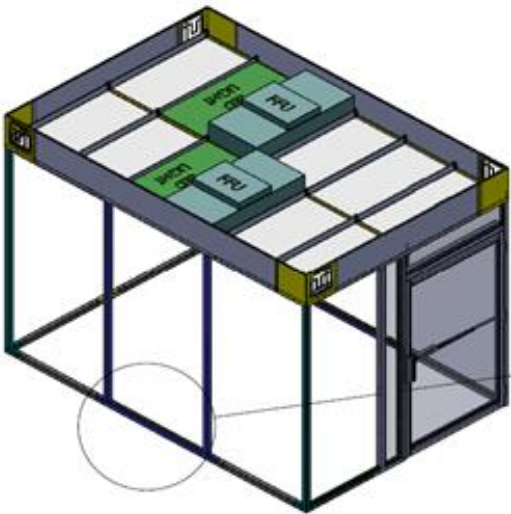
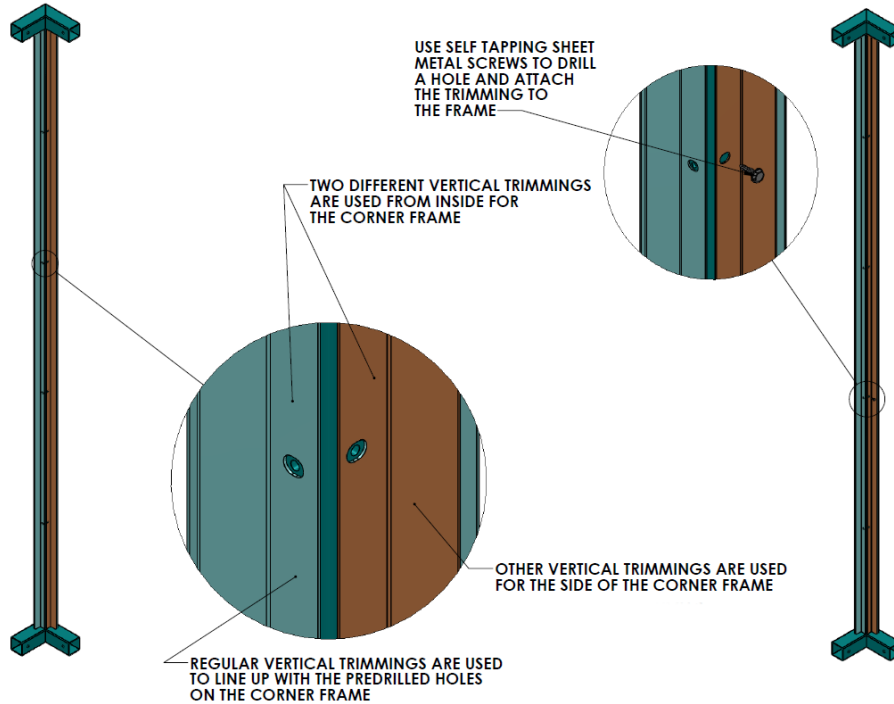

SCREW THE TRIMMINGS ONTO THE FRAME THROUGH THE PREDRILLED HOLES

STEP 2

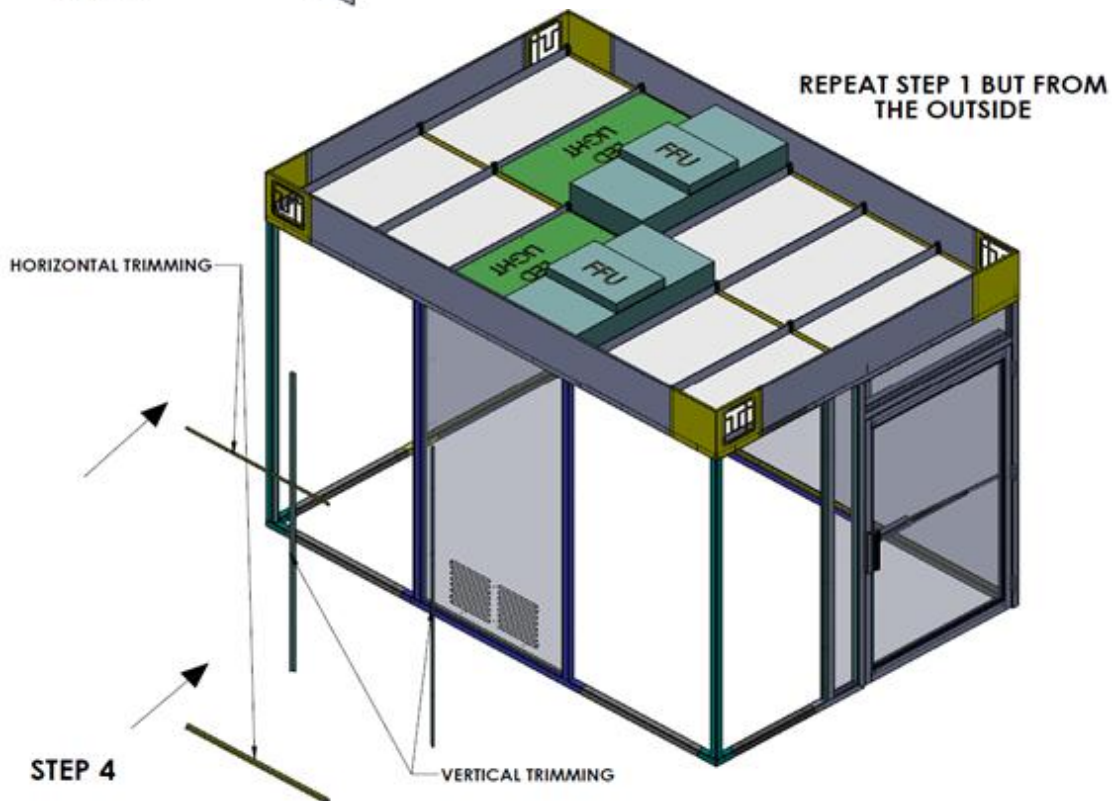
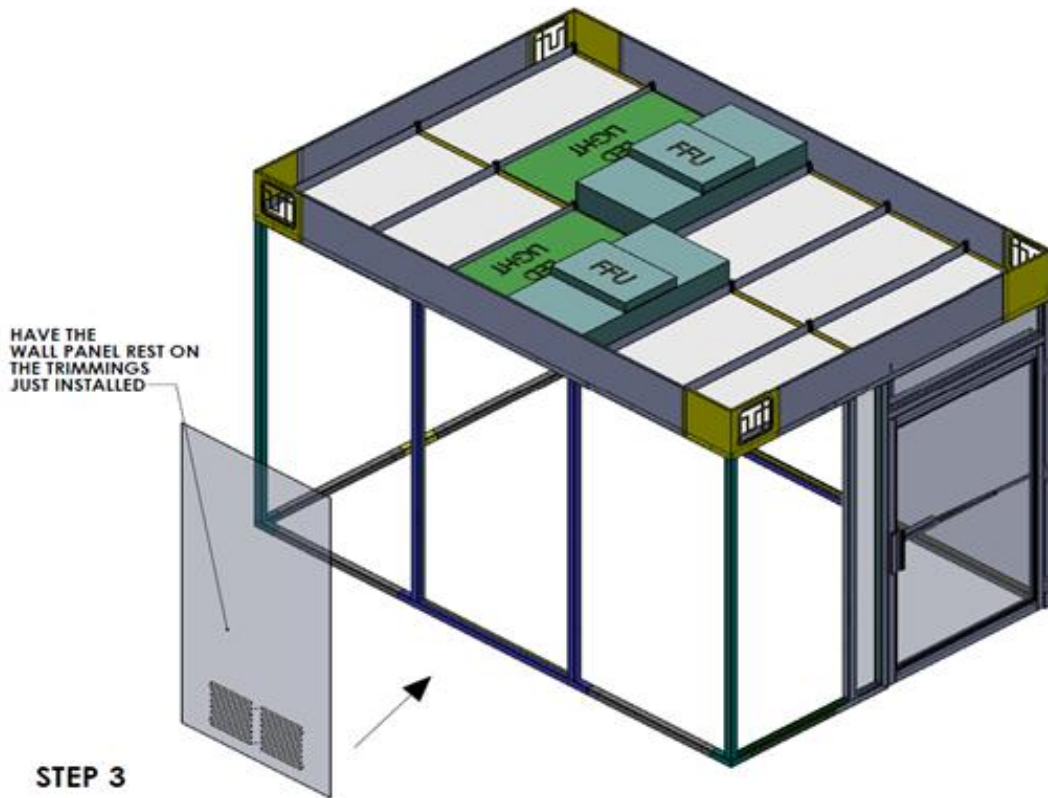

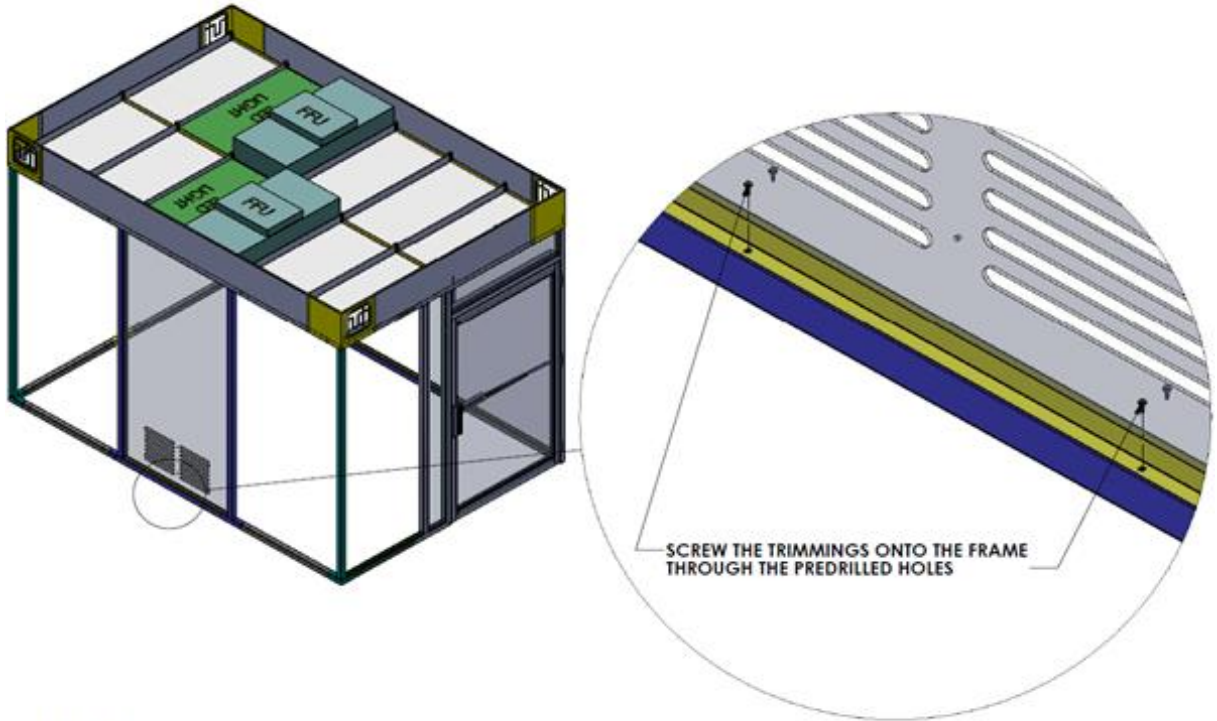

STEP 5

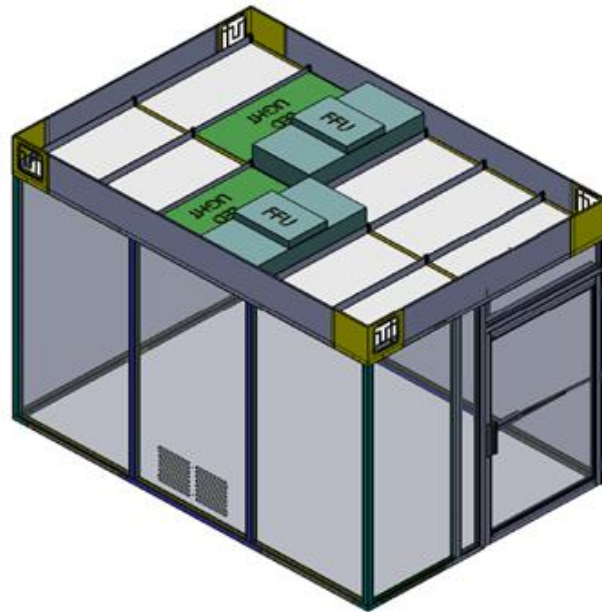

REPEAT STEPS 1-5 FOR THE REMAINING WALL PANELS



In most applications, the positive pressure generated by the fan/filter units will prevent any outside air from entering the cleanroom. If an air-tight seal is required, seams may be sealed with a suitable caulking or other sealant.

Fire Sprinkler System Installment

Once the cleanroom is set up, an ideal place for a fire sprinkler can be determined. Mark the desired location of the sprinkler system on a ceiling panel with tape or a pen/marker. Then, drill a 7/8" diameter hole into the ceiling panel. Install the brackets loosely on the two joists adjacent to the ceiling panel, which has the new hole for the sprinkler.

Put the sprinkler head under the ceiling panel in the hole from the cleanroom side and then screw the 1/2" NPT (National Pipe Taper), 2" long coupling on the top side of the ceiling panel. The 2" long coupling will prevent the sprinkler head from falling through the ceiling panel as the brackets are positioned. Thread the 1/2" NPT nipple on the coupling and then thread the flexible hose assembly (Figure A). Next, slide the brackets in a position so they align with the sprinkler head, then clamp the reducing nipple (the 5 1/2" metal piece that is part of the hose assembly {item 6, Figure A}) in place and then tighten the wing nut of the brackets to hold the assembly in position. For any further configurations, consult your specialized contractor.

COMPONENTS:

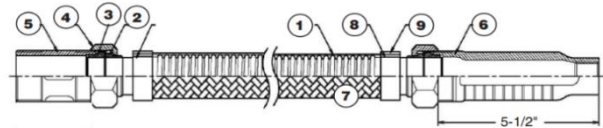

1. FLEXIBLE TUBE	304 STAINLESS STEEL
2. ISOLATION RING	NYLON 66
3. SEALING GASKET	EPDM
4. NUT	ZINC PLATED STEEL
5. NIPPLE 1"	ZINC PLATED STEEL
6. REDUCING NIPPLE	ZINC PLATED STEEL
7. BRAID	304 STAINLESS STEEL
8. COLLAR RING (INNER)	304 STAINLESS STEEL
9. COLLAR RING (OUTER)	304 STAINLESS STEEL
10. SQUARE BAR	ZINC PLATED STEEL
11. CENTER BRACKET	ZINC PLATED STEEL
12. 4" END BRACKET(S)	ZINC PLATED STEEL

CHARACTERISTICS:

- Minimum bend radius Braided 3" (230 mm)
- Flexibility Type: Limited

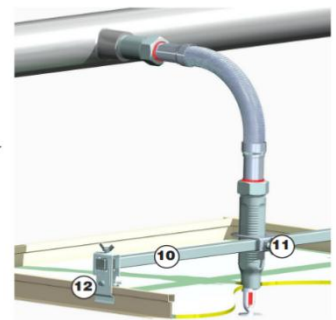

Figure A: Fire Sprinkler Install

How to Install Bracket for Flexible Hose Assembly



[Flexible Fire Sprinkler Drop Hose Braided/Unbraided - YouTube](#)

Fire Sprinkler System

The turnkey cleanroom fire suppression system is an accessory that can be added to your cleanroom for precautionary fire safety. The system is designed in accordance with NFPA 318 in mind. Included in the kit are the sprinkler heads, piping, and connectors. A sprinkler is placed in the cleanroom ceiling panel, typically centered in the room, to maximize coverage area. The fire suppression system is suggested for cleanrooms under 300 square feet, installed in a non-hazardous location. For cleanrooms that are larger than 300 square feet and located in hazardous or seismic-rated locations or containing volatile or explosive chemicals, please contact a local safety officer to determine the appropriate fire suppression system.



3.0 Electrical Wiring

6600-20B-VL Power Supply Unit (PSU)

- A. Power Strip
- B. NEMA 5-15P plug (loose)
- C. Coiled Conduit + 3-conductor cable
- D. NEMA 5-20R receptacle + junction box
- E. NEMA 5-20P plug (pre-wired)
- F. Rocker Switch



Figure B: Power Supply Unit 6600-20B-VL Contents



Installing the Power Supply Unit (PSU)



Each PSU has a maximum capacity of (3) FFUs and two (2) light fixtures

1. Punch out the precut knock outs in the door frame segment for the power supply.
2. Use a step drill bit to drill out the side joists aligning with the holes in the top of the door frame to make room for the conduit.
3. Uncoil the conduit and thread the wiring conduit up through the frame using some spare wire to the top of the frame member where the PSU will be mounted.
4. Wire and mount the rocker switch inside the door frame knock-out (Figs. C/D); use washers or spacers from switch hardware if a flush fit is desired.



Figure C: Switch Front



Figure D: Switch Back (cover plate removed)

6. Install the provided NEMA 5-20R single-gang receptacle and junction box at the top end of the conduit.
7. Recoil the conduit and complete any remaining frame and ceiling installation steps **before proceeding to the final steps.**
8. Connect the provided power strip to the conduit junction box and place the power strip on one of the blank ceiling panels.
9. Fasten back plate to door frame reverse opening.
10. If necessary, swap the pre-wired NEMA 5-20P plug with the loose provided 5-15P plug
11. Plug the FFU and LED panels in to the power strip.
12. Turn on the power switch on the multi-outlet power strip (no power should be supplied at this point).
13. Once the power supply is installed and the cleanroom has been assembled, plug the cleanrooms PSU into your buildings wall outlet.

If the cleanroom was specified with more than three (3) FFUs, a second Power Supply Unit is required and is included in the cleanroom order. The second PSU should be installed in a similar manner to the primary PSU.

Light Panel Wiring



Disconnect the unit from the electrical power source before attempting any service.

To preserve the UL listing of Terra Fan Filter Units, Terra must configure them for hard-wiring. Cords are dressed to simplify this operation, which typically does not require an electrician.

1. Remove the cover plate on the LED light panels
2. Punch out the pre-cut knock out and thread the power cable in
3. Match the white neutral wires, match the black line wires, and strip a half inch off the ends
4. Twist the stranded wire and the solid wire together
5. Screw wire nuts on to the line wire pair and the neutral wire pair until it bottoms out
6. Twist the green ground wire and the cover plate ground wire together and insert them into the Terminal Block
7. Replace the cover plate

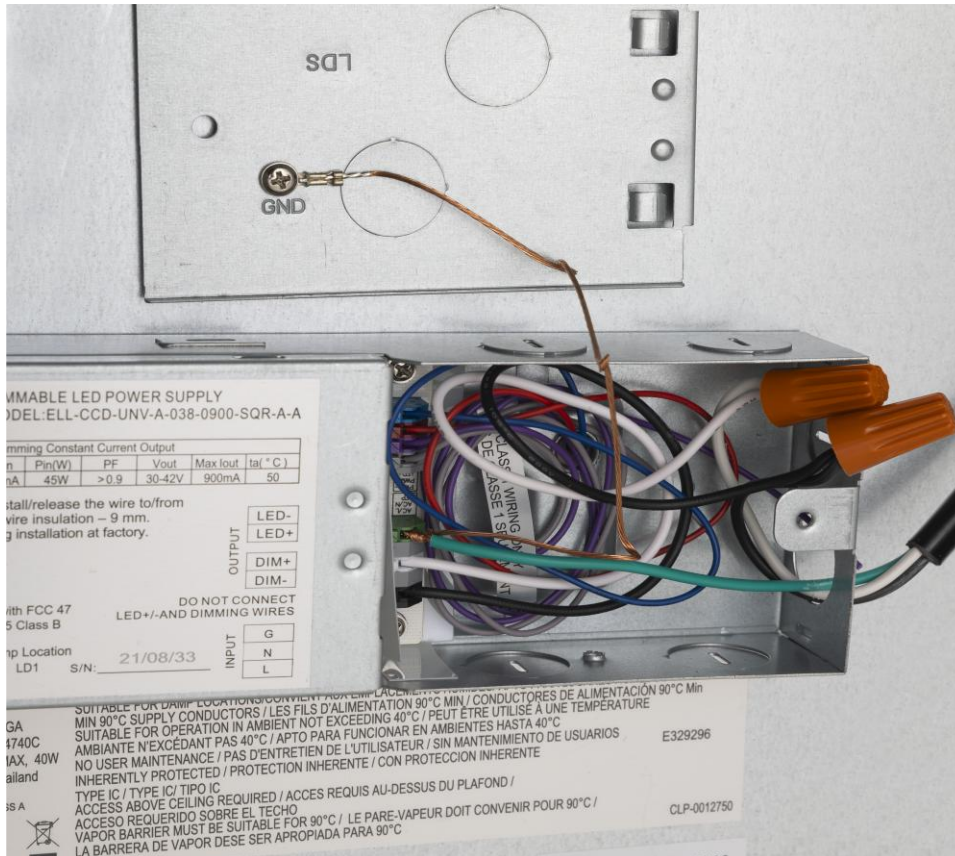



4.0 Service and Maintenance



WARNING

Disconnect the unit from the electrical power source before attempting any service.

An on/off switch controls the lights and the fan/filter units. The switches are generally mounted on the frame upright adjacent to the front access door.

Fan/filter units feature 3-position speed controls. All FFUs are factory-set at medium speed, which provides the 100 fpm air speed typically required for cleanroom operation.

Cleaning and Sterilization

Use a clean, non-shedding cloth (polyester wipers are recommended) and wipe surfaces in slow, unidirectional motions, folding the soiled surface of the cloth portion to trap contaminants after each pass. Avoid circular motions when cleaning. If cleaning with isopropyl alcohol or a similar cleaning agent, perform a full wipe-down of the sanitized area with deionized water.

The filters provide effective operation for years under typical operating conditions. In fact, filter efficiency increases as the filter captures more and more particles. The filter does not require replacement until the backpressure it generates increases to the point that the system can no longer provide an adequate airflow velocity to maintain required particle counts. To monitor this condition, periodic testing with a particle counter is recommended.

Wipes

Wipes are used more frequently than any other cleaning product or tool. Selection of wipes should be based on intended usage. When selecting wipes, you should consider things such as particle-shedding properties, chemical residue of the wiper content, static properties, absorbency and size. Wipe in one direction from left to right. Use slightly overlapping strokes. Remove surface spots with commercial cleaner and woven polyester wipes.

Cavicide, Caviwipes, and similar products contain ethylene glycol and benzethonium chloride, which are caustic chemicals that corrode stainless steel if not rinsed with water. After disinfecting with ethylene glycol or benzethonium chloride products, the affected area must be fully wiped down with deionized water and dried.



CAUTION

Always check chemical compatibility before cleaning plastic surfaces. Although vinyl and polyurethane withstand exposure to a wide range of common cleaning agents, repeated exposure to strong chemicals can cause damage.

Vacuums

There are a variety of different Vacuums available for your cleanroom. Selection of a vacuum will depend heavily on the application and the type of cleanroom you have. With all different types of sizes and filtration systems, select the one you feel would best suit the cleaning needs of your room. Refer to the Parts & Accessories section. For more information log on to our website at Terrauniversal.com



Mini-Environment Cleaning Kits

The ITW Tex wipe Mini Environment Cleaning Kits are ideal for cleaning corners and difficult-to-reach locations inside the cleanroom. The kits include a cleaning tool (18" and 24" handles, 1 polyester foam pad, and 6 mop covers), one production bag of dry and pre-wetted wipers and an informational brochure with instructions on how to clean your equipment.

Designed to facilitate cleaning, the mop head has a low, flat profile with rounded corners and is totally autoclave able. The swivel joint allows the user to reach inaccessible areas and replaceable foam pad ensures that the mop cover conforms to the surfaces that are being cleaned. The polyester knit fabrics used for the wipers and mop covers will not contaminate isolator surfaces when used in cleaning and disinfection operations.

Replacing Light Fixtures

Disconnect system power. Disconnect the power supply cables and lift the light fixture out of the ceiling grid. Carefully lower the new light fixture into the ceiling bay and reconnect the wiring (refer to **Section 2.0 Installation**). See **Section 7.0** for replacement parts.

Filter Replacement



The standard filter is protected with an expanded metal face screen. This is never to be used to handle the filter. It is only for protection against an accidental touch of the filter. Handle the filter only by the frame.

CAUTION

1. Disconnect the yellow power cable and remove unit from ceiling (see next page for recommended procedure).
2. Remove the 10 screws holding the HEPA / ULPA filter to the lid assembly.
3. Lift the lid assembly off the HEPA / ULPA filter (see figure below). Discard the used filter as per applicable regulations.
4. Carefully attach the new filter, being sure not to touch or otherwise damage the filter face.
5. Lift out the old pre-filter and drop in the new one.
6. Position the unit back in the ceiling grid and reconnect the unit to its power supply.

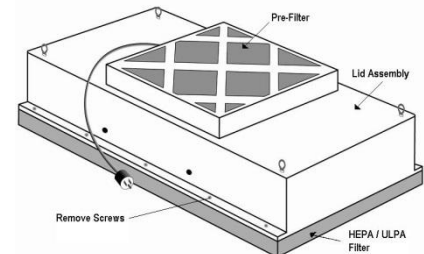

Figure 8



Carefully inspect the new filter for any visible damage prior to replacing.

NOTE



Removing the Fan/Filter Unit from the Cleanroom Ceiling Grid



WARNING

Disconnect the unit from the electrical power source before attempting any service.

1. Disconnect the fan/filter unit from the power strip and roll up the power cord.
2. Attach double stick tape to all four sides of a polypropylene panel, as shown at right.
3. Place the polypropylene panel over the filter screen, making sure that it only adheres to the screen without overlapping the edges.
4. Push one side of the FFU up, rotate it 90° and lower it through the ceiling grid.
5. After replacing the filter, reverse these steps to reinstall the fan/filter unit in the ceiling grid.



Figure 9



Figure 10



Figure 11



Figure 12

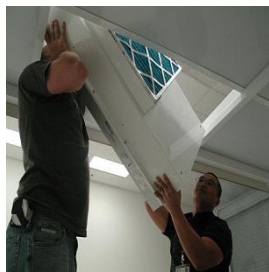

Figure 13



Figure 14



5.0 Specifications



Refer to the original order form for the exact specifications/configuration of your cleanroom.

Acrylic

Operating Temperature: 32°F to 104°F

Acrylic is more rigid than acetates or vinyl, and is much more resistant than glass to thermal shock. The tensile strength of this material is 10,000 PSI at room temperature; however, when continuously loaded, imposed loading should not be allowed to exceed 750 PSI. These panels are rated for operation in an environment with a relative humidity of up to 92%. Exposure to direct sunlight may cause the material to warp and distort.

The self-ignition temperature is 830 degrees Fahrenheit (443 degrees Celsius) measured in accordance with ASTM D-1929. The products of combustion, when sufficient air is present, are water and carbon dioxide. However, as with many other common combustible materials, when sufficient air is not present during combustion, toxic carbon monoxide will be produced.

Static-Dissipative PVC

Operating Temperature: 32°F to 100°

Static-dissipative PVC features surface resistance between 106 and 108 ohms/square—much less than that of other treated plastics. Tests show that when 10KV is applied to the surface, electrostatic potential remains less than 15V, and static decay time is less than 1 second. And because this plating offers such effective static dissipation, it will not attract dust or other contaminating particles that could damage sensitive microelectronic components.

In a test conducted in accordance with Mil-B-81705B, the plating was conditioned for 24 hours at a relative humidity of 12% and a temperature of 70 degrees F. The sample exceeded the 2.0 second static decay requirement to zero as specified; in fact, it had a decay time of 0.01 seconds for each measurement taken! It had a surface resistivity of 1.7×10^7 ohms per square on one side and 2.8×10^7 on the other.

This plating is also durable. It features superb resistance to UV radiation; tests have indicated no loss of static protection after 500 hours of continuous exposure to a fadeometer. In temperature tests, it maintained its dissipative properties after 100 cycles of temperature fluctuations from -5°C to 60°C . It is also completely noncombustible.

The plating also offers all of the chemical-resistance of standard PVC plating. It remains unaffected by a wide range of chemical solutions.

UL-Listed Components

If your order included UL documentation (Cat. # 6600-33), labels indicating UL-listed components can be found on the main power switch.



Fan Filter Units

Dimensions	23.63"W x 47.63"D x 13"H
Weight	71 lbs. (32 kg)
Avg. Airflow	717 CFM
Airflow Speed	115 fpm @ High 102 fpm @ Medium 93 fpm @ Low
Run Amps	4.3 amps @ High 3.5 amps @ Medium 3.3 amps @ Low
Power Requirements	120VAC, 60Hz
Sound Level	Approximately 50 dBA on low speed measure at 30 in. from the filter face, with the fan delivering an average airflow velocity of 90 FPM (0.45 m/s)
Housing	Both the fan plenum and filter housing have a powder-coated steel exterior
Pre-Filter	20" x 20" x 1" MERV 7 pleated cotton/synthetic fibers
HEPA Filter	Factor tested and rated 99.99% efficient in removal of particles 0.3 micron and larger; leak free in accordance with the latest I.E.S.T. Recommended Practices
Filter Media	Micro-glass fiber with hot melt separators, sealed to the aluminum housing
Filter Screen	Perforated stainless steel
Fan	Direct Drive; forward curve centrifugal type with permanently lubricated sealed ball bearings
Motor	Permanent split capacitor type rated for continuous duty furnished with thermal overload protection and a three-speed switch



6.0 Spare Parts and Accessories

Filters	
HEPA Filter (for 2' x 4' FFUs)	TUI # 6601-25
ULPA Filter (for 2' x 4' FFUs)	TUI # 6601-28
MERV 7 Pre-filter (20" x 20")	TUI # PA04599
Lighting	
Light Panel (2' x 4')	TUI # 3800-41B
Wipes	
Cotton Wipes 9" X 9"	TUI # 5605-07
Cotton Wipes 12" X 12"	TUI # 5605-02
Polyester Wipes 9" X 9"	TUI # 5605-00
Polyester Wipes 12" X 12"	TUI # 5605-08
Vacuums	
MicroVac – Portable Vacuum Cleaner	TUI # 5100-00 TUI # 5100-00-220 (220 VAC)
HEPA – Filtered Vacuum Cleaner	TUI # 1001-00
ULPA – Filtered Vacuum Cleaner	TUI # 1764-00 TUI # 1764-00-220 (220 VAC)
Fire Sprinkler System	
Turnkey Cleanroom Fire Suppression System	TUI # 6601-05



TUI # 6601-13 (Fan/Filter Units)
4-Pin Adapter Cable



TUI # 6601-14 (LED Lights)
3-Pin Adapter Cable



Installation and Operating Guide

ValuLine[®] Hardwall Modular Cleanroom

© Copyright 2026 Terra Universal Inc. All rights reserved. • Revised Feb. 2026 • Document No. 1788-05

7.0 Warranty



<https://www.terrauniversal.com/warranty/>

*Thank you for ordering from
Terra Universal!*