

PIPETITE®



PIPETITE® FORMS A FLEXIBLE, SANITARY SEAL THAT
ALLOWS FOR PIPELINE MOVEMENT.

MATERIALS

- Hygienic white silicone and 316 stainless steel, compatible with cleaning solution

MODELS

- Pipetite® Standard, ReBoot®, Multi Grommet, and Flat have pre-drilled mounting holes
- All Pipetite products are self-sealing

SIZES

- Styles available to fit tube or pipe up to 15" in diameter

MORE INFO

- -40 to 500°F temperature rating
- Pipetite Standard and Grommet are IP34 rated
- Mini Grommets are NEMA rated for Type 4, Type 4X, and Type 6 enclosures
- Molded lines guide your cutting

APPLICATIONS

- Process and Clean Room Facilities: used on wall, floor, and ceiling penetrations, jacketed vessels, sheathed tanks, and hard to reach areas
- HVAC & Plumbing: used on conduit and piping to seal gaps and protect from condensation
- Electrical: used to organize cabling, and protect from moisture
- Construction: used to seal gaps, cover holes, and as a replacement for roof flanges
- IT: used to organize cabling and seal server racks from debris and other elements



PIPETITE®

DIMENSIONS

PRODUCT LINE



STANDARD



FLAT

SIZES 2, 3, AND 4 ARE ALSO AVAILABLE IN GRAY



REBOOT®



SLEEVE BOOT



SLEEVE REBOOT®



GROMMET



MINI GROMMET



MULTI GROMMET

STANDARD FOR NEW INSTALLATIONS

Size	Tube OD	A	B	C	D	Anchors	Item
1	0.00-1.00	1.18	2.24	2.76	2.05	4	PT1-000
1	0.75	1.18	2.24	2.76	1.42	4	PT1-075
1	1.00	1.18	2.24	2.76	1.26	4	PT1-100
2	0.00-2.50	2.52	3.58	4.17	2.36	4	PT2-000
2	1.00	2.52	3.58	4.17	1.89	4	PT2-100
2	2.00	2.52	3.58	4.17	1.38	4	PT2-200
3	0.00-3.74	3.94	5.04	5.79	3.07	6	PT3-000
3	3.00	3.94	5.04	5.79	1.61	6	PT3-300
4	2.76-5.31	5.51	6.61	7.36	2.52	6	PT4-000
4	4.00	5.51	6.61	7.36	2.05	6	PT4-400
5	3.94-7.09	7.09	8.39	9.33	3.15	10	PT5-000

ALL DIMENSIONS ARE SHOWN IN INCHES. 19 GAUGE MOUNTING RING WITH 0.177 DIAMETER BOLT HOLES. SIZES 1, 2, AND 3 ARE FULL CONES. SIZES 4 THROUGH 9 ARE NOT AVAILABLE AS FULL CONES. COLUMN D IS THE MAX HEIGHT.

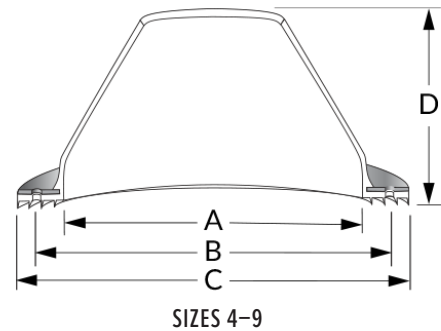
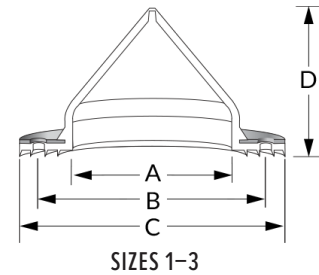

REBOOT® FOR EXISTING INSTALLATIONS

Size	Tube OD	A	B	C	D	Anchors	Item
2	0.00–2.50	2.52	3.58	4.17	2.36	5	PTR2-000
3	0.00–3.74	3.94	5.04	5.79	3.07	7	PTR3-000
4	2.76–5.31	5.51	6.61	7.36	2.52	7	PTR4-000
5	3.94–7.09	7.09	8.39	9.33	3.15	10	PTR5-000
7	4.92–10.83	11.02	12.25	13.28	5.12	14	PTR7-000
9	6.50–15.00	17.09	18.39	19.31	7.87	20	PTR9-000

ALL DIMENSIONS ARE SHOWN IN INCHES. 19 GAUGE MOUNTING RING WITH 0.177 DIAMETER BOLT HOLES. SIZES 2 AND 3 ARE FULL CONES. SIZES 4 THROUGH 9 ARE NOT AVAILABLE AS FULL CONES. SIZES 7 AND 9 CAN BE USED AS STANDARD OR REBOOT. COLUMN D IS THE MAX HEIGHT.

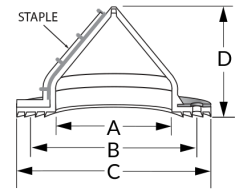

SIZES 2-3

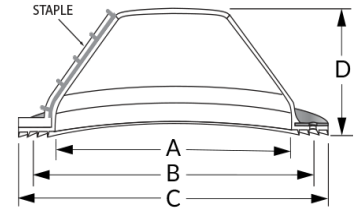

SIZES 4-9

FLAT FOR NEW INSTALLATIONS

	Tube OD	A	B	C	D	Anchors	Item	Item-Gray
1	0.00–1.00	2.76	2.24	2.76	.39	4	PTF1-000	N/A
2*	0.00–2.50	4.17	3.58	4.17	.39	4	PTF2-000	PTF2-GRAY
3*	0.00–3.74	5.79	5.04	5.79	.39	6	PTF3-000	PTF3-GRAY
4*	0.00–5.31	7.36	6.61	7.36	.39	6	PTF4-000	PTF4-GRAY

ALL DIMENSIONS ARE SHOWN IN INCHES. 19 GAUGE MOUNTING RING WITH 0.177 DIAMETER BOLT HOLES. COLUMN D IS THE MAX HEIGHT. *SIZES 2, 3, AND 4 ARE ALSO AVAILABLE IN GRAY

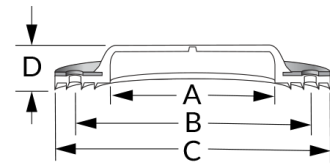

SLEEVE BOOT FOR NEW TUBE-IN-TUBE TRANSITIONS

Size	Sleeve OD	Tube OD	A	B	C	Item
1	4	0.0–3.5	3.54	4.02	4.41	PTS1-000
2	6	0.0–5.5	5.55	6.02	5.91	PTS2-000
3	8	0.0–7.0	7.76	8.23	7.52	PTS3-000

ALL DIMENSIONS ARE SHOWN IN INCHES.

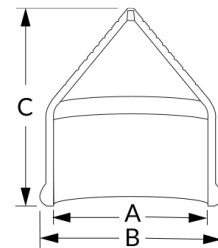

SLEEVE REBOOT® FOR EXISTING TUBE-IN-TUBE TRANSITIONS

Size	Sleeve OD	Tube OD	A	B	C	Item
1	4	0.0–3.8	3.82	4.21	4.57	PTSR1-000

ALL DIMENSIONS ARE SHOWN IN INCHES.

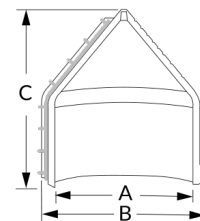

ANCHORS

FOR MOUNTING PIPETITE STANDARD, FLAT, MULTI GROMMET, AND REBOOT

Anchor	Surface Types	Item
1	CONCRETE, BRICK	PTA-1
2	PANEL WALLS, THIN WALLS, CONCRETE, BRICK	PTA-2



ANCHOR 1



ANCHOR 2

PIPETITE®

DIMENSIONS

GROMMET

FOR CABINETS, PANELS, AND ENCLOSURES

Size	Tube OD	A	B	C	Item
1	0.00–1.00	1.89	1.38	2.12	PTG1-000
2	0.00–2.56	3.23	2.75	2.50	PTG2-000
3	0.00–3.74	4.72	4.00	3.25	PTG3-000
4	2.76–5.31	6.30	5.75	2.50	PTG4-000
5	3.94–7.09	7.95	7.25	3.12	PTG5-000

ALL DIMENSIONS ARE SHOWN IN INCHES. GROMMETS FIT WALL THICKNESSES FROM 18 GAUGE TO 11 GAUGE (0.048 TO 0.120 IN). SIZES 1, 2, AND 3 ARE FULL CONES. SIZES 4 AND 5 ARE NOT AVAILABLE AS FULL CONES. COLUMN C IS THE MAX HEIGHT.

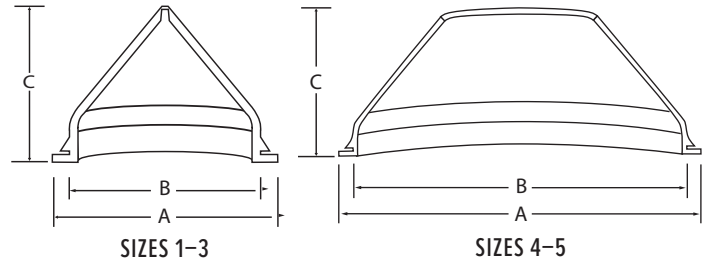

MULTI GROMMET

FOR MULTI-WIRE APPLICATIONS IN CABINETS OR WALLS

Size	Tube OD	A	B	C	D	Item
1	0.25–0.50	1.22	2.23	2.76	1.70	PT1-MG

ALL DIMENSIONS ARE SHOWN IN INCHES. 19 GAUGE MOUNTING RING WITH 0.177 DIAMETER BOLT HOLES.

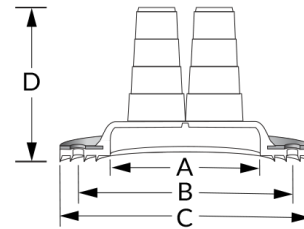

MINI GROMMET

NEMA RATED FOR TYPE 4, TYPE 4X, AND TYPE 6 ENCLOSURES

Size	Tube OD	A	B	C	Item
1	0.25	0.87	0.63	1.31	PTMG-1
2	0.31	0.87	0.63	1.25	PTMG-2
3	0.38	0.87	0.63	1.25	PTMG-3
4	0.50	0.87	0.63	1.12	PTMG-4

ALL DIMENSIONS ARE SHOWN IN INCHES. GROMMETS FIT WALL THICKNESSES FROM 18 GAUGE TO 11 GAUGE (0.048 TO 0.120 IN). COLUMN C IS THE MAX HEIGHT.

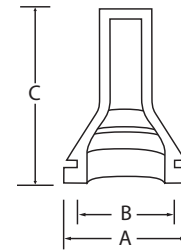

CSIDESIGNS.COM | 800.654.5635 | 417.831.1411 | SALES@CSIDESIGNS.COM
 SPRINGFIELD, MO | GRAND PRAIRIE, TX | DURHAM, NC | FRESNO, CA | KNOXVILLE, TN

PIPETITE® IS PROTECTED UNDER US PATENT NUMBERS
 9255412, 9206928, 9581271, 1000934, AND 10081947.

PIPETITE DATA SHEET—REV 08/25