

REGISTER
YOUR WARRANTY



Photos illustrating products are non contractual.

SANUVAIR® S300

AIR PURIFICATION SYSTEM WITH HEPA FILTER

Commercial/Residential Model



IMPORTANT SAFETY INSTRUCTIONS

READ AND SAVE THESE SAFETY INSTRUCTIONS BEFORE USING THIS PRODUCT.



Read and follow all instructions contained in the manual before using the product. Read the maintenance instructions before opening the UV unit or system. Failure to comply with these instructions may result in injuries or damage to the UV unit or system.

⚠ NEVER EXPOSE EYES OR SKIN TO AN OPERATING UV LAMP. ⚠

- Installation and servicing** of UV units or systems (in an air conditioning system or not) **can be hazardous**. Only **trained and qualified service personnel** should install, repair or service equipment.
- Untrained personnel** can perform **basic maintenance** functions such as replacing lamp(s) and/or filter(s). All other operations should be performed by trained service personnel.
- The unit is not to be used by persons (including children) with reduced physical, sensory or mental capabilities, or lack of experience and knowledge.
⚠ CAUTION: Unit is not a toy. Keep away from unsupervised children. Do not leave children unattended with the unit.
- DO NOT hang onto the UV unit or system.**
- Some UV units or systems could be heavy: Make sure you have a minimum of 2 people to safely move or install these UV units or systems, and make sure you adopt the most ergonomic position possible (use UV unit or system handles, if applicable).
⚠ CAUTION: Installing or maintaining heavy equipment, especially overhead, can cause back pain or other injuries.
- When installing or servicing an overhead UV unit or system, be careful not to fall off the stepladder. Furthermore, make sure the UV unit or system latches are always in place to prevent falling parts.
⚠ CAUTION: Some parts of some UV units and systems may open suddenly if the UV unit or system is installed high up without its locks.
- Units that are obviously damaged must not be operated.
- ⚠ CAUTION:** When working on the UV unit or system, observe precautions on the literature, tags and labels attached to the UV unit or system, and all other safety precautions considered as best practices in the HVAC industry, if applicable.
- When applicable, local regulation may comprise more restrictive installation and/or certification requirements. The aforementioned requirements prevail on those of this document and the installer agree to conform to these at his own expense.
- Follow all the safety instructions outlined in this document and respect all local and national codes applicable.
- All UV units or systems contain a UV-C source. Damage to the housing or unintended use of the UV unit or system may result in harmful UV-C leaks. UV-C may, even in little doses, cause harm to the eyes and skin.
- Never expose eyes or skin to an operating UV lamp.** Therefore, **before installing or performing maintenance** on the UV unit or system, **TURN OFF AND DISCONNECT** the UV unit or system **from all power sources** (there may be more than one switch to disconnect) and also disconnect the HVAC system, is applicable.
⚠ CAUTION: Electrical shock may cause injuries or possibly death. **FIRST AID INSTRUCTIONS:** If injured, consult a doctor.
- UV rays may damage certain types of filters (polymer or plastic); please keep the UV unit or system light away from shining directly on plastic.
- When installing or performing maintenance on the UV unit or system, it is recommended to **wear safety gloves**. In order to avoid reduced performance of lamp(s), **do not touch lamp glass without gloves**.
- Just like conventional fluorescent lamps, UV lamps contain a small quantity of mercury: if a lamp breaks, clean and **dispose of with care**. UV lamps can be disposed/recycled after use in the same way as any other fluorescent lamps. Contact and follow the specific instructions of your local and national authorities.
1. Dispose of unit or system according to the specific instructions and standards of your local and national authorities.
- Use only specified SANUVOX branded replacement UV lamps for your UV unit or system.** Use of any other lamps will void your warranty and can result in damage to the UV unit or system.
- Sanuvox UV units or systems are not waterproof. **DO NOT INSTALL OUTDOORS OR IN WET LOCATION** unless specified otherwise.
- Use of this unit or system supplements, but does not replace, infection control best practices. Users must follow all these practices, particularly with regard to cleaning and disinfecting surfaces.

SAVE THESE INSTRUCTIONS

For any inquiries on a UV unit or system, contact:
 Robert Smith
 146 Barr St, Saint-Laurent
 Quebec, CA, H4T 1Y4
 1-888-726-8869
 techsupport@sanuvox.com

Installation Date: _____ Installed by: _____

Installer Contact Info.: _____

TABLE OF CONTENTS

△ IMPORTANT SAFETY INSTRUCTIONS △	1
TABLE OF CONTENTS	2
ABOUT THE PRODUCT	3
COMPONENTS	3
How it Works	3
ACCESSORIES & KITS	3
SETUP & INSTALLATION	4
What you will need	4
What's included	4
Special considerations for integrated system installation	4
Step by Step Setup UV Lamp & Filters	4
Versatile Installations	6
Step by Step Installation Stand-Alone	7
Step by Step Installation Duct-Mounted (Bypass)	8
Step by Step Installation Added Ducts	9
OPERATION	10
How to Operate your Product	10
How to Select Speed	10
How to Read the LED Status Display	10
MAINTENANCE	11
How to Replace Lamp	11
Step by Step Lamp Replacement	11
How to Replace Filters	12
Step by Step Filter Replacement	12
How to Clean your Product	13
STORAGE	13
ULTRAVIOLETS	13
ELECTRICAL RATINGS, POWER CONSUMPTION & AVAILABLE VOLTAGE	13
TROUBLESHOOTING	13
Problems & Solutions Table	13
WARRANTY	14
CUSTOMER SERVICE	14

ABOUT THE PRODUCT

The Sanuvair® S300 is designed to help reduce airborne microorganisms, as well as odors caused by some of these microorganisms (ex.: mold). UV light helps reduce microorganisms in the air flowing through that unit.

For information or recommendations on how to size your specific application, please call SANUVOX at 1-888-726-8869.

COMPONENTS

How it Works

The Sanuvair® S300 is comprised of a ventilator, speed selection switch, one UV ‘J’ lamp, two stage of filtration and the cabinet enclosure. The ventilator pulls air in, exposing it first to the UV lamps, then through the prefilters, and finally through the HEPA filter, which helps reduce 99.97% of particles of 0.3 microns or larger.

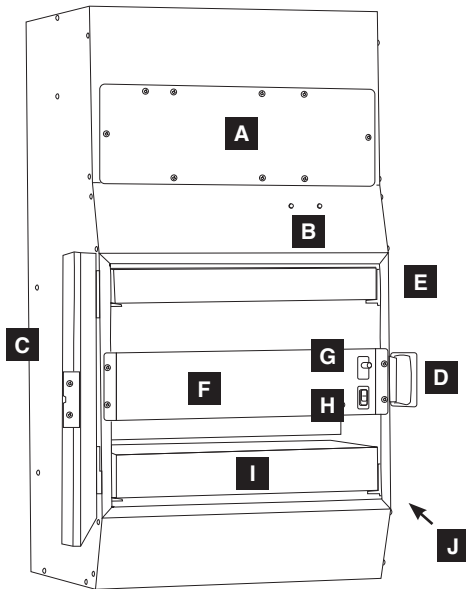

- A. Lamp & Ballast Access Door
(Plate must be installed once lamp setup are done.)
- B. LED Status Display
- C. Filters and Motor Access Door
- D. Door Latch
- E. Prefilter
- F. Motor
- G. Door Interlock Switch
- H. Speed Selection Switch
- I. HEPA Filter
- J. Power Cord Connector (on the side)

ACCESSORIES & KITS

The following optional accessories and/or kits work great with your product (sold separately).

Air inlet/outlet louver(s)
#MEC-LOU-1

Accessories made to facilitate Sanuvair® S300 stand-alone installation.

8" Collar(s)
#MSC-COL-1

Accessories made to facilitate Sanuvair® S300 added duct installation.

For instruction manuals or information about your optional accessories and/or kits, please call SANUVOX at 1-888-726-8869 or visit www.sanuvox.com.

SETUP & INSTALLATION

What you will need

Utility knife, scissors, wire cutters, air inlet grid (optional), air outlet grid (optional), suitable wall plugs and screws (as needed), screwdriver, pliers, masking tape, felt pen, two 8" collars (optional) and suspensions rods (optional).

⚠ **CAUTION:** Handle your product with care to avoid breaking parts. Make sure you have a free and safe space to unpack, install and setup your product. Confirm you have access to the necessary power source for the product requirements (see unit or system label). If you have any questions regarding the installation instructions, call SANUVOX at 1-888-726-8869.

What's included

The SANUVAIR® S300, a MERV8 prefilter, a HEPA filter, a UV lamp, the access door for the lamp and ballast (white metal plate) and a basic installation kit.

The installation kit includes: a pair of cotton gloves, a paper template for duct installation, 17" mounting angles (2), a 3-prong power cord (6'), self-adhesive foam tape for sealing openings (8') and self tapping 8/32 x 1/2 screws for the front plate (6).

Special considerations for integrated system installation

- Verify clearance on the ductwork to mount the unity using the Forced Air/Heating Cooling system;
- Respect minimum clearance requirement for maintenance and service;
- Electrical power requirements;
- Interaction between the HEPA/UV air purifier unit and other mechanical devices.

Step by Step Setup | UV Lamp & Filters



1. **Open the filters and motor access door** of your S300 unit: this is the large square door closed by the big black clamp.



2. **Check the filters (2):** If they are covered with plastic wrap, **be sure to unpack them** before proceeding.

NOTE: Make sure to install filter(s) according to air flow direction for maximum performance.



3. Under the HEPA filter is the cardboard sleeve containing the UV lamp. **Carefully slide the UV lamp out from the cardboard sleeve.** Be sure to wear the cotton gloves (included) ensuring the lamp is free from fingerprints.

NOTE: Fingerprints on the lamp will negatively impact the UV output of the lamp.

STEP 4



4. While holding the UV lamp by its porcelain end-cap, slide it into the rectangular opening in the front of the unit (above the filters and motor access door).

STEP 5



5. Carefully push the white connector onto the four pins. The plug is designed so it can only be installed one way. You may have to rotate the socket 90° to line up the pins with the holes. The connector will fit into position.

NOTE: Too much force applied from the opposite end-cap may break the lamp.

STEP 6



6. Then, slide the porcelain tip through the retention clamp.

NOTE: Make sure the lamp is horizontal in this section and not touching the metal walls.

STEP 7



7. Take **the access door for the lamp and ballast** from the supplied accessories and position it **over the rectangular opening**. Secure the plate in place with the 6 screws provided for this purpose.

STEP 8



8. **Close the filters and motor access door** of your S300 unit.

You are now ready to install your S300 unit in one of the three suggested installation types.

Versatile Installations

The SANUVAIR® S300 unit can be installed three ways: stand-alone (with protective grids at the air inlets and outlets), duct-mounted (bypass) OR with added ducts (using 8" collars).

In a commercial setting, the S300 unit can be positioned horizontally or vertically, on a wall or on a ceiling (with angles and suspension rods). In a residential environment, a ceiling installation with suspension rods is NOT recommended.

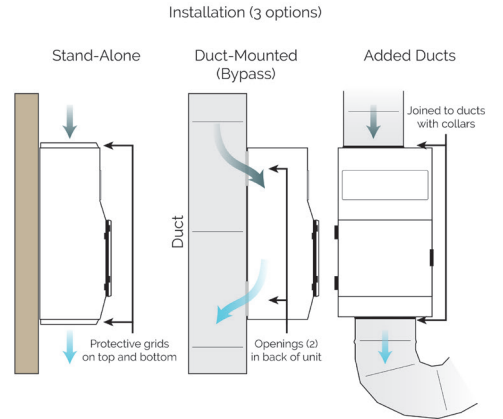

Versatile unit that can be positioned horizontally or vertically

Stand-Alone (attic)

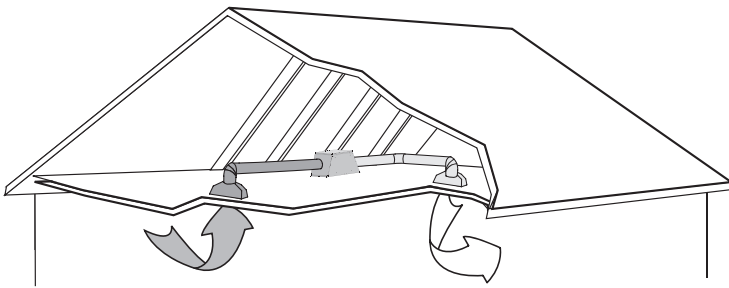

Stand-Alone (basement)

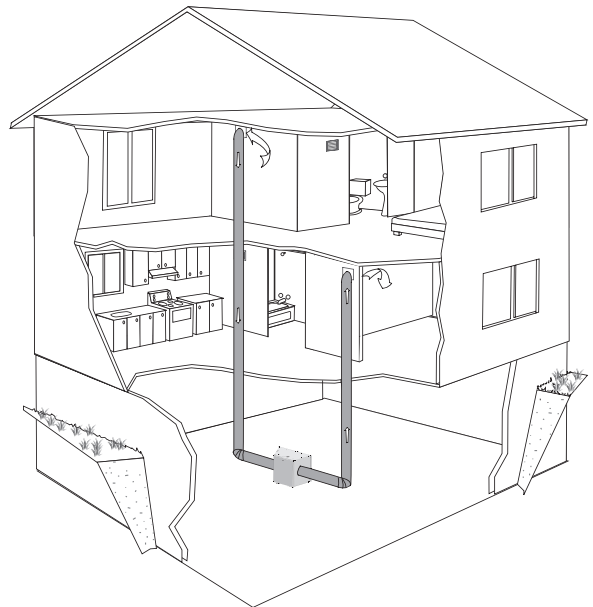

Duct-Mounted (Bypass)

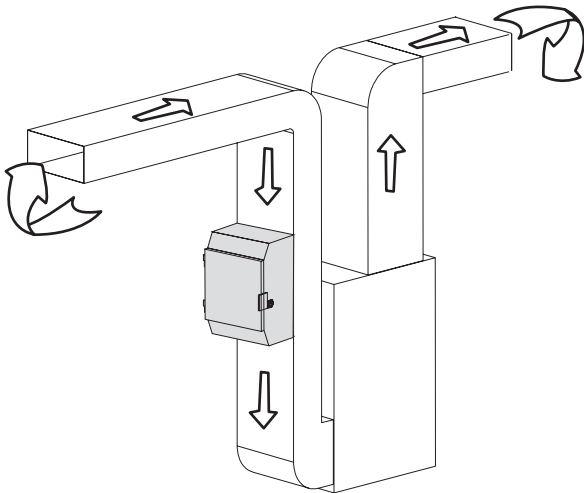

Added Ducts

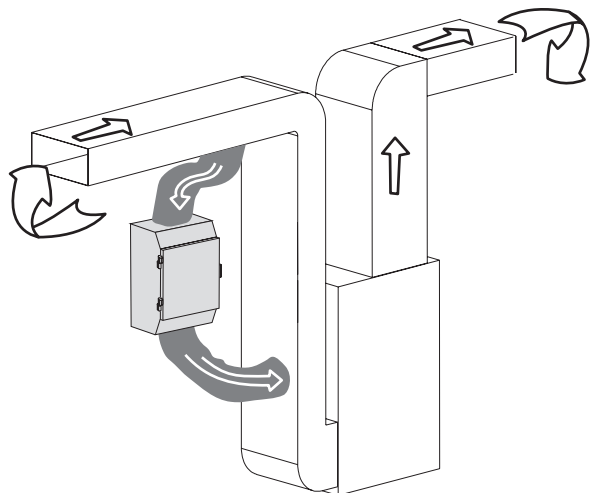

Step by Step Installation | Stand-Alone

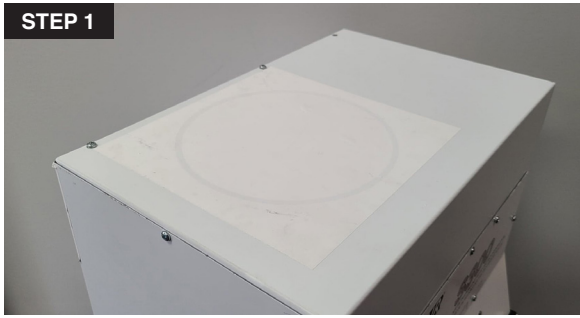

1. Using wire cutters, **cut the small metal pieces** supporting the pre-cut 8" round opening at the top of the unit and, do the same with the one underneath. You will need to use a blade to cut the paper on top as well as the sound-absorbing material under the unit.

⚠ **CAUTION:** The metal is sharp. Gently remove this part to avoid injuring yourself.

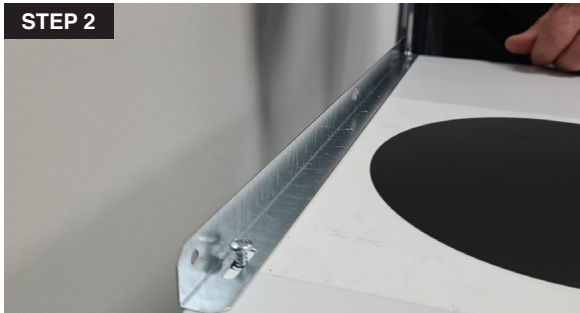

2. Use one of the **17" mounting angles** and secure it along the rear edge of the unit top by using the screws already in place. Then, secure the second mounting angle along the rear edge at the bottom of the unit.

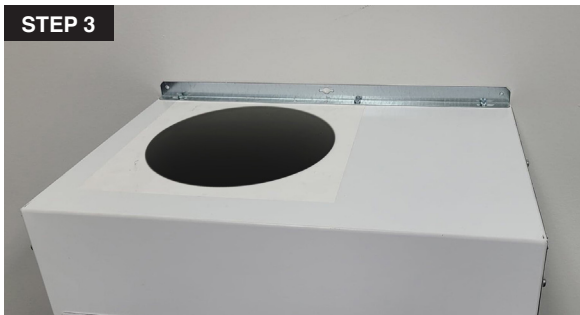

3. **Secure the unit to the wall** (vertically or horizontally) **or to the ceiling**, using suitable wall plugs and screws (not included). Make sure you have a power outlet nearby to plug the unit into.

⚠ **CAUTION:** Your S300 unit is bulky. Make sure that there are **always two people** to lift and handle it to avoid any injuries.

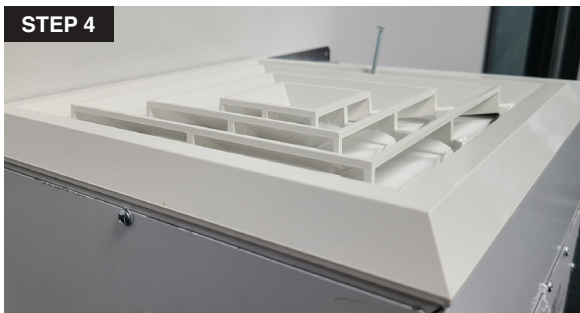

4. Then **place an air inlet grid (sold separately)** over the opening you made at the top: this grid will rest against the mounting angle to lock it in place.

Do the same for the air outlet under the unit.

**Your new SANUVAIR® S300
is now ready to operate!**

Step by Step Installation | Duct-Mounted (Bypass)



1. Locate the two 4" x 17" pre-cut rectangular openings at the back of the unit (one at the top, one at the bottom).



2. Use pliers and/or your hands to **unfold the metal pieces of both openings and position them 90°** from the back of the unit.

Proceed for both openings.



3. Use one of the **17" mounting angles** and secure it along the rear edge of the unit top by using the screws already in place. Then, secure the second mounting angle along the rear edge at the bottom of the unit.



4. Use the **self-adhesive foam tape** and stick it **around the outline of the two back openings** to ensure their tightness when the unit is attached to the pipe. You will probably need to cut the tape into pieces to form the two tape rectangles.

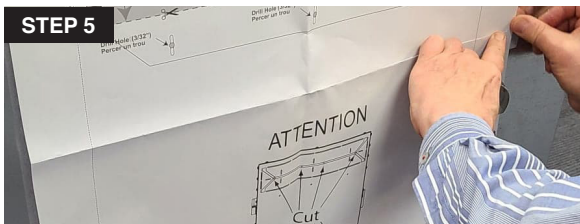

5. Unfold the **paper template** and position it on the ventilation duct where you want to attach the unit. Tape it in place with masking tape.

You can identify the openings to make by using a felt pen, or directly cut the duct with the paper template in place.

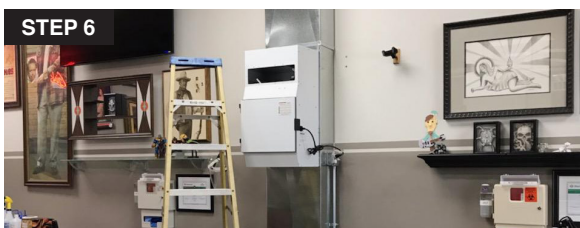

6. Once the openings are cut into the duct, be sure to remove the paper template if you haven't already done so. These two openings will be used to receive the air inlet and outlet vents that you have made at the rear of the unit.



7. **Install the unit vertically on the duct, aligning the openings.** Secure the unit in place with the self-tapping screws provided for this purpose. Make sure you have a power outlet nearby to plug the unit into.

⚠ CAUTION: Your S300 unit is bulky. Make sure that there are **always two people** to lift and handle it to avoid any injuries.

**Your new SANUVAIR® S300
is now ready to operate!**

Step by Step Installation | Added Ducts

STEP 1

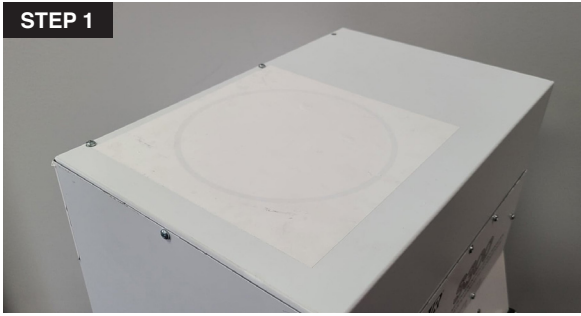

1. Using wire cutters, **cut the small metal pieces** supporting the pre-cut 8" round opening at the top of the unit and, do the same with the one underneath. You will need to use a blade to cut the paper on top as well as the sound-absorbing material under the unit.

⚠ **CAUTION:** The metal is sharp. Gently remove this part to avoid injuring yourself.

STEP 2

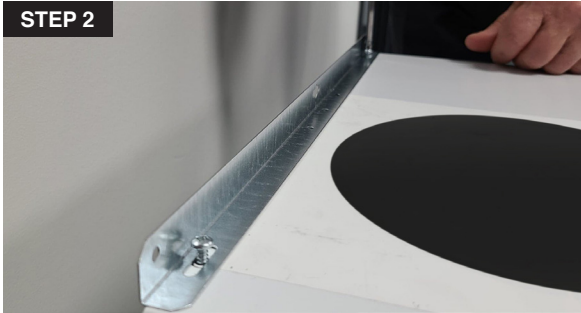

2. Use one of the **17" mounting angles** and secure it along the rear edge of the unit top by using the screws already in place. Then, secure the second mounting angle along the rear edge at the bottom of the unit.

STEP 3



3. **Secure the unit to the wall** (vertically or horizontally) **or to the ceiling**, using suitable wall plugs and screws (not included). Make sure you have a power outlet nearby to plug the unit into.

⚠ **CAUTION:** Your S300 unit is bulky. Make sure that there are **always two people** to lift and handle it to avoid any injuries.

STEP 4

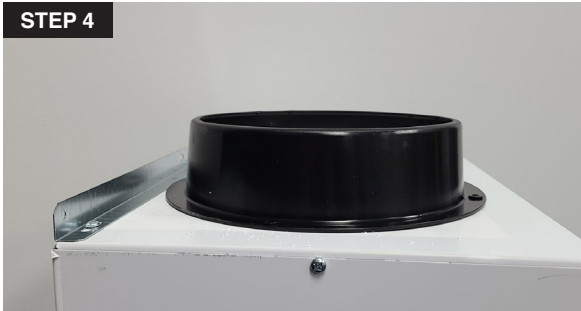

4. Then **place a 8" collar (sold separately)** over the opening you made at the top to later connect rigid pipe or 8" flexible pipe.

Do the same for the air outlet under the unit.

STEP 5

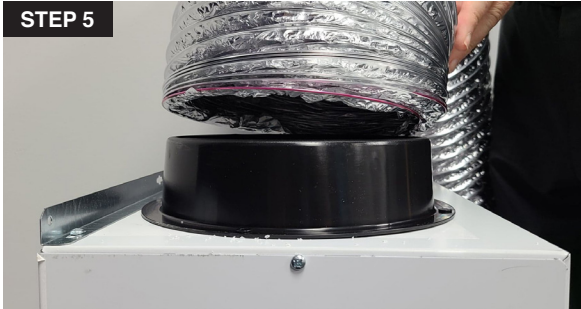

5. **Install your 8"** (rigid in aluminum or galvanized or aluminized flexible) **pipes.**

**Your new SANUVAIR® S300
is now ready to operate!**

OPERATION

How to Operate your Product

The Sanuvair® S300 is an automatic unit: once it's installed and plugged in, simply press the power switch to turn it ON.

To access the door interlock switch and the speed selection switch, open the filters and motor access door at the front of the unit. Opening the latch on the right side of the unit will permit the door to swing open. The safety door interlock switch cut the power to the motor. If necessary the door can be removed from the cabinet hinges by holding the top part of the door with one hand and gently tapping on the bottom edge of the door with your hand to release the door from its hinges.

How to Select Speed

The Sanuvair® S300 features two speeds of operation.

The speed selection switch is located inside the unit, on the front of the motor assembly.

It is recommended that the unit be operated at its highest speed at all time to maximize the benefits of the air purifier.

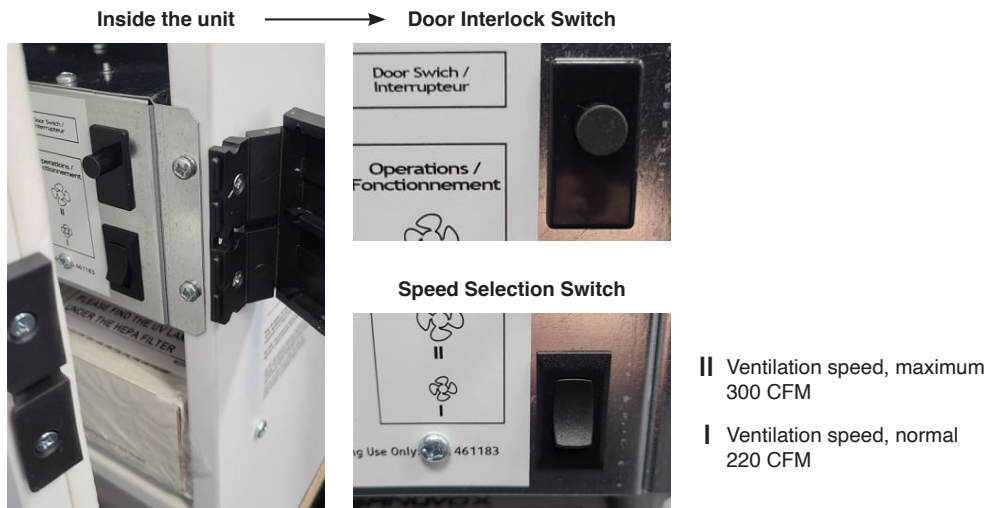

How to Read the LED Status Display

The Sanuvair® S300's LED Status Display will give you real time status update about your unit and its lamp.

Normal Operation

- **BALLAST ON, RED:** Ballast in operation, "Default Mode".
- **UV ON, AMBER:** Lamp in operation, "Default Mode".

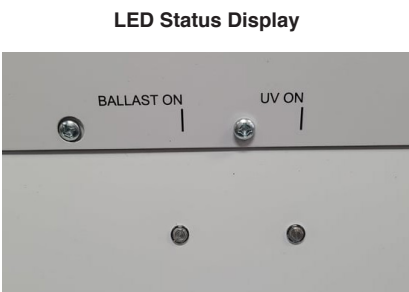

MAINTENANCE**How to Replace Lamp**

Replace UV lamp every 3 years (residential uses), or every 2 years (commercial uses).

Replacing lamp on the Sanuvair® S300 is quick and easy. Simply turn off the power source, unscrew and remove the lamp and ballast access door (plate), remove and dispose of old lamp, replace with new Sanuvox branded UV lamp, screw back the lamp and ballast access door (plate) and turn power source back on. See below for detailed step by step instructions.

⚠ **CAUTION:** In order to avoid reduced performance of lamp, do not touch lamp glass without gloves.

Step by Step Lamp Replacement

1. Unscrew and **remove the lamp and ballast access door** to access the old lamp.

⚠ **CAUTION:** Before installing or performing maintenance on the unit or system, **TURN OFF AND DISCONNECT the unit or system from all power sources.**



2. **Prepare the new lamp.** Remove the contents from packaging. Only after you have visually inspected the UV lamp should you break the security seal on the underside of the cardboard sleeve. Be sure to wear the **cotton gloves** (included) guaranteeing a clean lamp free from fingerprints. Fingerprints on the lamp will negatively impact the UV output of the lamp.

NOTE: Fingerprints on the lamp will negatively impact the UV output of the lamp.



3. While holding the new UV lamp by its porcelain end-cap, slide it into the rectangular opening in the front of the unit (above the filters and motor access door).

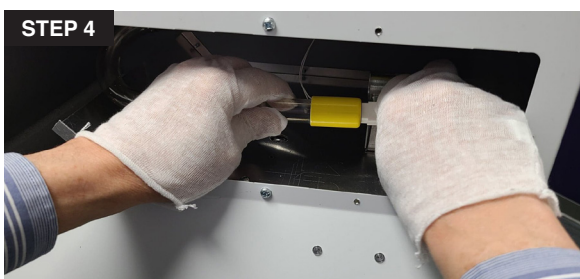

4. Carefully push the white connector onto the four pins. The plug is designed so it can only be installed one way. You may have to rotate the socket 90° to line up the pins with the holes. The connector will fit into position.

NOTE: Too much force applied from the opposite end-cap may break the lamp.



- Then, slide the porcelain tip through the retention clamp.

NOTE: Make sure the lamp is horizontal in this section and not touching the metal walls.

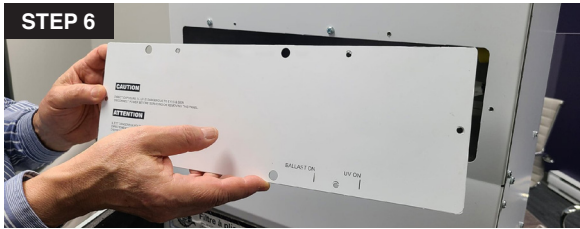

- Screw back in place the access door for the lamp and ballast over the rectangular opening.

How to Replace Filters

Replace prefilter every 3 to 6 months or as needed.

Replace HEPA filter every 1 to 3 years or as needed. Check regularly to maintain maximum performance of your HVAC system.

Step by Step Filter Replacement



- Open the filters and motor access door at the front of the unit.** Opening the latch on the right side of the unit will permit the door to swing open.

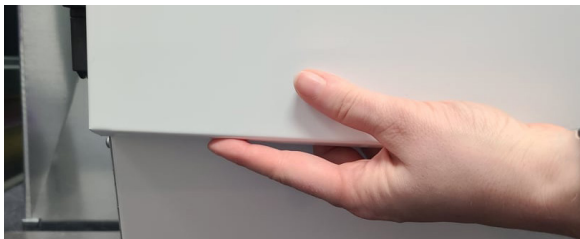

If necessary the door can be removed from the cabinet hinges by holding the top part of the door with one hand and gently tapping on the bottom edge of the door with your hand to release the door from its hinges.

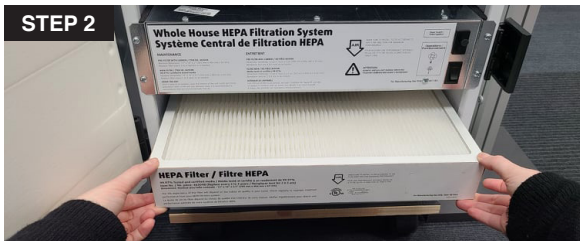

- After opening the unit's access door, **grasps both edges of the HEPA filter and pull with equal force to slide it out.**



- Unpack the new HEPA filter and place it in the unit, then close the access door. Repeat step 2 and 3 for the pre-filter, as needed.

NOTE: Make sure to install filters according to air flow direction for maximum performance.



How to Clean your Product

Maintenance of the unit should be performed at regular intervals to keep the benefits of the UV air purifier. For optimal performance, the lamp should be kept free of dust and residue deposit. Clean when necessary with mild soap or alcohol. Always spot test the cleaner to make sure it does not damage the surface. Once a year or as needed, clean the interior of the unit (wall and motor plate), with mild non-abrasive soap. It is recommended to use products that are environmentally friendly.

⚠ CAUTION: Under no circumstance should water be sprayed or splashed onto the product.

STORAGE

The Sanuvair® S300 unit is fixed installation and therefore, requires no specific storage.

ULTRAVIOLETS

Ultraviolet wavelengths (UV) emitted by Sanuvox units and systems are identical to ultraviolet produced by the sun. UVC damage nucleic acids (DNA/RNA) of microorganisms, which inactivates them. Unlike conventional UV lamps on the market, Sanuvox units and systems use a patented process that delivers a maximum dose of UV to the moving air stream or surfaces.

⚠ CAUTION: Never expose eyes or skin to an operating UV lamp.

ELECTRICAL RATINGS, POWER CONSUMPTION & AVAILABLE VOLTAGE

The Sanuvair® S300 has a power consumption of 180W. The product is rated at 120/240 VAC, 50/60 Hz. See product label to confirm power consumption of your specific unit or system.

NOTE: IF YOU EXPERIENCE A PROBLEM, PLEASE CONTACT CUSTOMER SERVICE FIRST OR SEE YOUR WARRANTY. DO NOT RETURN THE PRODUCT TO THE ORIGINAL PLACE OF PURCHASE. DO NOT ATTEMPT TO OPEN THE PRODUCT OR TAMPER WITH ITS COMPONENTS WITHOUT CONTACTING CUSTOMER SERVICE FIRST. DOING SO MAY VOID YOUR WARRANTY AND CAUSE PERSONAL INJURY OR DAMAGE TO THE PRODUCT.

TROUBLESHOOTING

If your product is not working properly, refer to the following.

Problem	Possible Cause	Solution
Unit doesn't turn ON.	<ul style="list-style-type: none"> - The power cord is not fully inserted in the unit's connector. - There is no power to the electrical outlet. - The door interlock switch is operating. - Power cord is damaged. 	<ul style="list-style-type: none"> - Test the outlet to make sure there is power by plugging in another electrical appliance. - Check the power cord for damage and replace if damaged.
Unit operates only on one speed.	<ul style="list-style-type: none"> - There are loose wires inside electrical box. 	<ul style="list-style-type: none"> - Contact your contractor.
Unit vibrates (balancing weight).	<ul style="list-style-type: none"> - An excessive dust build-up or missing on the impeller wheel. 	<ul style="list-style-type: none"> - Check for excessive dust build-up or missing on the impeller wheel. - Clean the interior of the unit (wall and motor plate)

**Contact your contractor for all your needs in terms of replacement parts:
power cord, motor, ventilator, ballast, UV lamp, etc.**

WARRANTY

You should first read all instructions before attempting to use this product. For this warranty to be valid, keep a copy of the proof of purchase.

REGISTER
YOUR WARRANTY
ONLINE AT
www.sanuvox.com



UV lamp	2 years (commercial), 3 years (residential)
Ballast	3 years
Electric Motor	3 years

- A. This limited warranty applies to repair or replacement of product found to be defective in material or workmanship. This warranty does not apply to damage resulting from abusive, unreasonable use or supplemental damage. Defects that are the result of normal wear and tear will not be considered manufacturing defects under this warranty.
SANUVOX IS NOT LIABLE FOR INCIDENTAL OR CONSEQUENTIAL DAMAGES OF ANY NATURE, ANY IMPLIED WARRANTY OF MERCHANTABILITY OR FITNESS FOR A PARTICULAR PURPOSE ON THIS PRODUCT IS LIMITED IN DURATION TO THE DURATION OF THIS WARRANTY.
 Some jurisdictions **do not** allow the exclusion or limitation of incidental or consequential damages or limitation on how long an implied warranty last, so the above limitations or exclusions may not apply to you. This warranty gives specific legal rights, and you also may have other rights which vary from jurisdiction to jurisdiction. This warranty applies only to the original purchaser of this product from the original date of purchase.
- B. At its option, SANUVOX will repair or replace this product if it is found to be defective in material or workmanship.
- C. This warranty does not cover damage resulting from any unauthorized attempts to repair or from any use not in accordance with the instruction manual.
- D. This warranty does not cover the filters, prefilters or other accessories (if included), except for material or workmanship defects.

Call us toll-free at 1-888-726-8869 or email: info@sanuvox.com

Please be sure to specify product name.

NOTE: IF YOU EXPERIENCE A PROBLEM, PLEASE CONTACT CUSTOMER SERVICE FIRST OR SEE YOUR WARRANTY. DO NOT RETURN THE PRODUCT TO THE ORIGINAL PLACE OF PURCHASE. DO NOT ATTEMPT TO OPEN THE PRODUCT OR TAMPER WITH ITS COMPONENTS WITHOUT CONTACTING CUSTOMER SERVICE FIRST. DOING SO MAY VOID YOUR WARRANTY AND CAUSE PERSONAL INJURY OR DAMAGE TO THE PRODUCT.

CUSTOMER SERVICE

TO ORDER REPLACEMENT PARTS

PLEASE CONTACT YOUR CONTRACTOR OR SANUVOX CUSTOMER SERVICE

Toll-Free Phone #: 1-888-726-8869

Email: info@sanuvox.com

Website: www.sanuvox.com

Please be sure to specify product name.

Replacement parts for this product

BST120/277GL	Ballast with multi-voltage input of 120-277 VAC, 50/60 Hz
LMPHGJ105	T6 High Intensity 10.5" 'J' shaped UVC lamp, germicidal (purple caps)
LMPHGJ105	T6 High Intensity 10.5" 'J' shaped dual UVC/UVV lamp, for odor reduction (yellow caps)
FTR-10	MERV8 Prefilter or the carbon MERV8 prefilter # FTR-10A
FTR-11	HEPA filter
MEC-LOU-1	Air inlet/outlet louver
MSC-COL-1	8" collar

⚠ WARNING: Use only specified SANUVOX branded replacement UV lamps with your unit or system. Use of any other lamps will void your warranty and can result in damage to the unit, system and/or lamp(s).